

# 1689/1689M Precision RLC Digibridge(R)

## Instruction Manual Fom11689-0120-06/D2

(C)QuadTech, Inc., 1992  
5 Clock Tower Place, 210 East  
Maynard, Massachusetts, U.S.A. 01754  
March, 2000  
Telephone 978-461-2100  
Sales 800-253-1230  
Facsimile 978-461-4295  
Website www.quadtech.com

The material in this manual is for informational purposes only and is subject to change, without notice. QuadTech assumes no responsibility for any error or for consequential damages that may result from the misinterpretation of any procedures in this publication.

## Contents

Specifications  
Warranty  
Introduction -Section 1  
Installation - Section 2  
Operation -Section 3  
Theory -Section 4  
Service and Maintenance -Section 5  
Parts Lists and Diagrams -Section 6



Product will be marked with this symbol (ISO#3684) when it is necessary for the user to refer to the instruction manual in order to prevent injury or equipment damage.



Product marked with this symbol (IEC417) indicates presence of direct current.

---

# Instruction Manual Changes

---

These supplementary pages contain information of improvements or modifications not documented in the current manual. All references to GenRad in the manual now apply to QuadTech, Inc.

## Page v - Table of Contents (Parts Lists and Diagrams - Section 6)

- Power supply assembly, board layout and schematic (pages 6-15 & 6-16) replaced by Power supply assembly part number 700011.

## Page xii - Specifications (High-Speed Measurement/Interface Option, Environment Power & Mechanical)

- Part Number for High-Speed Measurement /Interface Option should be 1689-9630.
- Power should be 90 - 250Vac, 50 - 60 Hz. Voltage switching is automatic and no longer selected by rear panel switch. 60 watts maximum.
- Weight: 1689 should be 10 lbs. (4.5 kg)  
1689M should be 14 lbs. (6.4 kg)
- Environment reads, Altitude <2000m, Installation Category 1, Pollution Degree 1

## Page 1-8 - Figure 1-3 & Figure 1-4, 1689 and 1689M Rear View

- Rear view should show new power supply assembly (PN 700011) without line-voltage switch.

## Page 1-9 - Table 1-2, Rear Connectors and Controls

- Ref No. 1 -  External bias connector receives cable 1658-2450 (not supplied with instruments shipped after July 97, available on request). Fuse is 2/10A, 250V, 3AG Type, Fast Blow. Replace only with the same type and rating.
- Ref No. 3 - Air filter has been deleted.

- Ref No. 5 -  Fuse is 6/10A, 250V, 3AG Type, Slow Blow. Replace only with the same type and rating. To replace, remove fuse drawer by pressing up on release tab.
- Ref No. 6 - Line-voltage switch has been deleted, power input is from 90 - 250V AC.

## Page 1-11, 1-12 - Table 1-3, 1-4 Accessories and Options for the 1689/1689M

- A quantity of two spare fuses are supplied, 6/10A, 250V, 3AG Type, Slow Blow (QuadTech part number 5330-1100)
- Bias cable 1658-2450 with built-in fuse (not supplied with instruments shipped after July 97, available on request). A quantity of one spare fuse is supplied, 2/10A, 250V, 3AG Type, Fast Blow (QuadTech part number 5330-3200)
- Part number for the recommended High-Speed Measurement/Interface Option has changed from 1689-9620 to 1689-9630.

## Page 2-1 - Safety Inspection

 Before operating the instrument inspect the power inlet module on the rear of the unit to ensure that the **properly rated fuse is in place**, otherwise damage to unit is possible. Fuse is 6/10A, 250V, 3AG Type, Slow Blow.

# Instruction Manual Changes (continued)

The 1689 is shipped with a standard U.S. power cord, QuadTech PN 4200-0300 (with Belden SPH-386 socket or equivalent, and 3 wire plug conforming to IEC 320) or an approved international cord set. Make sure the instrument is only used with these or other approved international cord sets, which ensures the instrument is provided with **connection to protective earth ground**.

In all installations the instrument should be positioned with consideration for **ample air flow** to the side and rear panel ventilation holes. An open space around the instrument of at least 3 inches (75mm) is recommend. The surrounding environment should be **free from excessive dust** to prevent contamination of electronic circuits.

## WARNING

**If this instrument is used in a manner not specified in this manual protection to the operator and equipment may be impaired.**

### Page 2-2 - Power-Line Connection

- Power line switch for 115V or 230V operation has been removed, switching is automatic for voltages between 90 - 250V AC.
- Figure 2-2 does not apply. Only certified line cords which comply with IEC 227 or IEC 245 should be used.

### Page 2-4 - Paragraph 2.6.2, External Bias

- Bias cable 1658-2450, (not supplied with instruments shipped after July 97, available on request).

### Page 2-5 - Paragraph 2.7.1, High-Speed Measurement/Interface Option

- Part number for the High-Speed Measurement/Interface Option has changed from 1689-9620 to 1689-9630.

### Page 3-1 - Paragraph 3.1.2 Startup, step a

- Power line switch for 115V or 230V operation has been removed, switching is automatic.

### Page 3-64 - Paragraph 3.12 Data Output and/or Programming via IEEE-488 Bus

- Part number for the High-Speed Measurement/Interface Option has changed from 1689-9620 to 1689-9630.

### Page 5-3 - Paragraph 5.3, Repair and Replacement of Circuit Boards

- Contacts for QuadTech are:  
Sales & Service 800-253-1230  
Technical Assistance 978-461-2100

### Page 5-4 - Table 5-1, Caution Note

- Power line switch for 115V or 230V operation has been removed, switching is automatic.

### Page 5-11 - Figure 5-1, 1689 Rear and Bottom View

- Rear view should show new power supply assembly (PN 700011) without line-voltage switch.

### Page 5-13 - Paragraph 5.5.1, Disassembly of 1689 Digibridge, step e and f

- Delete step e, there is no longer a protective cover. CAUTION note does not apply, the fan has been removed.
- Step f, the power supply is secured by only 4 screws rather than 5.

## Instruction Manual Changes (continued)

### **Page 5-14 & Page 5-15 - Figure 5-3 & Figure 5-5, Power Supply Assembly**

- Power Supply Assembly shown, PN 1689-2005, has been replaced by Power Supply Assembly, PN 700011.

### **Page 5-18 - Paragraph 5.5.2, Disassembly of 1689M Digibridge, step b**

- Access to the bottom of the main board as detailed in step b and step h is no longer possible on late version instruments. The access panel has been deleted and the bottom of the instrument is now a solid panel.

### **Page 5-19 - Paragraph 5.5.2, Disassembly of 1689M Digibridge, step d**

- Delete step d, there is no longer a foam-plastic air filter.

### **Page 5-20 - Figure 5-11, Interior Top View**

- Power Supply Assembly shown, PN 1689-2005, has been replaced by Power Supply Assembly, PN 700011.

### **Page 5-21 - Paragraph 5.5.2, Disassembly of 1689M Digibridge**

- Delete step (2), there is no longer a protective cover.
- Step (3), the cable to the right may be secured to the power supply frame with a cable tie. The tie needs to be removed before removing the power supply from the unit.
- Step (4), the power supply is secured by only 4 screws rather than 5. CAUTION note does not apply, the fan has been removed.

### **Page 5-22 - Paragraph 5.5.3, Relocation of BNC Connector Bracket**

- Access to the bottom of the main board as detailed in **step b** is no longer possible on late version instruments. The access panel has been deleted and the bottom of the instrument is now a solid panel. Relocation of the BNC connector bracket is only possible by removing the main board as detailed in Paragraph 5.5.2, step k.

### **Page 5-25 - Figure 5-14, High-Speed Measurement & IEEE/Handler Interface Opt**

- Interface option shown, PN 1689-9620, has been replaced by PN 1689-9630.

### **Page 5-26 - Instrument Cleaning Instructions**

- Monthly (more or less depending on usage) the built-in test fixture should be cleaned with a soft brush and isopropyl alcohol. Avoid getting excess alcohol on instrument paint surfaces, otherwise damage to the finish can result. For additional instrument cleaning instructions refer to paragraph 5.6.1 (Care of the Test Fixture) and paragraph 5.6.3 (Care of the Display Panel).

### **Page 5-28 - Paragraph 5.6.2, Cleaning Air Filter**

- Delete paragraph, air filter has been removed.

### **Page 5-34 - Paragraph 5.7.4, Power supply**

- Trouble analysis Procedure does not apply to the new Power Supply Assembly. PN 700011.

## Instruction Manual Changes (continued)

Page 5-41 -Table 5-7, Capacitance Accuracy Checks

.QDR Display Max column corrected as follows:

Nominal Value	<u>QDR Max</u>
10 pF	6100 ppm
100 pF	2500 ppm
1500 pF	700 ppm
1500 pF	1000 ppm
1500 pF	1700 ppm
6400 pF	500 ppm
10 nF	500 ppm
25 nF	500 ppm
25 nF	800 ppm
25 nF	1500 ppm
100 nF	500 ppm
200 nF	600 ppm
400 nF	600 ppm
400 nF	900 ppm
400 nF	1600 ppm
1000 nF	600 ppm

Page 6-2 -Figure 6-2, 1689 Rear View

**Rear** view should show new power supply assembly (PN 700011) without line voltage switch.

Page 6-3 -Mechanical Parts List for 1689, Rear

**Items** 4 through 7 (power connector, fuse extractor post and line voltage switch and cover) deleted on new power supply assembly.

Page 6-4 -Figure 6-2(A), 1689M Rear View

**Rear** view should show new power supply assembly (PN 700011) without line voltage switch.

Page 6-5 -Mechanical Parts List for 1689M, Rear

**Items** 3 through 6 (power connector, fuse extractor post, line voltage switch and cover) deleted on new power supply assembly.

Page 6-15 & Page 6-16 -Parts Lists and Diagrams

**Power** Supply Assembly shown, PN 1689-2005, has been replaced by Power Supply Assembly, PN 700011. The 700011 Assembly must be repaired by module exchange.

Page 6-19, 6-20, 6-21, & 6-22 -Parts Lists and Diagrams

**High-speed** interface board shown, PN 1689-4720, has been replaced by PN 1689 4620. See instructions supplied with the 1689-9630.

# Table of Contents

<p>SPECIFICATIONS . . . . . v</p> <p>WARRANTY . . . . . xvii</p> <p style="text-align: center;">INTRODUCTION -- SECTION 1</p> <p>1.1 PURPOSE . . . . . 1-1</p> <p>1.2 GENERAL DESCRIPTION . . . . . 1-2</p> <p>    .1 Basic Digibridge 1689 . . . . . 2</p> <p>    .2 Basic Digibridge 1689M . . . . . 2</p> <p>    .3 Interface Options . . . . . 3</p> <p>    .4 References . . . . . 3</p> <p>1.3 CONTROLS, INDICATORS, etc. . . . . 1-3</p> <p>1.4 ACCESSORIES . . . . . 1-10</p> <p>CONDENSED OPERATING INSTRUCTIONS . . . . . 1-14</p> <p style="text-align: center;">INSTALLATION -- SECTION 2</p> <p>2.1 UNPACKING AND INSPECTION . . . . . 2-1</p> <p>2.2 DIMENSIONS . . . . . 2-1</p> <p>2.3 POWER-LINE CONNECTION . . . . . 2-2</p> <p>2.4 LINE-VOLTAGE REGULATION . . . . . 2-3</p> <p>2.5 TEST-FIXTURE CONNECTIONS . . . . . 2-3</p> <p>    .1 For 1689 . . . . . 3</p> <p>    .2 For 1689M . . . . . 4</p> <p>2.6 BIAS VOLTAGE FOR THE DUT . . . . . 2-4</p> <p>    .1 Internal Bias . . . . . 4</p> <p>    .2 External Bias . . . . . 4</p> <p>2.7 HANDLER INTERFACE (OPTION) . . . . . 2-5</p> <p>    .1 ..via High-Speed Option . . . . . 5</p> <p>    .2 ..via Regular-Speed Option . . . . . 6</p> <p>    .3 Timing . . . . . 7</p> <p>2.8 IEEE-488 INTERFACE (OPTION) . . . . . 2-9</p> <p>    .1 Purpose . . . . . 9</p> <p>    .2 Interface Functions . . . . . 10</p> <p>    .3 Signal Identification . . . . . 11</p> <p>    .4 Codes and Addresses . . . . . 13</p> <p>2.9 ENVIRONMENT . . . . . 2-15</p> <p>2.10 RACK MOUNTING . . . . . 2-15</p>	<p style="text-align: center;">OPERATION -- SECTION 3</p> <p>3.1 BASIC PROCEDURE . . . . . 3-1</p> <p>    .1 General . . . . . 1</p> <p>    .2 Startup . . . . . 1</p> <p>    .3 Zeroing . . . . . 2</p> <p>    .4 Routine Measurement . . . . . 3</p> <p>3.2 CONNECTING THE DUT . . . . . 3-4</p> <p>    .1 General . . . . . 4</p> <p>    .2 Integral Test Fixture (Radial) . . . . . 4</p> <p>    .3 Using Adaptors (Axial-Lead DUT) . . . . . 5</p> <p>    .4 BNC Adaptors, Remote Fixture . . . . . 8</p> <p>    .5 Extender Cable (Type 874) . . . . . 9</p> <p>    .6 Extender Cable (Banana Plugs) . . . . . 10</p> <p>    .7 Effects of Cable Capacitances . . . . . 11</p> <p>    .8 Tweezers (Special Test Fixture) . . . . . 12</p> <p>    .9 Kelvin Clips . . . . . 13</p> <p>3.3 MEASUREMENT PARAMETERS, RESULTS DISPLAYS, OUTPUTS . . . . . 3-13</p> <p>    .1 Parameters (R L C Q D) . . . . . 13</p> <p>    .2 Equiv Curcuits (Series, Paral) . . . . . 14</p> <p>    .3 Results PRINCIPAL MEASUREMENT . . . . . 17</p> <p>        SECONDARY MEASUREMENT . . . . . 18</p> <p>        GO/NO-GO . . . . . 19</p> <p>    .4 Units, Multipliers, Blank Disp . . . . . 19</p> <p>    .5 D/Q in PFM . . . . . 20</p> <p>    .6 Digit Blanking (Special Funct) . . . . . 21</p> <p>    .7 Ratio Displays (Special Funct) . . . . . 21</p> <p>3.4 PRINCIPAL TEST CONDITIONS . . . . . 3-23</p> <p>    .1 Test Frequency . . . . . 23</p> <p>    .2 Test Voltage . . . . . 24</p> <p>    .3 Constant-Voltage Source . . . . . 25</p> <p>    .4 Constant-Current Source . . . . . 25</p> <p>    .5 Other Conditions . . . . . 26</p> <p>3.5 MEASUREMENT TIME AND MEASUREMENT RANGES . . . . . 3-26</p> <p>    .1 General . . . . . 26</p> <p>    .2 Measure Rate Selection (Keybrd) . . . . . 28</p> <p>    .3 Settling Time, Programmed Delay . . . . . 28</p> <p>    .4 Measure Mode &amp; Display Effects . . . . . 29</p>
---	--

.5	Integration-Time Factor	29
.6	Ranges (Changing, Holding, Time)	30
.7	Time: Median Values, Averaging	32
.8	Time: IEEE-488 Bus Output	33
.9	Time: Low Test Frequency	33
.10	Measurement Time Summary	34
3.6	ACCURACY, THE LIMITS OF ERRORS	3-36
.1	General	36
.2	Accuracy for Typical Conditions	36
.3	Averaging to Improve Accuracy	38
.4	Median Value, For Better Acc'y	39
.5	Enhancement for Large & Small Z	39
.6	Enhancement by Short Ckt L	40
.7	Cable-Related Errors	41
.8	Signal Reversing for Power Freq	44
3.7	BIAS FOR THE DUT	3-45
.1	Internal Bias	45
.2	External Bias	46
.3	Suppression of Transients	49
3.8	BIN SORTING & GO/NO-GO RESULTS	3-49
.1	Introduction to Binning	49
.2	Sorting Methods	50
.3	Limit Entry Procedure	51
.4	Verification of Nominal & Limits	52
.5	Examples of Limit Entry	53
.6	Notes on Limit Entries, General	54
.7	Go/No-Go and Bin Results	55
.8	Bin Sum Information	55
.9	Binning and Ratio Meas Together	56
3.9	KEYBOARD LOCK, FUNCTION MAP AND INTERROGATIONS	3-58
.1	Keyboard Lock	58
.2	Function Map	59
.3	Summary of Interrogations	59
3.10	SPECIAL FUNCTIONS	3-60
3.11	OPERATION WITH A HANDLER	3-63
3.12	DATA OUTPUT AND/OR PROGRAMMING VIA IEEE-488 BUS	3-64
.1	IEEE-488 Interface Unused	64
.2	Talk-Only Use, for Data Output	64
.3	Talk/Listen Use, Programming etc	70
.4	Output in Compact Binary Format	78
3.13	SELF CHECKS AND FAILURE DISPLAYS (ERROR CODES)	3-81
.1	Power-Up Self Checks	81
.2	Failure due to Signal Overload	82
.3	...due to Abnormal Meas Cycle	82
.4	...due to LC Resonance	82
3.14	SAMPLE IEEE PROGRAMS	3-83
.1	Programming Hints	83
.2	Hewlett Packard HP85	84
.3	Capitol Equipm't PC-488/IBM-PC	84
.4	Nat'l Instrm't GPIB-PCII/IBM-PC	85

THEORY -- SECTION 4

4.1	INTRODUCTION	4-1
.1	General	1
.2	Brief Description of 1689	1
.3	Block Diagram	2
4.2	PRINCIPAL FUNCTIONS	4-4
.1	Elementary Measurement Circuit	4
.2	Frequency and Time Source	5
.3	Sine-Wave Generation	5
.4	Dual-Slope Integrating Detector	6

SERVICE -- SECTION 5

5.1	CUSTOMER SERVICE	5-3
5.2	INSTRUMENT RETURN	5-3
.1	Return Material	3
.2	Packaging	3
5.3	REPAIR & REPLACEMENT OF BOARDS	5-3
5.4	PERFORMANCE VERIFICATION	5-3
.1	General	3
.2	Performance verification	4
.3	Measurement-Time Checkout	8
5.5	DISASSEMBLY AND ACCESS	5-11
.1	Disassembly 1689	12
.2	Disassembly 1689M	18
.3	Relocation of BNC Connector Bkt	22
.4	Access to Internal Components	23
.5	IEEE/Handler Interface Options	25
.6	Removal of Multiple-Pin Packages	26
5.6	PERIODIC MAINTENANCE	5-26
.1	Care of Test Fixture	26
.2	Cleaning Air Filter	28
.3	Care of Display Panel	28
5.7	TROUBLE ANALYSIS	5-28
.1	General	28
.2	Power-Up Self Checks	30
.3	Battery and Fuse Replacement	33
.4	Power Supply	34
.5	Sinewave Generator Checks	35
.6	Front End Amplifiers, Switches	36
5.8	ACCURACY VERIFICATION	5-38
.1	General	38
.2	C Meas'mt Acc'cy, Ranges 1 2 3	39
.3	C Meas'mt Acc'cy, Range 4	42
.4	Resistance Meas'mt Accuracy	44
.5	Inductance Meas'mt Accuracy	45
.6	D Measurement Accuracy	47
.7	Limit Comparison Bins	49
5.9	RECALIBRATION	5-51
.1	Preparation	51
.2	Zeroing and Selecting	53
.3	Recalibration, Range 4	53
.4	Recalibration, Range 3	54

.5	Recalibration, Range 2	55	6-6.	Main Board, schematic sheet 2	6-10
.6	Recalibration, Range 1	56	6-7.	Main Board, schematic sheet 3	6-11
.7	Frequency Calibration	57	6-8.	Main Board, schematic sheet 4	6-12
.8	Frequency Correction K Factor	58	6-9.	Main Board, schematic sheet 5	6-13
5.10	INTERNAL SETTINGS . . . . .	5-60	6-10.	Main Board, schematic sheet 6	6-14
.1	Address for IEEE-488 Interface	60	6-11.	Main Board, schematic sheet 7	6-14
.2	Making +5 V Available (Handler)	61	6-12.	Power Supply, assembly . . . . .	6-15
			6-13.	Power Supply Board, layout . . .	6-16
			6-14.	Power Supply, schematic . . . .	6-16
			6-15.	Display Board, layout . . . . .	6-17
			6-16.	Display Board, schematic . . . .	6-18
			6-17.	H-S Interface Bd., layout, sh1	6-19
			6-18.	H-S Interface Bd., layout, sh2	6-19
			6-19.	H-S Interface, schematic 1, . .	6-20
			6-20.	H-S Interface, schematic 2, . .	6-21
			6-21.	H-S Interface, schematic 3, . .	6-22
			6-22.	Interface Board, layout, . . . .	6-23
			6-23.	Interface, schematic, . . . . .	6-24
			6-24.	Keyboard Module, assembly . . .	6-25
			6-25.	Keyboard Indicators, detail . .	6-25
			6-26.	Keyboard, schematic . . . . .	6-26
PARTS LISTS AND DIAGRAMS -- SECTION 6					
6.1	GENERAL . . . . .	6-1			
6.2	REFERENCE DESIGNATIONS . . . . .	6-1			
6.3	DIAGRAMS . . . . .	6-5			
6-1.	1689 Front, showing mech.parts	6-2			
6-1A.	1689M Front, showing mech.parts	6-4			
6-2.	1689 Rear, showing mech.parts	6-2			
6-2A.	1689M Rear, showing mech.parts	6-4			
	Federal Supply Code, Manufacturers	6-6			
6-3.	Main Board, schematic sheet 1	6-7			
6-4.	Main Board, layout sheet 1 . . .	6-8			
6-5.	Main Board, layout sheet 2 . . .	6-9			



---

# Specifications

---

## Displays

Measurement results may be displayed in four ways as selected by the keyboard: 1) VALUE, 2) % difference, 3) RLC difference, and 4) BIN NO.

- 1) The VALUE display can be one of four pairs of measured quantities L and Q, C and D, C and R, or R and Q. The primary display (L, C, or R) has five digits of resolution and the secondary display (D, Q, or R with C) has four digits of resolution.
- 2) The % difference display indicates the percent deviation of the measured L, C, or R value from a stored NOMINAL VALUE. The sign of this deviation is indicated.
- 3) The RLC difference is similar to the % difference except that the deviation is displayed in appropriate units (ohms, henries, etc.)
- 4) The BIN NO. display is the number of the bin (0 through 14) into which the component should be sorted. The testing limits for these bins are set up by the user in the ENTER mode. These test limits may be symmetrical or non-symmetrical about the NOMINAL VALUE. One bin is used for D or Q rejects and one is used for RLC rejects (outside all limits). The sum of the number of components sorted into each bin may be displayed (99999 max).

Also displayed during entry or upon interrogation are: test frequency, test voltage, number of measurements averaged, delay time, nominal value, bin limits and bin sum and codes for SPECIAL FUNCTIONS.

GO/NO-GO lights are also provided and these are active with all modes of measurement display as long as test limits have been set.

## Ranges

*Primary Display:*\*

C: .00001 pF to 99999 uF  
R: .000010 to 99999 kΩ  
L: .00001 nH to 99999 H

% difference (C, R, or L): .0001% to 99999%; RLC difference: same as R, L, or C.

If any of these quantities is negative, the NEG RLC indicator light is lit.

\*These ranges may be extended by a factor of more than 10,000 larger or smaller by using the special ratio mode.

*Secondary Display:*

D (with C) or Q (with L or R): .0001 to 9999

D (with C) or Q (with R) in ppm: 1 ppm to 9999 ppm

R (with C): .0001  $\Omega$  to 9999 k $\Omega$

If any of these quantities is negative, the NEG QDR indicator is lit.

### Equivalent Circuit

Either the equivalent SERIES or the equivalent PARALLEL circuit representation of L, R, or C may be selected by keyboard control.

### Test Frequencies

Over five hundred test frequencies between 12 Hz and 100 kHz may be selected using the keyboard. These are:

$$f = \frac{200\text{kHz}}{n} \text{ where } 2 \leq n \leq 13$$

$$f = \frac{60\text{kHz}}{n} \text{ where } 4 \leq n \leq 256$$

$$f = \frac{3\text{kHz}}{n} \text{ where } 13 \leq n \leq 250$$

If the exact frequency entered is not available, the nearest available frequency will be used. Frequency tolerance is .01%.

### Measurement Time

Measurement rate is selected via the keyboard. The time required for a complete measurement is typically less than indicated in Tables A and B..

TABLE A  
GR1689 MEASUREMENT RATE

MEASUREMENT RATE	TEST FREQUENCY					
	12 Hz	100 Hz	120Hz	1 kHz	10 kHz	100 kHz
SLOW	875 ms	940 ms	940 ms	970 ms	930 ms	930 ms
MEDIUM	670 ms	130 ms	185 ms	200 ms	190 ms	190 ms
FAST	670 ms	125 ms	110 ms	80 ms	75 ms	70 ms
MAXIMUM	670 ms	110 ms*	100 ms*	40 ms	34 ms	33 ms

- Notes: 1. If the high-speed option is *not* used, add 19 ms for MAXIMUM, or 38 ms for SLOW, NEDIUM or FAST measurement.  
 2. If the display is value, delta%, or *deltaRLC*, add 6 to 10 ms.  
 3. If data is output via the IEEE Bus., add 6 to 12 ms.  
 4. For ACQ, subtract 22 ms for SLOW, MEDIUM or FAST and 12 ms for MAXIMUM.

TABLE B  
GR1689M MEASUREMENT RATE

MEASUREMENT RATE	TEST FREQUENCY					
	12 Hz	100 Hz	120 Hz	1 kHz	10 kHz	100 kHz
SLOW	875 ms	920 ms	920 ms	950 ms	920 ms	920 ms
MEDIUM	670 ms	120 ms	170 ms	180 ms	170 ms	170 ms
FAST	670 ms	105 ms	90 ms	65 ms	55 ms	55 ms
MAXIMUM	660 ms	101 ms*	86 ms*	32 ms	22 ms	22 ms

- Notes: 1. If the high-speed option is *not* used, add 12 ms for MAXIMUM, or 24 ms for SLOW, MEDIUM or FAST measurement.  
 2. If the display is value, delta% or *deltaRLC*, add 3 to 5 ms.  
 3. If data is output via the IEEE Bus, add 3 to 6 ms.  
 4. For ACQ, subtract 11 ms for SLOW, MEDIUM or FAST and 6 ms for MAXIMUM.

\* These times can be shortened by 14 ms with reduced accuracy using the quick acquisition routine.

The measurement times are obtained with use of the high-speed measurement option, continuous measurement mode, bin number display/handler output, and without IEEE-Bus data output. For other conditions, refer to the table notes.

If the measurement mode is triggered, programmed delay (settling time), if any, should be added. Normal power up conditions included a programmed delay of 7/f to 12/f ms depending upon measurement rate. This delay can be programmed to zero or to any value up to 100 sec.

Test connections can be broken (handler indexing can begin) as soon as data acquisition is complete (ACQ line low on handler interface). See Note 4 in tables.

## Measurement Modes

Two test modes are available: CONTINUOUS and TRIGGERED.

The CONTINUOUS mode makes successive measurements continuously, updating the display after each measurement.

TRIGGERED measurements are initiated by the START button, or remotely from the IEEE bus or from the Handler Interface, and the measurement result is displayed until the next measurement is started.

## Average

The AVERAGE of any number of measurements from 1 to 255 may be made as desired in either of the two MEASURE MODES. In the TRIGGERED mode, the running average is displayed and the final value held until the START button is again depressed. In the CONTINUOUS mode, only the final value is displayed.

## Test Voltage

The RMS test voltage is selectable from 5 mV to 1.275 V in 5 mV steps. The accuracy is:  $(5\% + 2 \text{ mV}) (1 + .001 f^2)$  where  $f$  = frequency in kHz.

This voltage may be applied behind a source impedance (which depends on the range) in which case the selected voltage is the maximum that will be applied and the voltage will be less at the low impedance end of each range. The voltage may be applied also behind 25 ohms using the CONSTANT VOLTAGE function in which case the applied voltage will be constant except when low impedances are measured.

## Delay

A delay of from 1 to 99999 ms may be added to allow for settling of external switches and to permit a wider selection of measurement rates.

## DC Bias

An internal bias of 2 V may be applied to capacitors under test by means of the INT BIAS key.

An external bias of up to 60 VDC may be applied to capacitors under test using a panel switch. The applied current should be limited to 200 mA.

The instrument is protected from damage from charged capacitors with a stored energy up to 1 joule at 60 volts or less. Protection from higher voltages may be provided by external components.

## Zeroing

Open: A simple OPEN operation removes the effects of stray capacitance and conductance of the internal test fixture or any other test fixture or cable.

Short: A similar SHORT zeroing operation removes the effects of series resistance and inductance.

## DUT Connections

The 1689 has a built-in test fixture that will accept radial or axial components. The 1689M has BNC connectors for attachment to a wide variety of measurement accessories. Four terminal (Kelvin) connections are made to the device under test. The instrument ground is guard for three-terminal measurements.

## Keyboard Lock

A combination of keyboard entries makes the keyboard inactive.

## Special Functions

Several special features may be selected. These include:

Direct range setting

Range extension

Choice of integration time

Blanking of lesser digits

Signal Reversal to reduce hum pickup effects

Selection of the median value of three measurements

A routine that reduces transient delays when bias is applied

Automatic parameter selection

Quick acquisition routine

### IEEE-488 Bus/Handler Interface Card (1658-9620)

*IEEE-488 Bus* (J2 on rear panel with option)

All front panel functions are programmable from the bus. All RLC, DQ, and bin data are available as output to the bus. Output data format: ASCII or Binary.

The following functions, per IEEE-488, have been implemented:

AHI Acceptor Handshake (Listener)

SHI Source Handshake (Talker).

T5 Talker with normal and talk-only modes (for systems without a controller), switch selectable on rear panel.

L4 Listener.

SRI Service Request (to request service when measurement is complete and the instrument is not addressed to talk).

RL2 Remote/Local (no local lockout, no return-to-local switch).

PPO No parallel port 11.

OC1 Device clear.

DT1 Device Trigger (to start measurement).

CO No controller functions.

*Handler Connections* (JI rear panel with option)

1. Outputs, Active low: (Open collector drivers rated at 30 V max. Each will sink 16 mA at 0.4 V. External power and pull-up resistors required).

Bin 0 through bin 9 (10 lines) -Sorting outputs.

ACQ OVER (1 line)-indicates end of data acquisition. Component may be removed (see TEST TIME).

EOT (1 line)-indicates end of test. Bin No. is valid.

2. Input, Active low:

(0 V < VI < 0.4 V, + 2.5 V < Vh < + 5 V)

Start (1 line)-Initiates new measurement.

## High-Speed Measurement/Interface Option 1689-9820)

Same as above option but also with high-speed capability to increase measurement rate and five more sorting bins (15 lines, open collector drives rated at 15 V max. Each will sink 24 mA at 0.5 V). See Measurement Rate specification, above.

### Environment

Operating: 0 to 50 degrees C, 0 to 85% relative humidity.

Storage: -40 to 74degrees C.

When the high-speed option is used, the operating temperature range is 0 to 40 degrees C.

### Temperature Effects (typical)

R, L or C: +/- 5 ppm/degree C.

Q or D: +/- [2 ppm/degree C + (3 ppm/degree C) x (frequency in kHz)]

All specifications refer to 23degree C (calibration temperature).

### Power

90 to 125 V or 180 to 250 V AC, 50 to 60 Hz.

Voltage selected by rear panel switch; 50 watts maximum, 40 watts typical. When the high-speed option is used, the maximum power is 60 watts.

### Mechanical

DIMENSIONS (W x H x D):

1689 14.781 x 4.40 x 13.50 in. (375.4 x 111.8 x 342.9 mm) WEIGHT: 13 lbs. (5.9 kg.)

1689M 17.25 x 5.625 x 15.160 in. (438.15 x 142.87 x 385.06 mm) WEIGHT: 17 lbs. (7.71 kg.)

### Limit or Error (Accuracy)

Primary Readout C, R, or L

$$C: .01\% \left[ (1 + K_{cv}) \left( \text{or } \frac{C_x}{C_{max}} \text{ or } \frac{C_{min}}{C_x} \right) \right] (1 + |D|) (1 + K_s + K_{fv}) + .01\%$$

$$R: .01\% \left[ (1 + K_{cv}) \left( \text{or } \frac{R_x}{R_{max}} \text{ or } \frac{R_{min}}{R_x} \right) \right] (1 + |Q|) (1 + K_s + K_{fv}) + .01\%$$

$$L: .01\% \left[ (1 + K_{cv}) \left( \text{or } \frac{L_x}{L_{max}} \text{ or } \frac{L_{min}}{L_x} \right) \right] \left( 1 + \frac{1}{|Q|} \right) (1 + K_s + K_{fv}) + .01\%$$

**NOTES:**

1. The limit of error is a percent of the reading and may be positive or negative.
2. The largest term of the first bracketed factor should be used.
3. CX, RJC, and Lx are the values of the components being tested, and Cmax, Cmin, Rmax, etc., are range constants given in Table C.
4. The values of Ks, Kfv, and Kcv are all zero for measurements made at 1 kHz, with the SLOW measurement rate and using a non-CONSTANT 1 V signal. For other test conditions, these constants may be evaluated using Tables D through G.
5. These specifications assume proper OPEN and SHORT zeroing calibrations made at 1 kHz. Much better accuracy is possible at extreme impedance values if these zeroing calibrations are recent and made at the test frequency to be used. For example, the SLOW MEASUREMENT rate typically will give 1 % accuracy when measuring 100 Mohm at 30 Hz, 0.1F at 120 Hz, 0.1 pF at 10 kHz, or 0.1 uH at 100 kHz. Even better accuracy is possible if several measurements are averaged.
6. Although L measurements on the 1689 should be capable of the accuracy stated above, calibrations by the National Bureau of Standards are specified to .02%; this amount should be added to the 1689 specification for inductance measurements if they are to be used in any manner involving legal certification.

*Secondary Readout R with C*

*R (with C); D ≥ 1:*

$$1 \text{ count} + .01\% \left[ \left( 1 + K_{cv} \right) \text{ or } \frac{R_x}{R_{max}} \text{ or } \frac{R_{min}}{R_x} \right] \left( 1 + \frac{1}{|D|} \right) (1 + K_s + K_{fv}) + .01\%$$

*R (with C); D < 1:*

$$1 \text{ count} + .01\% \left[ \left( 1 + K_{cv} \right) \text{ or } \frac{C_x}{C_{max}} \text{ or } \frac{C_{min}}{C_x} \right] \left( 1 + \frac{1}{|D|} \right) (1 + K_s + K_{fv}) + .01\%$$

**NOTES:**

This is a percent of reading specification plus (or minus) 1 count because of resolution. Otherwise, the notes for the primary readout apply.

*Secondary Readout D, and Q*

*D (with C):*

$$.0001 \left[ \left( 1 + K_{cv} \right) \text{ or } \frac{C_x}{C_{max}} \text{ or } \frac{C_{min}}{C_x} \right] (1 + |D| + D^2) (1 + K_s + K_{fv}) + .0001$$

*Q (with R):*

$$.0001 \left[ \left( 1 + K_{cv} \right) \text{ or } \frac{R_x}{R_{max}} \text{ or } \frac{R_{min}}{R_x} \right] (1 + |Q| + Q^2) (1 + K_s + K_{fv}) + .0001$$

*Q (with L):*

$$.0001 \left[ \left( 1 + K_{cv} \right) \text{ or } \frac{L_x}{L_{max}} \text{ or } \frac{L_{min}}{L_x} \right] (1 + |Q| + Q^2) (1 + K_s + K_{fv}) + .0001$$

**NOTES:**

*This is not a percent error but rather the amount, positive or negative, by which the D or Q reading may be in error.*

*Otherwise, the notes for the primary readout apply. When using DQ in PPM, the final term of .0001 should be removed.*

**Table C  
Range Constants**

	AUTO	RANGE 1*	RANGE HELD		RANGE 4
	RANGE		RANGE 2	RANGE 3	
Cmax	25 uF/f	6400 pF/f	100 nF/f	1600 nF/f	25 uF/f
Cmin	400 pF/f**	400 pF/f	6.4 nF/f	100 nF/f	1.6 uF/f
Rmax	410 KΩ	410 KΩ	25.6 KΩ	1.6 KΩ	100Ω
Rmin	6.25Ω	25.6 KΩ	1.6 KΩ	0.1 KΩ	6.25Ω
Lmax	65 H/f**	65 H/f	4100 mH/f	256 mH/f	16 mH/f
Lmin	1 mH/f	4.1 H/f	256 mH/f	16 mH/f	1 mH/f

Where f = test frequency in kHz.

\* This range is not used above 20 kHz.

\*\* Above 20 kHz, Cmin = 6.4 nF/f and Lmax = 4100 mH/f.

**Table D  
Kcv as a Function of Voltage Mode (Constant Voltage)**

Voltage Mode	Non-Constant	Constant Voltage
Kcv	0	2

**Table E  
Ks as a Function of Measurement Rate**

Measurement Rate	Slow	Medium	Fast	Maximum*
Ks	0	3	10	23

\* Fast measurement with minimum integration time programmed.



**Table F**  
**Kfv as a Function of Frequency and RMS Voltage for Range 1**

Frequency Voltage	12to <30Hz	30to <100Hz	100to <250Hz	250to <1kHz	1kHz	>1to 3kHz	>3to 6kHz	>6to 10kHz	>10to 20kHz	>20to 50kHz	>50to 100kHz
1 to 1.26V	7	3	2	1	0	2	6	15	50		
0.25 to <1V	10	6	4	2	1	3	10	20	65	This range is not used above 20kHz.	
0.1 to <.25V	20	13	9	6	4	6	15	30	100		
0.03 to <.1V	70	50	35	25	15	17	25	60	*		
0.01 to <.03V	*	*	100	70	50	50	70	*	*		

\* Not specified

**Table G**  
**Kfv as a Function of Frequency and RMS Voltage for Range 2, 3, and 4**

Frequency Voltage	12to <30Hz	30to <100Hz	100to <250Hz	250to <1kHz	1kHz	>1to 3kHz	>3to 6kHz	>6to 10kHz	>10to 20kHz	>20to 50kHz	>50to 100kHz
1 to 1.26V	7	3	2	1	0	1	2	3	5	15	30
0.25 to <1V	9	5	3	2	1	2	3	5	6	18	35
0.1 to <.25	12	8	6	5	4	5	6	8	10	22	40
0.03 to <.1V	35	30	25	20	14	15	15	15	20	30	50
0.01 to <.03V	90	80	70	60	50	50	50	50	60	70	90

	Description	Catalog Number
For accessory lists, see paragraph 1.4.	1689 Precision RLC Digibridge®	1689-9700
	1689M Precision RLC Digibridge®	1689-9750
	IEEE/Handler Interface Option	1658-9620
	High-Speed Measurement and IEEE/Handler Option	1689-9620
	1689M Rack Mount Kit	1689-9611

---

# Warranty

---



QuadTech warrants that Products are free from defects in material and workmanship and, when properly used, will perform in accordance with QuadTech's applicable published specifications. If within one (1) year after original shipment it is found not to meet this standard, it will be repaired, or at the option of QuadTech, replaced at no charge when returned to a QuadTech service facility.

**Changes in the Product not approved by QuadTech shall void this warranty.**

**QuadTech shall not be liable for any indirect, special or consequential damages, even if notice has been given of the possibility of such damages.**

**This warranty is in lieu of all other warranties, expressed or implied, including, but not limited to any implied warranty or merchantability or fitness for a particular purpose.**

## SERVICE POLICY

QuadTech policy is to maintain product repair capability for a period of five (5) years after original shipment and to make this capability available at the then prevailing schedule of charges.

---

# Introduction – Section 1

---

1.1	PURPOSE . . . . .	1-1
1.2	GENERAL DESCRIPTION . . . . .	1-2
1.3	CONTROLS, INDICATORS, AND CONNECTORS . . . . .	1-3
1.4	ACCESSORIES . . . . .	1-10
	CONDENSED OPERATING INSTRUCTIONS . . . . .	1-14

## 1.1 PURPOSE

The two Digibridge(R) precision RLC testers, GR1689 and GR1689M, are microprocessor-controlled, automatic, programmable RLC measuring instruments that provide high accuracy, convenience, speed, and reliability at low cost. Limit comparison, binning, and internal bias are provided; both test frequency and voltage are selectable. With an interface option, each Digibridge tester can communicate with other equipment and respond to remote control.

The versatile, adaptable test fixture, lighted keyboard, and informative display panel make these Digibridge testers convenient to use. Measurement results are clearly shown with decimal points and units, which are automatically presented to assure correctness. Display resolution is 5 full digits for R, L, and C (4 full digits for D, Q, Rs with Cs, and Rp with Cs). Notice that Rs is also known as ESR (equivalent series resistance).

The basic accuracy is 0.02%. Long-term accuracy and reliability are assured by the measurement system, which makes these accurate analog measurements over many decades of impedance without any critical internal adjustments. Calibration to account for any change of test- fixture parameters is semiautomatic; the operator needs to provide only open-circuit and short-circuit conditions in the procedure. The Digibridge tester normally autoranges and automatically identifies the principal measurement parameter.

The test fixture, with a pair of plug-in adaptors, receives any common component part (axial-lead or radial-lead), so easily that insertion of the device under test (DUT) is a one-hand operation. True 4-terminal connections are made automatically. Extender cables are available for measurements at a moderate distance from the instrument. They are optional for the 1689 (which has a built-in test fixture, but requires extension typically for bulky components or parts in an automatic handler). They are necessary for the 1689M, which has no built-in test fixture.

Limit comparisons facilitate sorting into 13 GO and 2 NO-GO bins.

Programmable test conditions include:

**Test** frequencies from 12 Hz to 100 kHz

**Test** voltages from 5 mV to 1.275 V; bias (2 V)

**Delay** (before data acquisition) from zero to 99999 ms

**Measurement speeds** up to 45 per second (with 1689M) or 30 per second (with 1689)

**Multi-measurement** routines with automatic averaging and/or median taking of 2 to 765 measurements.

**Displays:** measured values, percentages, differences, ratios, *GO/NO-GO*, binning

**Automatic** output of value, bin number, bin summary and other results via IEEE-488 bus

Bias can be applied to capacitors being measured, either by programming the selection of an internal supply (2 V) or by sliding a switch to connect an external voltage source (up to 60 V).

A choice between two interface options provides full "talker/listener" and "talker only" capabilities consistent with the standard IEEE-488 bus. (Refer to the IEEE Standard 488-1978, Standard Digital Interface for Programmable Instrumentation. See paragraph 2.8, in Section 2.) A separate connector also interfaces with component handling and sorting equipment.

## **1.2 GENERAL DESCRIPTION**

### **1.2.1 Basic 1689 Digibridge**

Convenience is enhanced by the arrangement of test fixture and controls on the front ledge, with all controls for manual operation arranged on a lighted keyboard. Above and behind them, the display panel is inclined and recessed to enhance visibility of digital readouts and indicators. These indicators and those at the keyboard serve to inform and guide the operator in manipulating the simple controls, or to indicate that remote control is in effect.

The 1689 instrument stands on a table or bench top. The sturdy metal cabinet is durably finished, in keeping with the long-life circuitry inside. Glass-epoxy circuit boards interconnect and support high-quality components to assure years of dependable performance. Although intended for bench-top use, this model can be rack mounted, using a type of mount that slides forward for convenience.

Adaptability to any common ac power line is assured by the removable power cord and the convenient line-voltage switch. Safety is enhanced by the fused, isolating power transformer and the 3-wire connection.

### **1.2.2 Basic 1689M Digibridge**

The essential front-panel features of the 1689 are provided on the vertical front of the model 1689M. These include the keypad, display, and the power ON/OFF button. The set of four BNC connectors for connection to the test fixture is supplied on the front panel, but can be relocated to the rear if that is preferred. The display panel and keyboard indicators serve to inform and guide the operator in manipulating the simple controls, or to indicate that remote control is in effect.

The 1689M instrument also stands on a table or bench, where the bail provided under its front edge can be used to tilt it back for operator convenience. This model goes particularly well in a rack, with its vertical front panel and cable connection (from either front or rear) to a suitable test fixture. The sturdy metal cabinet is durably finished, in keeping with the long-life circuitry inside. Glass-epoxy circuit boards interconnect and support high-quality components to assure years of dependable performance.

Adaptability to any common ac power line is assured by the removable power cord and the convenient line-voltage switch. Safety is enhanced by the fused, isolating power transformer and the 3-wire connection.

### 1.2.3 Interface Options

Either of the two interface options adds I/O capabilities to the instrument, enabling it to control and respond to parts handling/sorting equipment. Also (via separate connector) either option can be connected in a measurement system using the IEEE-488 bus. Either "talker/listener" or "talker only" roles can be performed by the Digibridge, by switch selection.

One of the interface options enables the Digibridge to measure at a higher speed than it does without an option. The high-speed option provides outputs to 15 bins for sorting; the other option, to 10 bins.

### 1.2.4 References

Electrical and physical characteristics are listed in Specifications at the front of this manual. Interface connections and instrument dimensions are given in Installation, Section 2. Controls are described below in Section 1; their use, in Operation, Section 3. A functional description is given in Theory, Section 4.

## 1.3 CONTROLS, INDICATORS, AND CONNECTORS

Figure 1-2 shows the controls and indicators on the front of the 1689 instrument. Table 1-1 identifies them with descriptions and functions. Figure 1-1 shows the front of the 1689M model, which is functionally similar.

Similarly, Figure 1-3 shows the controls and connectors on the rear of the 1689; and Table 1-2 identifies them. Figure 1-4 shows the rear of the 1689M model, which is functionally similar.

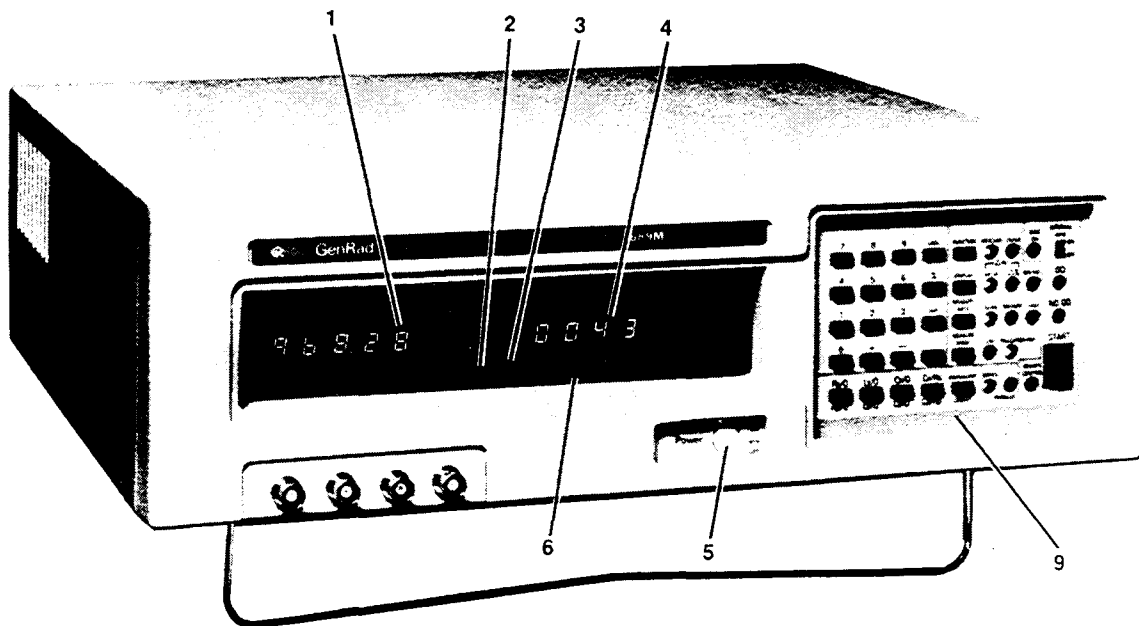

Figure 1-1. The 1689M RLC Digibridge tester, front view.

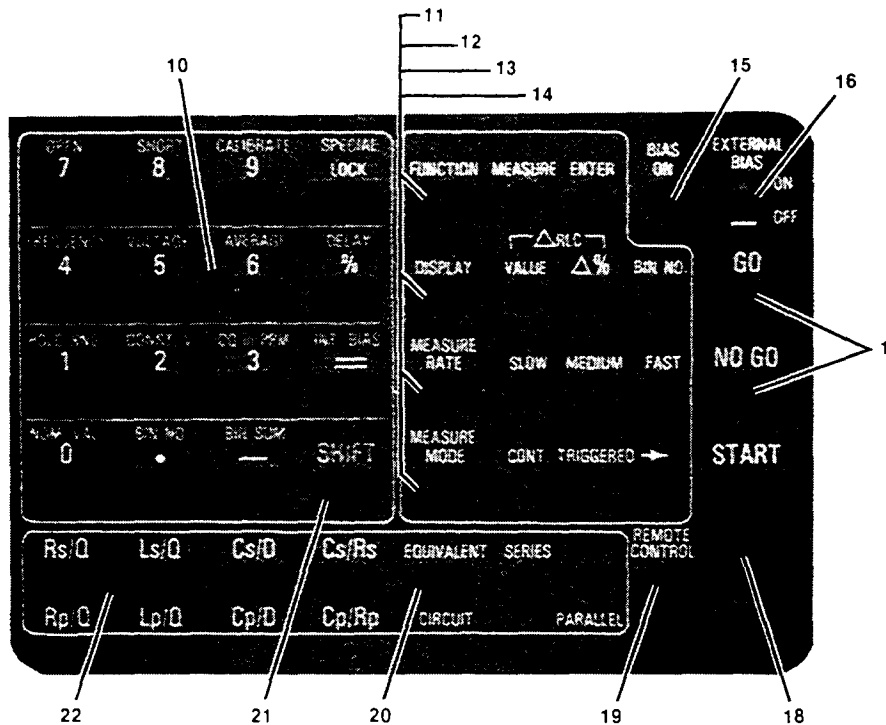
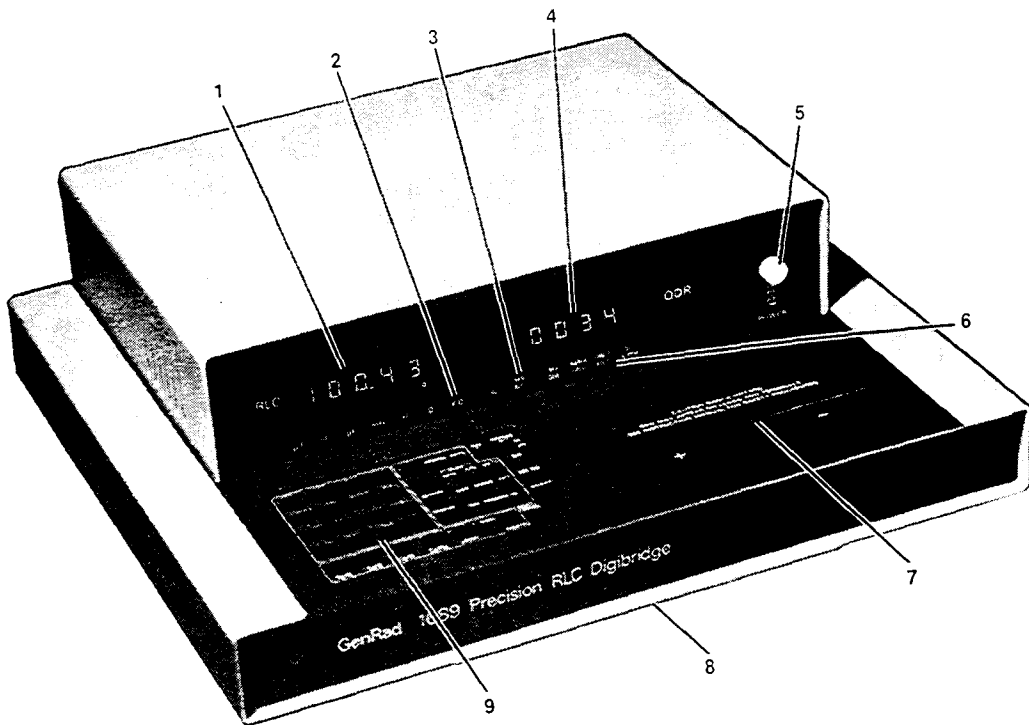

Figure 1-2. Front controls and displays. Upper illustration: 1689 Digibridge tester, overall. Lower illustration: keyboard detail.

Table 1-1  
Front Panel Controls and Indicators

Fig. 1-2

Ref No.	Name	Description	Function
1	RLC display	Digital display, 5 numerals with decimal points	Display of principal measured value. If function is MEASURE and display selection is VALUE, number indicates R, L, or C. If display selection is delta% or deltaRLC, indicates percentage difference (respectively) of R, L, or C compared to stored nominal value. If display selection is BIN NO., indicates bin assignment of measured DUT. If function is ENTER, displays are indications of programmed entries, special functions, bin sum, status in calibration sequences, etc.
2	Units and multipliers	Light-spot (LED) indicators	Indicates measurement units associated with RLC display and secondary display if it is R. Indicates "%" if display selection is delta%. None of these indicators are lit if measurement display is "ratio".
3	"NEG" indicators	Light-spot (LED) indicators	NEG RLC and Null Q/R indicate negative signs associated with RLC and Q/R displays. (For explanations see paragraph 3.3.)
4	Q/R display	Digital display, 4 numerals with decimal points	If function is MEASURE, display of secondary measured value or (if display is BIN NO.) blank. If function is ENTER, RLC and Q/R displays together indicate programmed entries, special functions, status in calibration sequences, etc.
5	POWER switch	Pushbutton (push again to release)	Switches the Digibridge ON (button in) and OFF (button out). OFF position breaks both sides of power circuit.
6	Other display-panel indicators	Light-spot (LED) indicators	RANGE HELD indicates that autoranging is disabled. CONST VOLT indicates that measurement source resistance is fixed at a low value. DQ, in PPM indicates that the D or Q display is in parts per million.
7	Test fixture	Pair of special connector; each makes dual contact [Not on 1689M]	Receives radial-lead DUT, making 4-terminal connection automatically. Adaptors (supplied) make similar connection with axial-lead DUT. Extension cables (5-terminal) are available.

Table 1-1 (continued)  
FRONT CONTROLS AND INDICATORS

Fig. 1-2

Ref No.	Name	Description	Function
8	Reference card	Captive pull-out card [Not on 1689M.]	Handy reference information for basic operation: zeroing, making measurements, programming test conditions, limit entry, and bin sorting.
9	Keyboard	Group of keys, indicators, and 2 other switches	Manual programming and control. Refer to items 10 through 22 for more detail,
10	Programming keys	Set of 16 keys, labeled white and yellow for 1689, black and gray for 1689M	Multipurpose input of programming instructions, selections, and data. Dual purposes of keys are indicated by color: White or black labels apply normally. Yellow or gray labels apply immediately after <i>you</i> press and release the [SHIFT] key,
11 thru 14, 20, and 22 (See below.)		Each key has associated <i>LED</i> indicators	Make selection by pressing key repeatedly until the desired condition is indicated at right of the key.
11	[FUNCTION] key	Indicators MEASURE and ENTER.	Selection of function. MEASURE enables measurements and some routines that cannot be done in ENTER, such as "zero" calibrations, keyboard lock or unlock, and part of full recalibration, ENTER enables programming of all special functions, frequency, voltage, averaging, delay, nominal value, and binning instructions, (Either function allows selection of hold range, constant voltage, DQ in ppm, internal bias, parameter, equivalent circuit, measure mode, measure rate, and display.)
12	[DISPLAY] key	Indicators: VALUE, delta%, BIN NO.	Selection of displays for MEASURE function; refer to items 1, 2, and 4 for description of displays. Two indicators are lit simultaneously for deltaRLC. This key has no effect on ENTER function displays
13	[MEASURE RATE] key	Indicators: SLOW, MED, FAST.	Selection of measurement speed as indicated. Speed is also affected by many other choices described in paragraph 3.5. Use SLOW for better accuracy use FAST for speed



Table 1-1 (continued)  
FRONT CONTROLS AND INDICATORS

Fig. 1-2

Ref No.	Name	Description	Function
14	[MEASURE MODE] key	Indicators: CONT, TRIGGERED	Mode selection: CONT, continuously repeating measurements; TRIGGERED, single measurement initiated by START button or input signal.
15	BIAS ON indicator	LED indicator	Indicates that internal bias is on, or the EXTERNAL BIAS switch is ON.
16	EXTERNAL BIAS switch	Slide switch, 2 positions: ON, OFF	To connect and disconnect the external bias circuit (rear connector, cable supplied).
17	GO/NO-GO indicators	Pair of LED indicators	GO means measured value is acceptable, based on the limits previously stored. (See paragraph 3.8.) NO-GO means RLC or QDR value or both are unacceptable. Indicator remains lighted during next measurement.
18	START button	Pushbutton switch.	Starts measurement sequence (aborting any measurement that may be in process). Normally used in TRIGGERED measure mode.
19	REMOTE CONTROL indicator	LED indicator	Indicates when remote control is established by external command. (Functions only if an interface option is installed.)
20	EQUIVALENT CIRCUIT key	Indicators: SERIES and PARALLEL	Selection of equivalent circuit. Measured principal R, L, C and secondary R values (not D or Q) depend on this selection.
21	SHIFT key	Key labeled SHIFT	Pressing this shifts the role of any key labeled with both white and yellow (or black and gray) F~ the white 1U yellow or black to gray. Do NOT hold the the [SHIFT] key down; press it first, then the other key.
22	Parameter keys	Set of 3 keys, labeled: R/Q, L/Q, C/D, and C/R, with subscripts sand P	Selection of principal measurement parameter --R, L, or C --and (for C only) secondary parameter D or R. Repeated pushing of any one parameter key changes range in sequence 1 234 1 ...and hence measurement units.

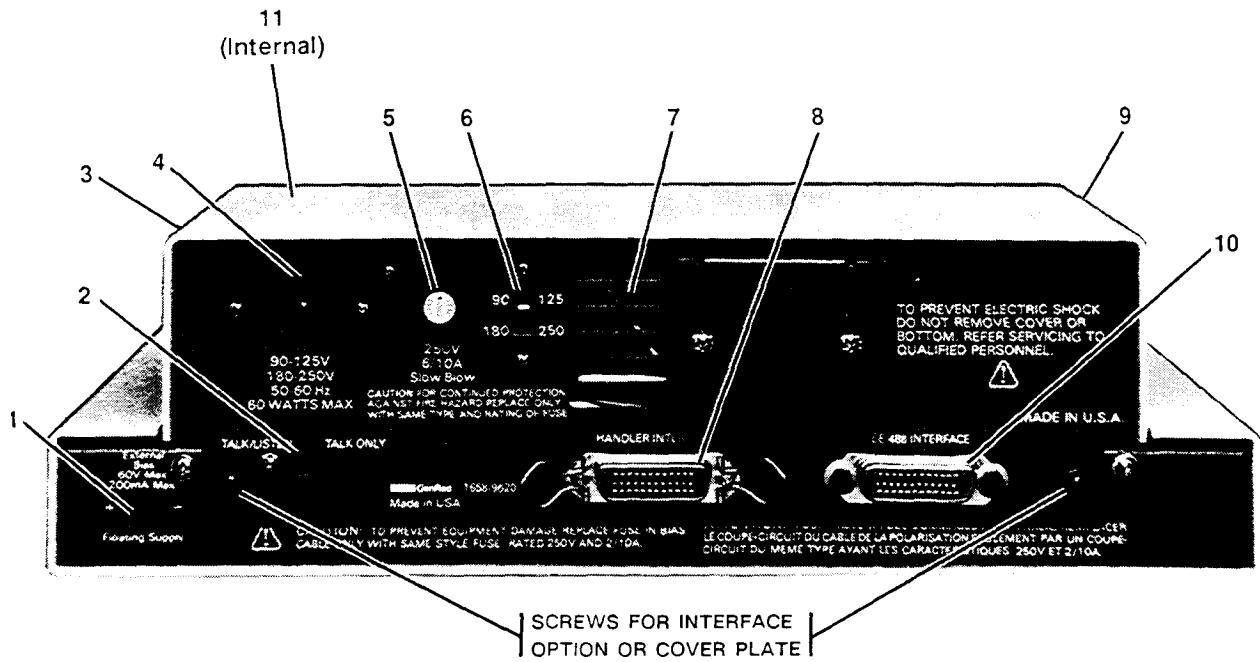

Figure 1-3. Rear controls and connectors, 1689 Digibridge.

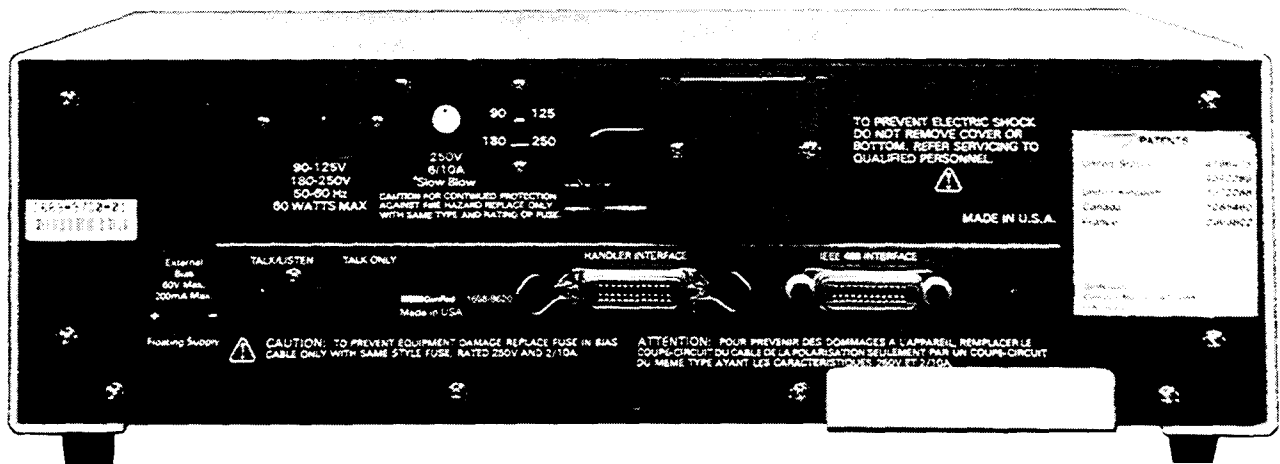

Figure 1-4. The 1689M Digibridge, rear view.

**Table 1-2**  
**REAR CONNECTORS AND CONTROLS**

**Fig. 1-3**

Ref No.	Name	Description	Function
1	EXTERNAL BIAS connector	Connector, 2 pins, labeled 60 V max, 200 mA max, + -.	Receives cable (1658-2450, supplied) for external bias supply. Observe the voltage and current limits and polarity.
2	TALK switch*	Toggle switch.	Selection of mode for IEEE-488 interface: TALK/LISTEN or TALK ONLY, as labeled.
3	Air filter	Porous plastic sponge	To prevent dirt from entering inlet vent.
4	Power connector labeled 90-125 V, 180-250 V, 50-60 Hz, etc.	Shrouded 3-wire plug, conCorming to International Electrotechnical Commission 320.	AC power input. Use appropriate power cord, with Belden SPH-386 socket or equivalent. The GenRad 4200-0300 power cord (supplied) is rated Cor 125 V.
5	Fuse (labeled 250 V, 1/2 A, SLOW BLOW)	Fuse in extraction post holder	Short circuit protection. Use Bussman type MDL or equivalent fuse, 1/2 A, 250 V rating.
6	Line-voltage switch	Slide switch. Upper position: 90 to 125 V; lower position, 180 to 250 V.	Adapts power supply to line-voltage ranges, as indicated. To operate, use a small screw driver, not a sharp object.
7	Vent	Air passage	Venti lation
8	HANDLER INTERFACE connector*	Socket, 24-pin; receives Amphenol "Microribbon" plug P/N 5i-30240 (or equiv).	Connections to component handler (outputs are bin numbers and status; input is a "start" signal).
9	Vent	Air passage	Ventilation
10	IEEE-488 INTERFACE connector*	Socket, 24-pin. Receives IEEE-488 interface cable. (See paragraph 2.8).	Input/output connections according to IEEE Std 488-1978. Functions: complete remote control. Output of selected resul ts, with or without controller.

**Table 1-2**  
**REAR CONNECTORS AND CONTROLS (continued)**

**Fig. 1-3**

Ref No.	Name	Description	Function
11 Fuse (1/4 A)	Plug-in type,subs -	miniature, quick-acting. Manufactesr Part No.273.250 by LITTLEFUSE, Inc., 800 E.Northwest Hwy, Des Plaines IL 60016	Protects instrument circuitry from damage by charged capacitors.

\* TALK switch and 24-pin connectors are supplied with the interface option only.

## 1.4 ACCESSORIES

GenRad makes several accessories that enhance the usefulness of each Digibridge. The axial-lead adaptors (provided) convert the test fixture to a configuration well suited for axial-lead components. A choice of extender cables facilitates making connection to a parts handler or to any DUT that does not readily fit the test fixture. Extender cables are available with your choice of banana plugs, BNC, or type 874 connectors. Each cable branches into 4 parts, for true 4-terminal connections (and guard) to the device being measured, without appreciable reduction in measurement accuracy. A remote test fixture is available to receive hand-inserted components at a distance from the Digibridge.

Other useful accessories are offered. Refer to Tables 1-3, 1-4 and inquire at the nearest Digibridge Technical Support Center. (Refer to the back of this manual.)

**NOTE**

The GenRad line of Digibridge test fixtures, adaptors, and other accessories does continue to be improved and expanded. Inquire periodically at your local GenRad sales office for the latest information.

**Table 1-3**  
**ACCESSORIES AND OPTIONS FOR 1689 DIGIBRIDGE**

Quantity	Description	Part Number
1 supplied	Power cord, 200 cm (6.5 ft) long, 3-wire, AWG No.18, with molded connector bodies. One end, with Belden SPH-386 socket, fits instrument. Other end conforms to ANSI standard C73.11-1966 (125 V max).	4200-0300
2 supplied	Test-fixture adaptors, for axial-lead parts. Replacements available: set of 4 adaptors	1657-5995
1 supplied	Bias cable, with built-in fuse, to connect external bias supply and switching circuit.	1658-2450
1 recommended	High-speed measurement and IEEE-488/handler interface option retrofit (plug-in).	1689-9620
OR		
1 recommended	IEEE-488/handler interface option retrofit (plug-in).	1658-9620
1 recommended	Tweezers, for handling and measuring chip components with terminals on opposite faces. BNC connectors; 127-cm (50-inch) cable. Use with adaptor 1689-9601.	1689-9603
1 recommended	Kelvin Clip Cable, (or measuring large, low impedance components. Use with adaptor 1689-9601.	1689-9606
1 recommended	Extender cable for connection to parts handler, large or remote DOT, custom test fixture, etc. Length 100 cm (40 in). One end fits test fixture of Digibridge; other end terminates in 5 stackable banana plugs.	1657-9600
1 recommended	Test-fixture adaptor, for BNC cable.	1689-9601
1 recommended	BNC cable assembly, 4 color coded cables with known "stray" parameters, 90 cm (36 in.) long.	1689-9602
1 recommended	Remote test fixture (like the fixture on the Digibridge, adaptable in many ways), with BNC connectors. (Use 1689-9601 adaptor and 1689-9602 cable.)	1689-9600

Table 1-3 (continued)  
ACCESSORIES AND OPTIONS FOR 1689 DIGIBRIDGE

Quantity	Description	Part Number
1 recommended	Remote test fixture (like the 1689-9600); also has START bar, GO/NO-GO lights, which function only if the Digibridge has an interface option. Use 1689-9601 adaptor and 1689-9602 cable (as well as the 1689-2400 cable, included with this fixture).	1689-9605
1 available	Extender cable for connection to standards, large or remote DUT, custom test fixture, dielectric measurement cell, etc. Length 30 cm (12 in). One end fits test fixture of Digibridge, other end terminates in four type 874 coaxial connectors.	1688-9600
1 available	Rack mount kit (slides forward for complete access).	1657-9000
1 recommended	Calibration kit, contains six Kelvin-connected references (four precision resistances, open, and short), that plug into the built-in or 1689-9600/9605 test fixture.	1689-9604
1 replacement	Battery (Note: shelf life, 10 years; life in instrument is 5 to 10 years. Refer to paragraph 3.13.)	8410-3480*

\*Use the following battery if available: Panasonic part number BR-2/3A-F1 (Matsushita Electric Corp. of America. 1 Panasonic Way. Secaucus. N.J. 07094).

Table 1-4  
ACCESSORIES AND OPTIONS FOR 1689M DIGIBRIDGE

Quantity	Description	Part Number
1 supplied	Power cord, 200 cm (6.5 ft) long, 3-wire, AWG No. 18, with molded connector bodies. One end, with Belden SPH-386 socket, fits instrument. Other end conforms to ANSI standard C73.11-1966 (125 V max).	4200-0300
1 supplied	Bias cable, with built-in fuse, to connect external bias supply and switching circuit.	1658-2450
1 supplied	BNC cable assembly, 4 color coded cables with known "stray" parameters, 90 cm (36 in.) long. (Supplied with BNC-to-banana-plug adaptors.)	1689-9602

**Table 1-4 (continued)**  
**ACCESSORIES AND OPTIONS FOR 1689M DIGIBRIDGE**

Quantity	Description	Part Number
1 recommended	Tweezers, for handling and measuring chip components with terminals on opposite faces. BNC connectors; 127 -cm (50 -inch) cable. (No adaptor needed.)	1689-9603
1 recommended	High-speed measurement and IEEE-488/handler interface option retrofit (plug-in).	1689-9620
OR		
1 recommended	IEEE-488/handler interface option retrofit (plug-in).	1658-9620
1 recommended	Rack mount kit. (Digibridge front panel is always accessible; the BNC connectors for cable to test fixture can be mounted on either front or rear panel.)	1689-9611
1 recommended	Remote test fixture (like the 1689-9600); also has START bar, GO/NO-GO lights, which function only if Digibridge has an interface option. Use cables 1689-9602 (supplied with 1689M) and 1689-2400 (included with this fixture).	1689-9605
1 available	Remote test fixture for radial-lead DUTs (like test fixture on 1689 Digibridge), with BNC connectors. Use 1689-9602 cable (supplied with 1689M). Use axial-lead adaptors (supplied) if appropriate. Accepts other accessories, like extender cables 1657-9600, 1688-9600. (See Table 1-3).	1689-9600
2 (supplied with fixture)	Test-fixture adaptors, for axial-lead parts. Replacements available: set of 4 adaptors.	1657-5995
1 recommended	Calibration kit, contains six Kelvin-connected references (four precision resistances, open, and short), that plug into the 1689-9605 or the 1689-9600 test fixture.	1689-9601
1 replacement	Battery (Refer to information in preceding table.)	8410-3480
1 recommended	Kelvin Clip Cable, for measuring large, low impedance components.	1689-9606

# Condensed Operating Instructions for GenRad 1689 Digibridge

## 1 GENERAL INFORMATION

The 1689 RLC Digibridge<sup>®</sup> is a microprocessor-controlled, automatic RLC meter. It measures impedance of the device under test (DUT) and displays its parameters: *R*, *L* or *C* and *D*, *Q*, or *R*. A front-panel keyboard is used to select and program measurement and test conditions. The test signal is programmable from 5 mV to 1.26 V and from 12 Hz to 100 kHz. (Default conditions are 1 V, 1 kHz.) Capacitors under test can be biased with 2 V (internal d.c.) or up to 60 V (external source). Consult the instruction manual for details about operation, accuracy, specifications, and service.

### 2 START-UP

- Set line-voltage switch (rear panel) to power-line voltage.
- If the Digibridge includes an optional IEEE-488 interface, set TALK switch (rear panel) to TALK ONLY (unless instructions are to be received through the IEEE-488 bus).
- Switch EXTERNAL BIAS OFF (front panel).
- Connect power cord to source of proper voltage.
- Press POWER button "in". Self-check codes will show briefly.
- Wait until keyboard lights indicate MEASURE, VALUE, SLOW, SERIES. If a fault is detected, measurements are blocked and an error code remains displayed. (See manual, paragraph 3.13.) If keyboard lights remain dark, keyboard is locked. To unlock it, see manual paragraph 3.9. To switch power off, press POWER button and release.

### 3 ZEROING

Before measurement, zero the Digibridge as follows:

- Open Circuit.* The MEASURE keyboard light should be lit. Press [MEASURE MODE] key to select TRIGGERED mode. If any test-fixture adaptors are to be used, install and position them for use. Be sure that test fixture is open circuited. Press keys: [Cs/D] [1] [6] [8] [9] [=] [SHIFT] [OPEN]. Keep hands and objects at least 10 cm (4 in.) from test fixture. Press START button. Wait for GO light.

- Short Circuit.* Short the fixture with a clean copper wire (AWG 18 to 30). Press [1] [6] [8] [9] [=] [SHIFT] [SHORT]. Press START button. Wait for GO light.

Note: For best accuracy, repeat this procedure every day and after any change of test-fixture adaptors.

### 4 MEASUREMENT

a. Verify or select measurement conditions as follows (indicated by keyboard lights); press the adjacent key to change a selection.

- Function: MEASURE ([FUNCTION] key)
- Display: VALUE ([DISPLAY] key)
- Measure rate: SLOW ([MEASURE RATE] key)
- Measure mode: TRIGGERED ([MEASURE MODE] key)
- Equivalent circuit: SERIES ([EQUIVALENT CIRCUIT] key)

- To measure *C* and *D* of a Capacitor (C Range .0001 pF to 99999  $\mu$ F, D range .0001 to 9999): Press [Cs/D]. Place capacitor in test fixture. Press START. The RLC display shows Cs (series capacitance) and units ( $\mu$ F, nF, pF); the QDR display shows D (dissipation factor). If "NEG RLC" is lit, DUT is inductive.)

- To measure *C* and *R* of a Capacitor (C range .00001 nF to 99999  $\mu$ F, R range .0001  $\Omega$  to 9999 k $\Omega$ ): Press [Cs/Rs]. Place capacitor in test fixture. Press START. The RLC display shows Cs (series capacitance and units ( $\mu$ F, nF); the QDR display shows Rs (equivalent series resistance and units ( $\Omega$ , k $\Omega$ )). If "NEG RLC" is lit, DUT is inductive.)

- To measure *L* and *Q* of an Inductor (L range .00001 mH to 99999 H, Q range .0001 to 9999): Press [Ls/Q]. Place inductor in test fixture. Press START. The RLC display shows Ls (series inductance) and units (mH, H); the QDR display shows Q (quality factor). If "NEG RLC" is lit, DUT is capacitive.)

- To measure *R* and *Q* of a Resistor (R range .00001  $\Omega$  to 99999 k $\Omega$ , Q range .0001 to 9999): Press [Rs/Q]. Place resistor in test fixture. Press START. The RLC display shows Rs (series resistance) and units ( $\Omega$ , k $\Omega$ ); the QDR display shows Q (quality factor). If "NEG QDR" is lit, DUT is capacitive; if dark, DUT is inductive.)

f. Special Displays. When a nominal value and bin limits have been programmed (see Limit Entry below), these displays can be selected with the [DISPLAY] key: " $\Delta$ " shows the difference of measured RLC from nominal in percent of nominal value. "VALUE and  $\Delta$ ", both lit, shows the difference from nominal in measurement units ( $\mu$ F, mH, etc). "BIN NO" shows the assigned bin number.

g. Other Parameters, Rates, Modes. To measure Cp/Rp, Cp/D, Lp/Q or Rp/Q, press [EQUIVALENT CIRCUIT] to select PARALLEL. To measure faster, press [MEASURE RATE] to select MEDIUM or FAST. To measure continuously, press [MEASURE MODE] to select CONT.

## 5 PROGRAMMABLE TEST CONDITIONS

(Accessible via ENTER function.)

- Press [FUNCTION] key to select ENTER function.
- Test frequency (normally 1 kHz) can be programmed from .012 kHz to 100 kHz. For 400 Hz, press [.] [4] [=] [SHIFT] [FREQUENCY].
- Test voltage (normally 1 V) can be programmed from .005 V to 1.26 V. For 15 mV, press [.] [0] [1] [5] [=] [SHIFT] [VOLTAGE].
- Averaging. Results can be averages of 2 to 255 measurements. To program averaging of 25 measurements, press [2] [5] [=] [SHIFT] [AVERAGE]. To cancel averaging, press [1] [=] [SHIFT] [AVERAGE].
- Delay. A delay of 1 to 99999 ms can be added to normal test time. For 238 ms, press [2] [3] [8] [=] [SHIFT] [DELAY].

Note: For steps b..e, to see present conditions, press [SHIFT] [FREQUENCY], [SHIFT] [VOLTAGE], [SHIFT] [AVERAGE], [SHIFT] [DELAY].

- For internal 2-volt dc bias for capacitors, press [SHIFT] [INT BIAS]. To remove internal bias, repeat [SHIFT] [INT BIAS].

- For D and Q displayed in parts per million, press [SHIFT] [DQ in PPM]. For decimal D Q displays, repeat [SHIFT] [DQ in PPM].

- To hold test voltage constant, press [SHIFT] [CONST V]. To cancel this selection, repeat [SHIFT] [CONST V].

- To hold a range: Measure a DUT in the range desired; or press one of the parameter keys ([Rs/Q] [Ls/Q] [Cs/D] [Cs/Rs]) repeatedly to step through the four ranges. When the desired range is indicated (by RLC unit indicator), press [SHIFT] [HOLD RNG]. To enable autoranging, repeat [SHIFT] [HOLD RNG].

Note: For steps f..i, conditions are indicated by lights.

## 6 LIMIT ENTRY, GO/NO-GO TESTING, AND SORTING INTO BINS

- Press [DISPLAY] key to select VALUE. Press [FUNCTION] key to select ENTER.

- To enter a single QDR limit (always bin 0): press parameter key (such as [Cs/D]) appropriate to DUT. To change range and unit multipliers, press same key repeatedly. Enter max limit of D or Rs Q with R; enter min limit of Rp or Q with L, as follows. (Keyed numbers appear on left-hand display.) Example, for Q limit of 85, press [8] [5] [=] [SHIFT] [BIN NO] [0] [0]. Value now moves to right-hand display, confirming storage of limit.

Note: If you make a mistake, press parameter key again and repeat the entry.

- To enter RLC limits for bins 1-13 three methods are given:

- Symmetrical percentage tolerances* (nested bins). Enter nominal value of DUTs to be sorted. (The value appears on the RLC display. Units were selected in step b.) Example, for nominal value 123.40, press [1] [2] [3] [.] [4] [=] [SHIFT] [NOM VAL]. Enter for bin 1 the narrowest percent tolerance to be sorted. Example, for a tolerance of  $\pm 0.2\%$ : press [.] [2] [%] [=] [SHIFT] [BIN NO] [0] [1]. The numerical limits for RLC are computed and rounded-off values displayed (upper limit at left, lower at right). For bin 2, enter the next wider tolerance, similarly; then bins 3, 4, 5, ... (always 2 digits for bin no.)

- Various nominal values* (bucket sort). Plan for non-overlapping bins, each with a nominal value and limits defined by percent tolerance. For bin 1, enter nominal value and tolerance as described above. For each successive bin, similarly enter a new nominal value, then the tolerance and bin number. (Changing the nominal value does not affect limits already stored. Any DUT that qualifies for 2 overlapping bins is assigned to the lower bin.)

- Unsymmetrical tolerances.* To enter unsymmetrical limits, for example +2% -5% in bin 6: press [2] [%] [-] [5] [%] [=] [SHIFT] [BIN NO] [0] [6]. Two percentages of the same sign can be entered. Always enter the more positive tolerance first.

- You can close any bin that has been opened (steps b, c). For RLC bins, follow this example for bin 8: press [0] [=] [SHIFT] [BIN NO] [0] [8]. To disable QDR sorting, close bin 0 thus: for D or Rs or Q with R, press [9] [9] [9] [=] [SHIFT] [BIN NO] [0] [0]; for Rp or Q with L, press [0] [=] [SHIFT] [BIN NO] [0] [0].

- To enable GO/NO-GO lights after opening at least one bin, leave "nominal value" at any non-zero value. To disable GO/NO-GO and all bin sorting, press [0] [=] [SHIFT] [NOM VAL].

Note: To see present numerical limits for bin 3 and nominal value, press [SHIFT] [BIN NO] [0] [3], and [SHIFT] [NOM VAL].

- To measure DUT with bin sorting: Press [FUNCTION] to select MEASURE, and [DISPLAY] to select BIN NO. Insert DUT. Press START. Observe GO/NO-GO and bin-number results. NO-GO indicates either QDR failure (bin 0) or RLC failure (bin 14). See manual, paragraph 3.8.



---

# Installation – Section 2

---

2.1 UNPACKING AND INSPECTION . . . . .	2-1
2.2 DIMENSIONS . . . . .	2-1
2.3 POWER-LINE CONNECTION . . . . .	2-2
2.4 LINE-VOLTAGE REGULATION . . . . .	2-3
2.5 TEST-FIXTURE CONNECTIONS . . . . .	2-3
2.6 BIAS VOLTAGE FOR THE DUT . . . . .	2-4
2.7 HANDLER INTERFACE (OPTION) . . . . .	2-5
2.8 IEEE-488 INTERFACE (OPTION) . . . . .	2-9
2.9 ENVIRONMENT . . . . .	2-15
2.10 RACK MOUNTING . . . . .	2-15

## 2.1 UNPACKING AND INSPECTION

If the shipping carton is damaged, ask that the carrier's agent be present when the instrument, is unpacked. Inspect the instrument for damage (scratches, dents, broken parts, etc.). If the instrument, is damaged **or** fails to meet specifications, notify the carrier and the nearest GenRad field office. (See list at back or this manual.) Retain the shipping carton and the padding material for the carrier's inspection.

## 2.2 DIMENSIONS

**Figure 2-1.**

The instrument is supplied in a bench configuration, i.e., in a cabinet with resilient feet for placement on a table. The overall dimensions are given in the figure. The two cabinet styles differ as follows

---

### **1689** (smaller)

---

### **1689M** (larger)

keypad horizontal, display tilted  
instrument does not tilt  
test fixture provided on front  
bench use primarily (rack possible)

keypad & display on front (vertical)  
instrument tilts for convenience  
test fixture always remote (BNC cables)  
multiple use (rack, shelf, bench...)

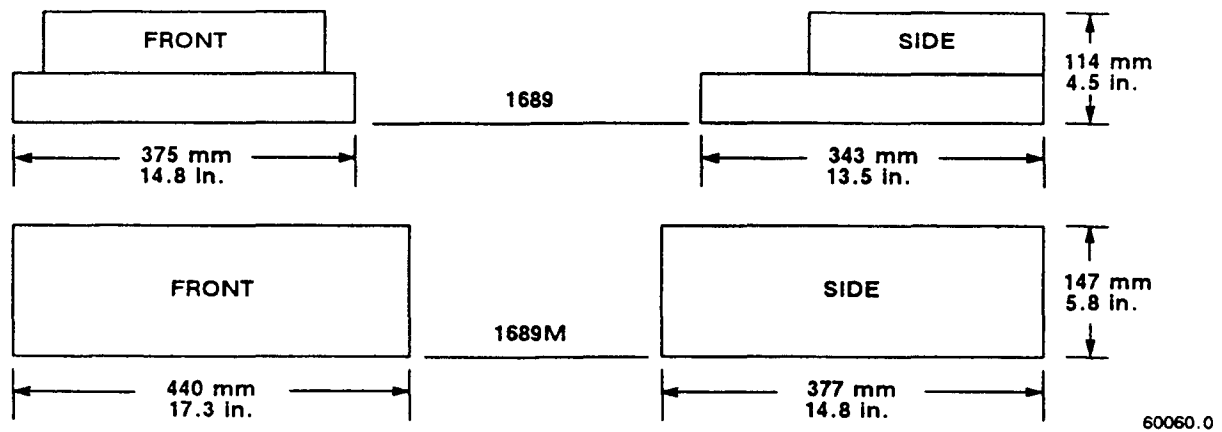

Figure 2-1. Overall dimensions of the Digibridge testers, 1689 and 1689M.

### 2.3 POWER-LINE CONNECTION

Figure 2-2.

The power transformer primary windings can be switched, by means of the line voltage switch on the rear panel, to accommodate ac line voltages in either of 2 ranges, as labeled, at a frequency of 50 or 60 Hz, nominal. Making sure that the power cord is disconnected, use a small screwdriver to set this switch to match the measured voltage of your power line.

If your line voltage is in the lower range, connect the 3-wire power cable (P IN 4200-0300) to the power connector on the rear panel (Figure 1-2) and then to the power line.

The instrument is fitted with a power connector that is in conformance with the International Electrotechnical Commission publication 320. The 3 flat contacts are surrounded by a cylindrical plastic shroud that reduces the possibility of electrical shock whenever the power cord is being unplugged from the instrument. In addition, the center ground pin is longer, which means that it mates first and disconnects last, for user protection. This panel connector is a standard 3-pin grounding-type receptacle, the design of which has been accepted world wide for electronic instrumentation. The connector is rated for 250 V at 6 A. The receptacle accepts power cords fitted with the Belden type SPH-386 connector.

The associated power cord for use with that receptacle, for line voltages up to 125 V, is GenRad part no. 4200-0300. It is a 200-cm (6.5 ft), 3-wire, 18-gage cable with connector bodies molded integrally with the jacket. The connector at the power-line end conforms to the "Standard for Grounding Type Attachment Plug Caps and Receptacles", ANSI C73.11-1966, which specifies limits of 125 V and 15 A. This power cord is listed by Underwriters Laboratories, Inc., for 125 V, 10 A.

If your power line voltage is in the higher range (up to 250 V), be sure to use a power cord that is approved for 250 V. The end that connects to the Digibridge8 tester should have a connector of the type that is on the power cord supplied; the other end, an approved connector to mate with your standard receptacle. A typical configuration for a 250- V, 15-A plug is illustrated in the accompanying figure.

If the fuse must be replaced, be sure to use a "slow blow" fuse of the current and voltage ratings shown on the rear panel, regardless of the line voltage.

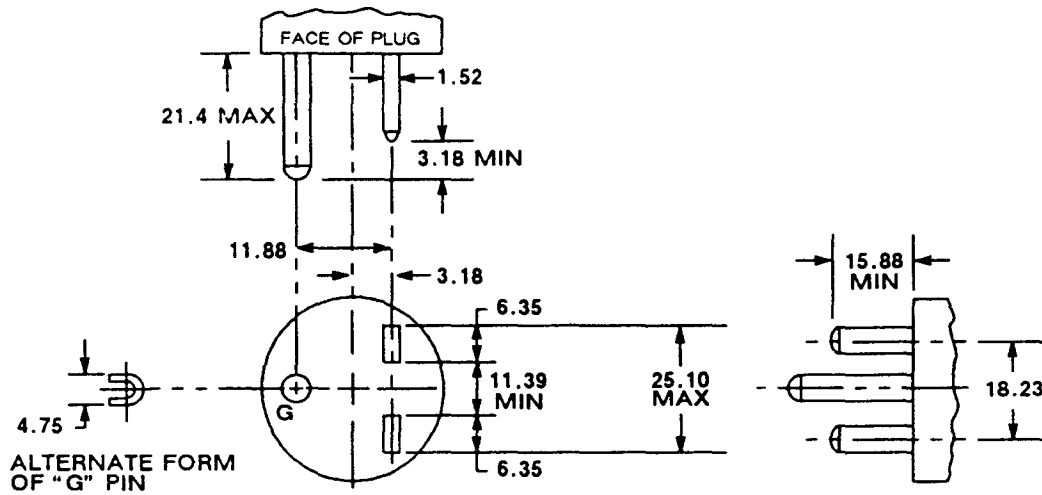

60029.0

Figure 2-2. Configuration of 250-V 15-A plug. Dimensions in mm. This is listed as NEMA 6-15P. Use for example Hubbell plug number 5666.

## 2.4 LINE- VOLTAGE REGULATION

The accuracy of measurements accomplished with precision electronic test equipment operated from ac line sources can often be seriously degraded by fluctuations in primary input power. Line-voltage variations of  $\pm 15\%$  are commonly encountered, even in laboratory environments. Although most modern electronic instruments incorporate some degree of regulation, possible power-source problems should be considered for every instrumentation setup. The use of line-voltage regulators between power lines and the test equipment is recommended as the only sure way to rule out the effects on measurement data of variations in line voltage.

## 2.5 TEST-FIXTURE CONNECTIONS

### 2.5.1 For the 1689 Digibridge

Because an unusually versatile test fixture is provided on the front shelf of the instrument, external test-fixture connections are generally NOT required. Simply plug the device to be measured (DUT) into the test fixture, with or without its adaptors. For details, refer to paragraph 3.2.

Accessory extender cables are available to connect to a DUT that is multiterminal, physically large, or otherwise unsuited for the built-in test fixture. Extender cables are needed, similarly, to connect from the Digibridge test fixture to the DUT socket in a mechanical parts handler. Cables and adaptors are listed in Table 1-3. Connection details are given in paragraph 3.2.

### NOTE

The GenRad line of Digibridge test fixtures, adaptors, and other accessories does continue to be improved and expanded. Inquire periodically at your local GenRad sales office for the latest information.

## 2.5.2 For the 1689M Digibridge

An external test fixture is always required, because connection from the 1689M Digibridge to the DUT is provided via BNC cables (from connectors that can be positioned at either front or rear of the instrument, as described in Section 5). For general purposes, the recommended test fixture, cable, and their connections are as follows. Refer to paragraphs 1.4 and 3.2 for more information about accessories.

On 1689M	Cable 1689-9602	On 1689-9605 Test Fixture
IL	black band	I+
PL	black & white	P+
PH	red & white	P-
IH	red band	I-

COMMENT: It is important that the n. and PL leads connect to the same end of the DUT (and that PH and IH connect to the other end). Also, *for the 1689 and 1689M Digibridges*, connecting IL/PL to the testfixture connectors labeled "+" (and IH/PH to "-") assures that the test fixture's "+" and "-" labels agree with the bias polarity.

NOTE: In the cable's color code, RED is associated with "hot" leads, which have dc voltage, negative with respect to ground, when bias is used.

## 2.6 BIAS VOLTAGE FOR THE DUT

### 2.6.1 Internal Bias

No external connections are required for the internal 2-volt bias. The circuit is self contained.

### 2.6.2 External Bias

External bias can be provided by connecting a suitable current-limited, floating dc voltage source, as follows.

**Be sure** that the voltage is never more than 60 V, max.

**A current** limiting voltage supply is recommended; set the limit at 200 mA, max.

**Be sure** that the bias supply is floating; DO NOT connect either lead to ground.

**A well filtered** supply is recommended. Bias-supply hum can affect some measurements, particularly if test frequency is the power frequency.

**Generally** the external circuit must include switching for both application of bias after each DUT is in the test fixture and discharge before it is removed.

**Connect** the external bias voltage supply and switching circuit, using the 1658-2450 cable, supplied, via the rear-panel EXTERNAL BIAS connector.

**Observe polarity** marking on the rear panel; connect the supply accordingly.

## 2.7 HANDLER INTERFACE (OPTIONAL)

### 2.7.1 Interface via High-Speed Measurement / Interface Option (1689-9620)

If you have the 1689-9620 High-Speed Measurement / IEEE-488 Bus / Handler Interface Option, connect from the HANDLER INTERFACE on the rear panel to a handler, printer, or other suitable peripheral equipment as follows. (The presence of the 24-pin connectors shown in Figure 1-3 verifies that you have one of the interface options; see also paragraph 2.7.2.) Refer to Table 1-2 for the appropriate connector to use in making a cable. Refer to Table 2-1 for the key to signal names, functions, and pin numbers.

Connect the bin control lines to the handler. See Table 2-1. Notice that the 1689-9620 High-Speed Measurement Option provides outputs for automatic sorting into 15 bins. (Refer to paragraph 3.8.)

As indicated in the Specifications at the front of this manual, the output signals come from opencollector drivers that pull each signal line to a low voltage when that signal is active and let it float when inactive. Each external circuit must be powered by a positive voltage, up to 15 V (max), with sufficient impedance (pull-up resistors) to limit the active-signal (logic low) current to 24 mA (max).

#### CAUTION

Provide protection from voltage spikes over 15 V.

The cautionary note above means typically that each relay or other inductive load requires a clamping diode (rectifier) across it (cathode connected to the power-supply end of the load).

The input signal is also active low and also requires a positive-voltage external circuit, which must pull the signal line down below 0.4 V, but not less than 0.0 V, i.e., not negative. The logic-low current is 0.4 mA (max). For the inactive state (logic high), the external circuit must pull the signal line above +2.5 V, but not above +5 V.

#### NOTE

The "end of test" signal EOT is provided by the Digibridge only while binning is enabled, by having a non-zero "nominal value" in memory. Refer to paragraph 3.8 for details.

Table 2-1  
HANDLER INTERFACE KEY

Signal Name	1689-* Pin No.	1658-* Pin No.	Function (All signals "active low")
DC CONNECTIONS:			
-----	5,6,7	5,6,7	Ground connection.
-----	10	10	DC bus (+5 V) available; see note**
INPUT:			
START	1	1	Initiates measurement (single or avg).
OUTPUTS:			
EOT	18	18	"End of test"; bin signals are valid.***
ACQ OVER	22	22	"Data acquisition over"; DUT removal OK.
BIN 0	15	15	No-go because of D or Q limit.
BIN 1	17	17	Go, bin 1.
BIN 2	19	19	Go, bin 2.
BIN 3	21	21	Go, bin 3.
BIN 4	23	23	Go, bin 4.
BIN 5	14	14	Go, bin 5.
BIN 6	16	16	Go, bin 6.
BIN 7	20	20	Go, bin 7.
BIN 8	24	-----	Go, bin 8.
BIN 9	2	-----	Go, bin 9.
BIN 10	3	-----	Go, bin 10.
BIN 11	4	-----	Go, bin 11.
BIN 12	8	-----	Go, bin 12.
BIN 13	9	-----	Go, bin 13.
BIN 14	13	-----	RLC fail, no-go by default (suits no other bin).
OTHER PASS-----	24		Go, eighth bin, for 1689 bins 8,9,10,11,12,13.
RLC FAIL -----	13		Ninth bin, no-go by default (1689 bin 14).

- \* Interface plug-in options: 1689-9620 (high-speed) and 1658-9620.  
 \*\* Low-power dc bus (+5 V) available for systems use, commonly for opto-couplers.  
 CAUTION: Limit the load to 25 mA, max.  
 \*\*\* EOT is enabled if binning is enabled (by having a non-zero nominal value).

### 2.7.2 Interface via IEEE-488 Bus / Handler Interface Option (1658-9620)

If you have the 1658-9620 interface option, connect from the HANDLER INTERFACE on the rear panel to a handler, printer, or other suitable peripheral equipment as follows. (The presence of the 24-pin connectors shown in Figure 1-3 verifies that you have one of the interface options; refer to paragraph 2.7.1 ) Refer to Table 1-2 for the appropriate connector to use in making a cable. Refer to Table 2-1 for the key to signal names, functions, and pin numbers.

Connect the bin control lines to the handler. See Table 2-1. Notice that the 1658-9620 IEEE-488 Bus / Handler Interface Option card provides outputs for automatic sorting into 10 bins. (Refer to paragraph 3.8.)

As indicated in the Specifications at the front of this manual, the output signals come from open collector drivers that pull each signal line to a low voltage when that signal is active and let it float when inactive. Each external circuit must be powered by a positive voltage, up to 30 V (max), with sufficient impedance (pull-up resistors) to limit the active-signal (logic low) current to 16 mA (max).

**CAUTION**

Provide protection from voltage spikes over 30 V.

The cautionary note above means typically that each relay or other inductive load requires a clamping diode (rectifier) across it (cathode connected to the power-supply end of the load).

The input signal is also active low and also requires a positive-voltage external circuit, which must pull the signal line down below 0.4 V, but not less than 0.0 V, i.e., not negative. The logic-low current is 0.4 mA (max). For the inactive state (logic high), the external circuit must pull the signal line above +2.5 V, but not above +5 v.

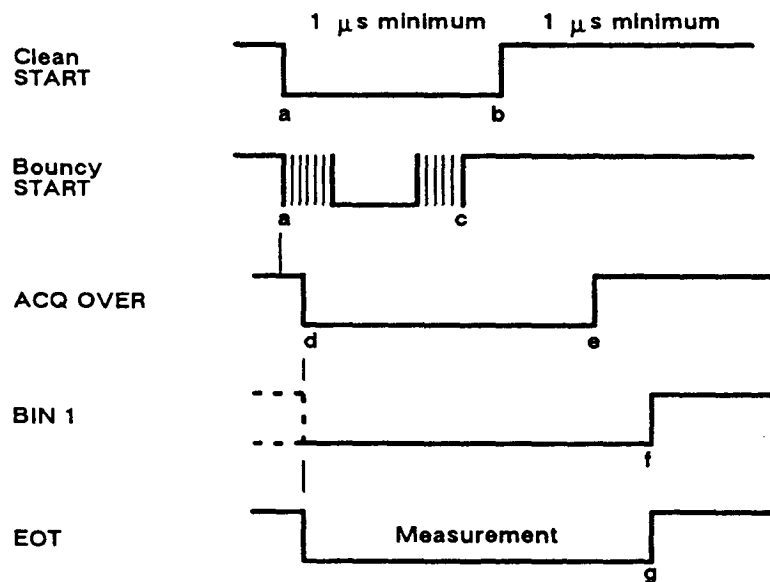

60045.0

Figure 2-3. Handler interface timing diagram. External circuit must keep a-b > 1 us, and (if START is not "debounced") a-c < [the settling time or programmed delay]. For single measurements, the DUT can be disconnected after e. The selected BIN line goes low at f; the other BIN lines stay high. For MEDIAN and/or AVERAGE measurement routines, ACQ OVER goes low (e) at the end of the last measurement.

**2.7.3 Timing**

**Figure 2-3.**

Refer to the accompanying figure for timing guidelines. Notice that START must have a duration of 1 us (minimum) in each state (high and low). If START is provided by a mechanical switch without debounce circuitry, the Digibridge will make many false starts; if START does not settle down (low) within the default settling time or the programmed delay time after the first transition to high, the measurement time may increase substantially. For an explanation of settling and delay time, refer to paragraph 3.5.3.

Measurement starts at time d, which is essentially the same as time b or c; measurement is completed at g. (The START signals are expanded for clarity.) Interval a-e, during which the DUT must remain connected for data acquisition, is considerably shorter than the total measurement time a-g. The DUT can be changed after e ("indexing on ACQ", to save time) or after g ("indexing on EOT", for a simpler test setup), as explained below.

After the calculation interval e-f, measurement results are available for sorting, i.e., one of the BIN lines goes low. A few micro-seconds later, EOT goes low (can be used to set a latch holding the bin assignment). ACQ OVER, the selected BIN line, and EOT then stay low until the next start command.

The time required for measurement depends on whether you have the high-speed measurement option, on test conditions, programmable values, and operating selections. Interval a-e can be less than 15 ms; the cycle time can be less than 40 ms; refer to paragraph 3.5 for details.

Set up the handler either of two ways: indexing on EOT or indexing on ACQ, as follows. The handler must supply a signal (here called "start next measurement") when it has completed connection of the DUT to the test fixture.

*Indexing on EOT*, Set up the handler to respond to the EOT signal from the Digibridge, which occurs at the "end of test", when the bin assignment is available for sorting. Set up the Digibridge to receive its START signal from the handler's "start next measurement" signal. This setup is simpler than the one below.

#### NOTE

The Digibridge requires that a non-zero value be entered for "nominal value" to enable generation of the EOT signal and indication by the GO/NO-GO lights; see paragraphs 3.8.3, 3.8.4.

*Indexing on ACQ*. Set up the handler to respond to the ACQ OVER signal from the Digibridge, which occurs when the "data acquisition" is complete. The handler can then remove the DUT from the test fixture and replace it with another DUT, while the Digibridge is calculating the result,

In addition, set up an interface that provides a START signal to the Digibridge by logical combination of the EOT signal from the Digibridge AND the "start next measurement" signal from the handler. Indexing on ACQ results in higher measurement rate than indexing on EOT.

Be sure the TALK switch is set to TALK ONLY, if the IEEE-488 bus is not used.



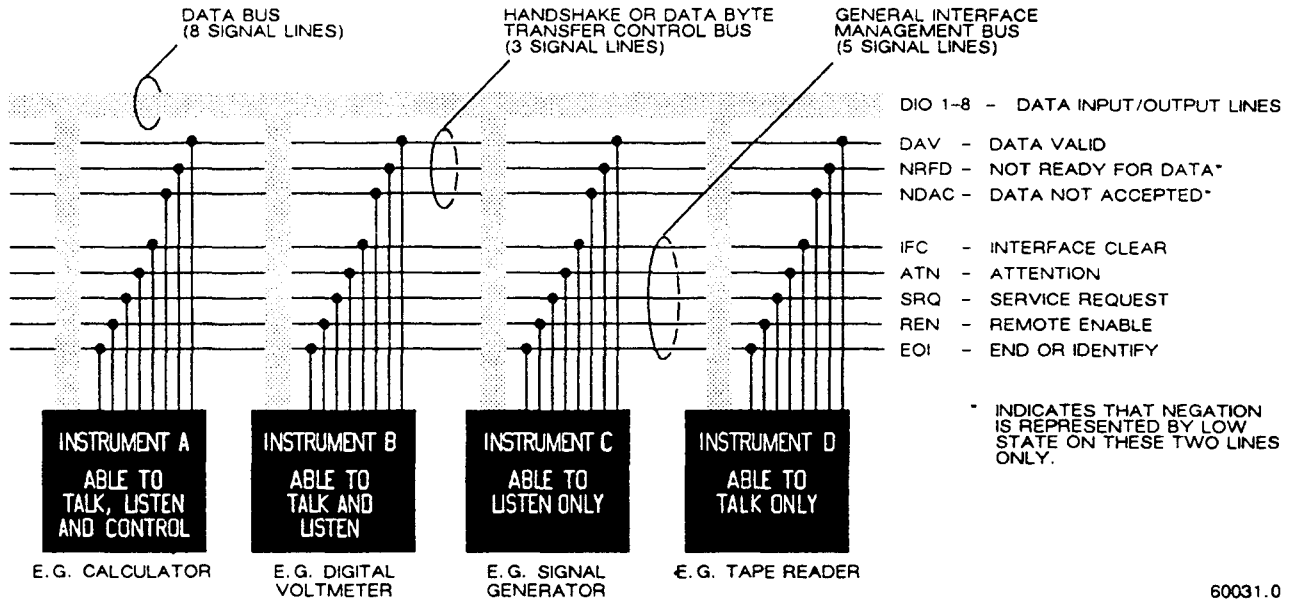

Figure 2-4. Block diagram of a generalized system interconnected by the 16-signal-line bus specified in the IEEE Standard 488. Reprinted from *Electronics*, November 14, 1974; copyright McGraw-Hill, Inc., 1974.

## 2.8 IEEE-488 INTERFACE (OPTION)

### 2.8.1 Purpose

Figure 2-4.

If you have either interface option, you can connect this instrument to a printer or into a system (containing a number of devices such as instruments, apparatus, peripheral devices, and generally a controller or computer) in which each component meets IEEE Standard 488-1978, Standard Digital Interface for Programmable Instrumentation. A complete understanding of this Standard (about 80 pages) is necessary to understand in detail the purposes of the signals at the IEEE-488 INTERFACE connector at the rear panel of this instrument.

#### NOTE

For copies of the Standard, order "IEEE Std 488-1978, IEEE Standard Digital Interface for Programmable Instrumentation", from IEEE Service Center, Department PB-8, 445 Hoes Lane, Piscataway, N. J. 08854.

To make connection to a single device like a printer, use a IEEE-488 cable, which fits the rear-panel connector labeled IEEE-488 INTERFACE. For larger systems, each device is connected to a system bus, in parallel, usually by the use of several stackable cables. Refer to the figure for a diagram of a hypothetical system. A full set of connections is 24 (16 signals plus shield and ground returns), as tabulated below and also in the Standard. Suitable cables, stackable at each end, are available from Component Manufacturing Service, Inc., West Bridgewater, MA 02379, U.S.A. (Their part number 2024/1 is for a I-meter-Long cable.)

This instrument will function as either a TALK/LISTEN or a TALK ONLY device in the system, depending on the position of the TALK switch. "TALK/LISTEN" denotes full programmability and is suited for use in a system that has a controller or computer to manage the data flow. The "handshake" routine assures that the active talker proceeds slowly enough for the slowest listener that is active, but is not limited by any inactive (unaddressed) listener. TALK ONLY is suited to a simpler system -e.g. Digibridge and printer --with 110 controller and no other talker. Either mode provides measurement results to the active listeners in the system.

## 2.8.2 Interface Functions

### Figure 2-5.

The following functions are implemented. Refer to the Standard for an explanation of the function subsets, represented by the identifications below. For example, T5 represents the most complete set of talker capabilities, whereas PPO means the absence of a capability.

- SHI, source handshake (talker)
- AHI, acceptor handshake (listener)
- T5, talker (full capability, serial poll)
- L4, listener (but not listen-only)
- SRI, request by device for service from controller
- RL2, remote control (no local lockout, no return-to-local switch)
- PP0, no parallel poll
- DC1, device clear
- DT1, device trigger (typically starts measurement)
- C0, no controller functions.

The handshake cycle is the process whereby digital signals effect the transfer of each data byte by means of status and control signals. The cycle assures, for example, that the data byte has settled and all listeners are ready before the talker signals "data valid". Similarly, it assures that all listeners have accepted the byte before the talker signals "data not valid" and makes the transition to another byte. Three signal lines are involved, in addition to the 8 that convey the byte itself. Refer to the accompanying figure.

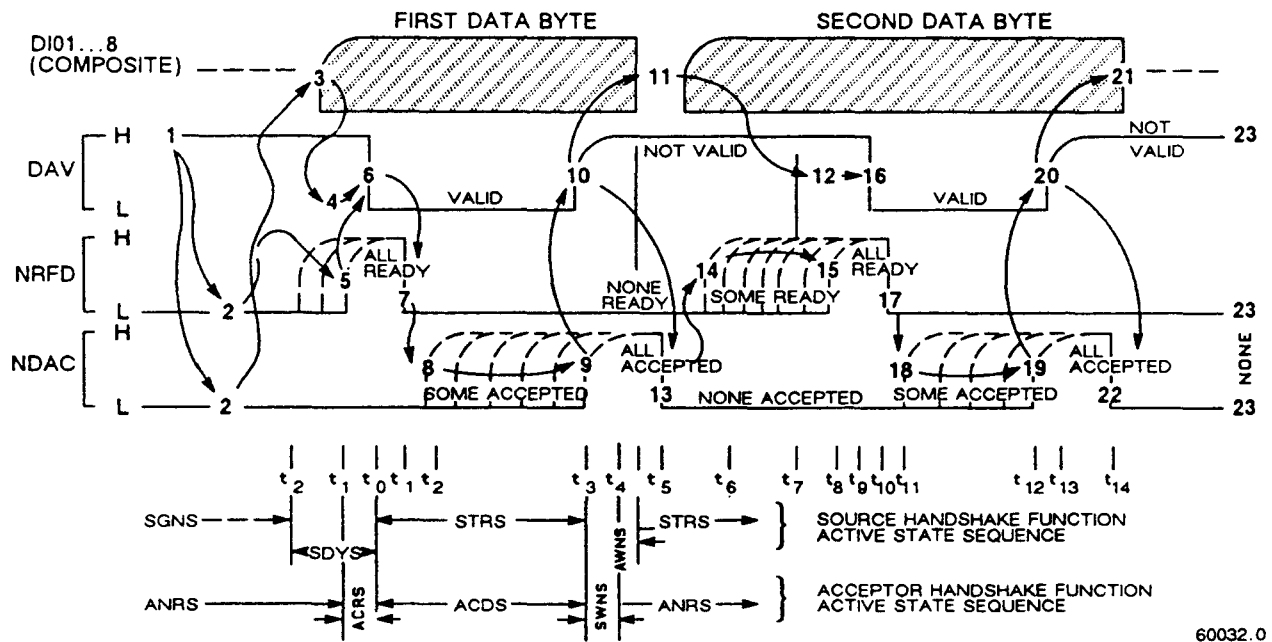

60032.0

Figure 2-5. The handshake process, illustrated by timing diagrams of the pertinent signals for a system with one talker and several listeners. For details, refer to the standard.

### 2.8.3 Signal Identification

Refer to Table 2-2 for a key to signal names, functions, and pin numbers. Further explanation is found in the Standard. The first three signals listed take part in the "handshake" routine, used for any multiline message via the data bus; the next five are used to manage the flow of information; the last eight constitute the multiline message data bus.

Table 2-2  
IEEE-488 INTERFACE KEY

Pin No.	Signal Name	Function or Significance
6	DAV	Low state: "data is available" and valid on the DI01...DI08 lines.
7	NRFD	Low state: at least 1 listener on the bus is "not ready for data."
8	NDAC	Low state: at least 1 listener on the bus is "not done accepting data."
11	ATN	"Attention", specifies 1 of 2 uses for the DI01...DI08 lines, as follows. Low state: controller command messages. High state: data bytes from the talker device.
9	IFC	"Interface clear." Low state: returns portions of interface system to a known quiescent state.
10	SRQ	"Service request." Low: a talker or listener signals (to the controller) need for attention in the midst of the current sequence of events.
17	REN	"Remote enable." Low state: enables each device to enter remote mode when addressed to listen; (Remote-control commands are conveyed while ATN is high.) High state: all devices revert to local control.
5	EOI	"End or Identify." "END" if ATN is in high state, then, low state of EOI indicates end of a multiple-byte data transfer sequence.* "IDY" if ATN is in low state; then, low state of EOI activates a parallel poll.**
1	DI01	The 8-line data bus, which conveys interface messages (ATN low state) or device-dependent messages (ATN high state), such as remote-control commands from the controller or from a talker device.
2	DI02	
3	DI03	
4	DI04	
13	DI05	
14	DI06	
15	DI07	
16	DI08	

-----  
\* "END" is typically sent concurrently with the delimiter "linefeed" character that terminates the string(s) of data output from the Digibridge (1, 2, or 3 lines; see para 2.8.4).

\*\* IDY is not implemented in this Digibridge.

## 2.8.4 Codes and Addresses

*General.* The device-dependent messages, such as instrument programming commands and measurement data (which the digital interface exists to facilitate), have to be coded in a way that is compatible between talkers and listeners. They have to use the same language. Addresses have to be assigned, except in the case of a single "talker only" with one or more "listeners" always listening. The Standard sets ground rules for these codes and addresses.

In this instrument, codes for input and output data have been chosen in accordance with the rules. The address (for both talker and listener functions) is user selectable, as explained below.

*Instrument Program Commands.* The set of commands used in remote programming is an input data code to which the instrument will respond as a "talker/listener", after being set to a remote code and addressed to listen to device-dependent command strings. The set includes all of the keyboard functions except switching

external bias ON/OFF and full recalibration, which are not remotely programmable.

Refer to paragraph 3.12.3 for a table of the commands used in programming.

*Address.* The initial setting of address, provided by the factory, is binary 00011. Consequently, the talk-address command (MTA) is C in ASCII code and, similarly, the listen-address command (MLA) is #. If a different address pair is desired, set it manually using the following procedure.

### WARNING

Because of shock hazard and presence of electronic devices subject to damage by static electricity (conveyed by hands or tools), disassembly is strictly a "service" procedure.

a. Take the Digibridge to a qualified electronic technician who has the necessary equipment for minor disassembly and adjustment. Have the electronic technician remove the interface option assembly, as described in the 1689 Digibridge Service instructions. (There is no need to remove the top cover first.)

b. Set the switches in "DIP" switch assembly S2 to the desired address, which is a 5-bit binary number. (See below.)

c. Replace the interface option assembly in its former place.

Notice that S2 is located at the end of the interface option board, about 3 cm (1 in.) from the TALK switch SI. If S2 is covered, lift the cover off, exposing the "DIP" switch, which has 6 tiny switches, numbered 1 thru 6. To enter logical 1's, depress the side of each switch nearest the end of the board (switch open). To enter logical 0's, depress the other side of the switch (switch closed). The address is read from 5 to 1 (not using 6). Thus, for example, to set up the address 00011, enter 0's at positions 5,4,3; enter 1's at positions 2, 1. (This makes the talk address "C" and the listen address "#".) Strictly speaking, the address includes more; S2 determines only the device-dependent bits of the address. You cannot choose talk and listen addresses separately, only as a pair. The list of possible pairs is shown in Table 2-3.

Table 2-3  
ADDRESS PAIRS AND SETTINGS FOR SWITCH S2

Talk address		Listen address		Switch setting*
Symbol	Binary	Symbol	Binary	5 4 3 2 1
@	1 000 000	(space)	0 100 000	0 0 0 0 0
A	1 000 001	!	0 100 001	0 0 0 0 1
B	1 000 010	"	0 100 010	0 0 0 1 0
C	1 000 011	#	0 100 011	0 0 0 1 1
D	1 000 100	\$	0 100 100	0 0 1 0 0
E	1 000 101	%	0 100 101	0 0 1 0 1
F	1 000 110	&	0 100 110	0 0 1 1 0
G	1 000 111	'	0 100 111	0 0 1 1 1
H	1 001 000	(	0 101 000	0 1 0 0 0
I	1 001 001	)	1 101 001	0 1 0 0 1
J	1 001 010	*	0 101 010	0 1 0 1 0
K	1 001 011	+	0 101 011	0 1 0 1 1
L	1 001 100	,	0 101 100	0 1 1 0 0
M	1 001 101	-	0 101 101	0 1 1 0 1
N	1 001 110	.	0 101 110	0 1 1 1 0
O	1 001 111	/	0 101 111	0 1 1 1 1
P	1 010 000	0	0 110 000	1 0 0 0 0
Q	1 010 001	1	0 110 001	1 0 0 0 1
R	1 010 010	2	0 110 010	1 0 0 1 0
S	1 010 011	3	0 110 011	1 0 0 1 1
T	1 010 100	4	0 110 100	1 0 1 0 0
U	1 010 101	5	0 110 101	1 0 1 0 1
V	1 010 110	6	0 110 110	1 0 1 1 0
W	1 010 111	7	0 110 111	1 0 1 1 1
X	1 011 000	8	0 111 000	1 1 0 0 0
Y	1 011 001	9	0 111 001	1 1 0 0 1
Z	1 011 010	:	0 111 010	1 1 0 1 0
[	1 011 011	;	0 111 011	1 1 0 1 1
\	1 011 100	<	0 111 100	1 1 1 0 0
]	1 011 101	=	0 111 101	1 1 1 0 1
^	1 011 110	>	0 111 110	1 1 1 1 0

\* Do Not set the switch to 11111, because a talk address of "-" would be confused with an "untalk" command, and a Listen address of "?" with an "unlisten" command. (ASCII code for "-" is 1 011 111 and for "?" is 0 111 111.)

In the above example, the remote message codes MLA and MTA are X0100011 and X100001 J , respectively. Thus the listen address and the talk address are distinguished, although they contain the same set of device-dependent bits, which you set into S2.

*Data Output.* Data (results of measurements) are provided on the DIO1...DIO7 lines as serial strings of characters. Each character is a byte, coded according to the 7-bit ASCII code, as explained above. The alphanumeric characters used are appropriate to the data, for convenience in reading printouts. The character strings are always provided in the same sequence as that tabulated in paragraph 3.12.3; for example: RLC value, QDR value, bin number --if all 3 were selected (by the X7 command). The carriage-return and line-feed characters at the end of each string provide a printer (for example) with the basic commands to print each string on a separate line.

For example, if the measurement was 0.54321 uF (1 kHz, range 4 held), the character string for RLC value is:

U(space)C(space)uF(2 spaces)0.54321(CR)(LF).

If the D measurement was .001, the character string for QDR value is:

(2 spaces)D(5 spaces)00.0010(CR)(LF).

If the measurement falls into bin 9, the character string for bin number is:

F(space)BIN(2 spaces)9(CR)(LF).

The character string for RLC value has the length of 17 characters; for QDR value, 17 characters; for bin number, 10 characters -including spaces, carriage-return, and line-feed characters. Refer to the format tables in paragraph 3.12.2 for details.

## 2.9 ENVIRONMENT

The Digibridge can be operated in nearly any environment that is comfortable for the operator. Keep the instrument and all connections to the parts under test away from electromagnetic fields that may interfere with measurements.

Refer to the Specifications at the front of this manual for temperature and humidity tolerances. To safeguard the instrument during storage or shipment, use protective packaging. Service personnel refer to Section 5.

When the Digibridge is mounted in a rack or other enclosed location, make sure that the ambient temperature inside the rack does not exceed the limits specified under "Environment" in the Specifications at the front of this manual, and that air can circulate freely past all air inlet and outlet vents.

## 2.10 RACK MOUNTING

**1689-9611, For 1689M Digibridge.** The 1689M Digibridge is more readily mounted in a rack than the 1689. Use this procedure.

a. If the location of the four BNC connectors (for test-fixture cables) is satisfactory, go on to the next step. Otherwise, the BNC connector location can be moved from front to rear (or vice versa); this is a SERVICE procedure, described in Section 5.5.

b. Preassemble the instrument with the shelf of the 1689-9611 Rack Mount Kit, as follows. Place the instrument on the shelf so that its feet drop through the large holes. Lift the shelf up snugly under the instrument and secure them together with a No. 10-32 screw through the small hole centered at the rear of the shelf, into the corresponding tapped hole in the instrument's rear panel.

#### NOTE

This screw is important for electrical grounding, as well as for mechanical security.

c. position this assembly in the rack as desired and fasten the shelf at the front of the rack, using the four dress screws, supplied. If the rack's mounting holes are tapped with number 10-32 threads, the nuts supplied for these screws can be omitted.

**1657-9000, For 1689 Digibridge.** The 1689 Digibridge can be mounted in a rack, using hardware that permits sliding the instrument forward for access. Use this procedure.

a. Obtain the 1657-9000 Slide Rack Mounting Kit, which includes the 1657-3100 sliding shelf assembly, instructions, and hardware.

b. Mount the shelf and slides in the rack, using the screws provided. Fasten the assembly at the front and rear of the rack. Slide the shelf forward for access.

c. Remove the four screws from the bottom of the Digibridge and slide the instrument out of its bottom shell.

d. Remove the four rubber feet from the bottom shell.

e. Place the bottom shell on the slide rack shelf and align it so that four small holes in the shelf appear centered through the four large holes in the shell. Fasten the shell to the shelf through these four holes using 10-32 screws, provided, as follows. Place a large washer under the head of each screw, which is then run through the hole in the shelf; place lock washer and nut on the end of the screw and tighten.

f. Slide the instrument into its bottom shell and reinstall the four screws removed in step c. (Large clearance holes are provided in the shelf for access.) This completes the installation.



---

# Operation – Section 3

---

3.1	BASIC PROCEDURE . . . . .	3-1
3.2	CONNECTING THE DUT . . . . .	3-4
3.3	MEASUREMENT PARAMETERS, RESULTS DISPLAYS, OUTPUTS . . . . .	3-13
3.4	PRINCIPAL TEST CONDITIONS . . . . .	3-23
3.5	MEASUREMENT TIME AND MEASUREMENT RANGES . . . . .	3-26
3.6	ACCURACY . . . . .	3-36
3.7	BIAS FOR THE DUT . . . . .	3-45
3.8	BIN SORTING AND GO/NO-GO RESULTS . . . . .	3-49
3.9	KEYBOARD LOCK, FUNCTION MAP AND INTERROGATIONS . . . . .	3-58
3.10	SPECIAL FUNCTIONS . . . . .	3-60
3.11	OPERATION WITH A HANDLER . . . . .	3-63
3.12	DATA OUTPUT AND/OR PROGRAMMING VIA IEEE-488 BUS . . . . .	3-64
3.13	SELF CHECKS AND FAILURE DISPLAYS (ERROR CODES) . . . . .	3-81
3.14	SAMPLE IEEE PROGRAMS . . . . .	3-83

## 3.1 BASIC PROCEDURE

### 3.1.1 General

For initial familiarization with the Digibridge(R) RLC tester, follow this procedure carefully. After that, use this paragraph as a ready reference and refer to later paragraphs in this section for details. Condensed operating instructions are provided in Section 1.

Users of the 1689 Digibridge (not the 1689M), refer also to the Condensed Operating Instructions, found stored in a pocket under the instrument. Reach under the front edge and pull the card forward as far as it slides easily. After use, slide it back in the pocket for protection.

### 3.1.2 Startup

#### CAUTION

Set the line voltage switch properly (rear panel) before connecting the power cord.

This is the regular startup procedure.

a. After the line-voltage switch has been set to the position that corresponds to your power-line voltage (which must be in either range: 90 to 125 V or 180 to 250 V ac, nominally 50 or 60 Hz), then connect the power cord as explained below.

*Temperature.* If the Digibridge tester has been very cold, warm it up in a dry environment, allowing time for the interior to reach 0 degrees C or above, before applying power. Otherwise, the instrument may be damaged by thermal shock

*Power Cord.* Connect the power cord to the rear-panel connector, and then to your power receptacle.

b. If the Digibridge tester includes an optional IEEE-488 interface, set TALK switch (rear panel) to TALK ONLY unless instructions are to be received through the IEEE-488 bus.

c. Switch EXTERNAL BIAS OFF (front panel).

d. Press the POWER button "in", so that it stays in the depressed position. Self-check codes will show briefly, indicating that the instrument is automatically executing a power-up routine that includes self checks.

(To turn the instrument off, push and release the POWER button and leave it in the "out" position.)

e. Wait until keyboard lights indicate MEASURE, VALUE, SLOW, CONT (or TRIGGERED), SERIES.

If they do not, there are two possible explanations: self-check fault and keyboard lock. If a fault is detected in the self-check, measurements are blocked and an error code remains displayed. Under some conditions, the block to operation can be bypassed. (See paragraph 3.13.) If the keyboard is locked, all of those keyboard indicators remain unlit except MEASURE and/or REMOTE CONTROL --and all previously programmed test conditions, limits, . etc are reestablished. To unlock it, see paragraph 3.9.

### 3.1.3 Zeroing

Before measurement, zero the Digibridge as follows. In this process, the instrument automatically measures stray parameters and retains the data, which it uses to correct measurements so that results represent parameters of the DUT alone, without (for example) test-fixture or adaptor capacitance.

a. Conditions.

SLOW measure rate, 1 V test voltage (default), RANGE HELD indicator NOT lit.

b. Open Circuit.

**Press** [FUNCTION] key (if necessary) to select MEASURE function.

**Press** [MEASURE MODE] key (if necessary) to select TRIGGERED mode.

**If** any test-fixture adaptors are to be used, install and position them for use. (See paragraph 3.2.) For the 1689M, connect the remote test fixture or at least the BNC cables and adaptors that will contact the DUT.

**Be** sure that the test fixture is open circuited.

**If** you want this "zero" process to echo a display of 00000, press the [Cs/D] key. However doing so will disable automatic parameter selection. (See paragraph 3.1.4, step b.)

**Press** these keys deliberately: [1] [6] [8] [9] [=] [SHIFT] [OPEN].

**Note:** the GO indicator being lit and two zeros confirm the previous step.

Watch the GO indicator on the keyboard; not one on any remote test fixture.

**Keep** hands and objects at least 10 cm (4 in.) from test fixture.

**Press** the START button. The GO indication disappears.

**Wait** for the GO indicator to be lit again.

c. Short Circuit.

**Short** the fixture with a clean copper wire (AWG 18 to 30), length 5 to 8 cm.

**Press** these keys: [1] [6] [8] [9] [=] [SHIFT] [SHORT].

**Note:** the GO indicator being lit and two fives confirm the previous step.

**Press** the START button. The GO indication disappears.

**Wait** for the GO indicator to be lit again.

**Remove** the short circuit.

NOTE For best accuracy:

Repeat this procedure daily and after changing test-fixture adaptors or frequency.

### 3.1.4 Routine Measurement

a. Verify or select measurement conditions as follows (indicated by keyboard lights); press the adjacent key to change a selection.

**Function:** MEASURE ([FUNCTION] key), a necessary selection

**Display:** VALUE ([DISPLAY] key), for normal RLC/QDR results

**Measure rate:** SLOW ([MEASURE RATE] key), for best accuracy

**Measure mode:** TRIGGERED ([MEASURE MODE] key), optional

**Equivalent circuit:** SERIES ([EQUIVALENT CIRCUIT] key) --see paragraph 3.3

If you are in doubt about how to connect the device to be tested with the Digibridge, refer to paragraph 3.2, below.

b. To measure *any passive component* (without knowing whether it is essentially a resistor, inductor, or capacitor), use "automatic parameter selection". This feature is provided at power-up and remains enabled as long as you do NOT select any particular parameter. (Automatic parameter selection can be disabled by pressing the [Cs/D] key, for example. Once disabled, this feature can be enabled again by selecting the ENTER function and then pressing these keys:

[1][=] [SHIFT] [SPECIAL] [7].)

Place DUT in test fixture. Press START. (See note below.) The RLC display and units indicator show the principal measured value and the basic parameter, thus identifying the DUT. The QDR display shows the measured Q if the principal units are ohms or henries; the measured D if they are farads.

#### NOTE

Use either the Digibridge START button or the start bar on the 1689-9605 test fixture (if properly connected).

In steps c, d, e, f, the parameters to be measured are specified by the user.

c. To measure *C and D of a Capacitor* (C Range .00001 pF to 99999 uF, D range .0001 to 9999): Press [Cs/D]. Place capacitor in test fixture. Press START. The RLC display shows Cs (series capacitance) and units (uF, nF, pF); the QDR display shows D (dissipation factor). {If "NEG RLC" is lit, DUT is inductive.}

d. To measure *C and R of a Capacitor* (C Range .00001 nF to 99999 uF, R range .0001 ohm to 9999 kilohm): Press [Cs/Rs]. Place capacitor in test fixture. Press START. The RLC display shows Cs (series capacitance) and units (uF, nF); the QDR display shows Rs (equivalent series resistance) and units (ohms, kilohms). {If "NEG RLC" is lit, DUT is inductive.}

e. To measure *Land Q of an Inductor* (L range .00001 mH to 99999 H, Q range .0001 to 9999): Press [Ls/Q]. Place inductor in test fixture. Press START. The RLC display shows Ls (series inductance) and units (mH, H); the QDR display shows Q (quality factor). {If "NEG RLC" is lit, DUT is capacitive.}

f. To measure *R and Q of a Resistor* (R range .00001 ohm to 99999 kilohms, Q range .0001 to 9999): Press [Rs/Q]. Place resistor in test fixture. Press START. The RLC display shows Rs (series resistance) and units (ohms, kilohms); the QDR display shows Q (quality factor). {If "NEG QDR" is lit, DUT is capacitive; if not lit, DUT is inductive.}

NOTE: This procedure is basic; there are many alternatives described later. You can select and program for other parameters, equivalent circuits, types of results displayed, test conditions, measurement rate, and bin sorting, etc.

## 3.2 CONNECTING THE DUT

### 3.2.1 General

Connect the "device under test" (DUT), whose parameters are to be measured.

#### WARNING

Charged capacitors can be dangerous, even lethal. Never handle their terminals if they have been charged to more than 80 V. Routine discharging procedures may not be perfectly dependable.

#### NOTE

Clean the leads or the DUT if they are noticeably dirty, even though the test-fixture contacts will usually bite through a film of wax to provide adequate connections.

### 3.2.2 Using the Integral Test Fixture on the 1689 Digibridge for Radial-Lead DUTs Figure 3-1.

NOTE: For use of a similar *remote* test fixture, refer to paragraph 3.2.4.

If the DUT is a radial-lead component or has parallel leads at one side, insert them into the Digibridge test-fixture slots as described below.

The test fixture provided on the front ledge of the 1689 Digibridge provides convenient, reliable, guarded 4-terminal connection to any common radial-lead or (with adaptors that are provided) an axial-lead component part.

The slots in the test fixture accommodate wires with diameters from 0.25 mm (.01 in., AWG 30) to 1 mm (.04 in., AWG 18), spaced from 4 to 98 mm apart (0.16 to 3.9 in.) or equivalent strip conductors. Each "radial" wire must be at least 4 mm long (0.16 in.). The divider between the test slots contains a shield, at guard potential, with its edges semi-exposed. The tapped holes (6-32 thread) at the left and right ends of the test fixture are also grounded, to connect the shields of extender cables.

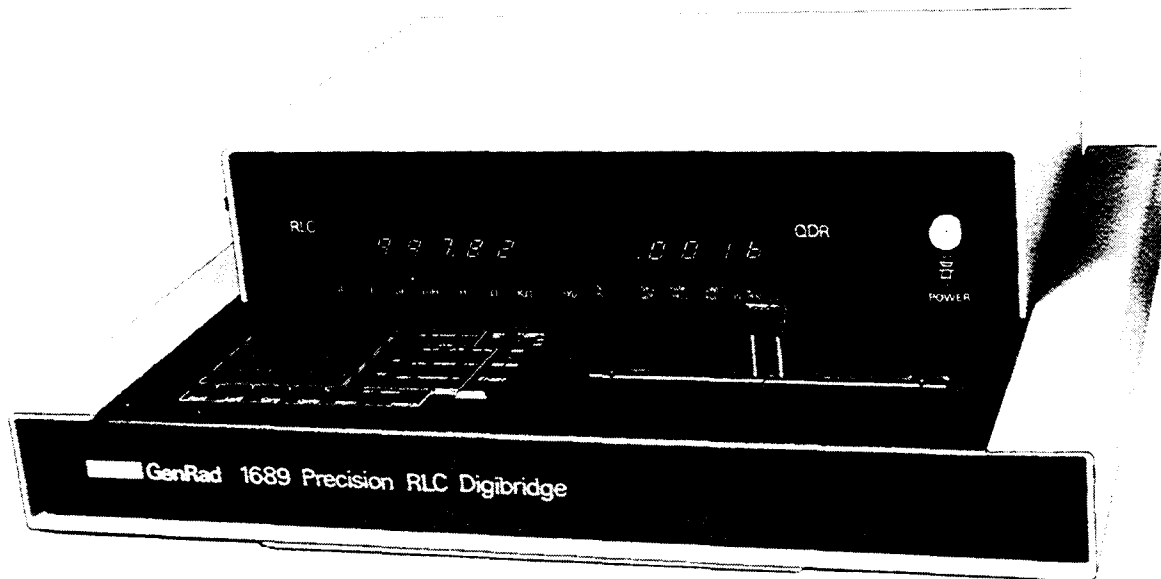

Figure 3-1. A radial-lead DUT is inserted into the test fixture.

**NOTE**

If any adaptor(s) , described below, are in place, remove them before attempting to insert a radiallead DUT.

**3.2.3 Using the Test-Fixture Adaptors for Axial-Lead DUTs**

**Figure 3-2.**

If the DUT is an axial-lead component or has leads at opposite ends, insert the leads into the test fixture adaptor's slots as shown in the accompanying figure and described below. NOTE: This description applies to the built-in test fixture of the 1689 Digibridge and also to remote test fixtures 1689-9600 and 1689-9605.

Install the test-fixture adaptors, supplied, as shown; put one in each slot of the test fixture, by pushing vertically downward. Slide the adaptors together or apart so the body of the DUT will fit easily between them.

Notice that the contacts inside the adaptor are off center; be sure to orient the adaptors so the contacts are close to the body of the DUT, especially if it has short or fragile leads.

The adaptors accommodate wires with diameters up to 1.5 mm (.06 in., AWG 15). The body of the DUT that will fit between these adaptors can be 80 mm long and 44 mm diameter (3.1 x 1.7 in.) maximum. Each "axial" wire must be at least 3 mm long (0.12 in.). The overall length of the DUT, including the axial wires must be at least 22 mm (0.866 in.).

Insert the DUT so that one lead makes connection on the left side of the test fixture, the other lead on the right side. Insertion and removal are smooth, easy operations and connections are reliable if leads are reasonably clean and straight. Press the DUT down so that the leads enter the slots in the adaptors as far as they go easily.

Be sure to remove any obvious dirt from leads before inserting them. The test-fixture contacts will wipe through a film of wax, but can become clogged and ineffectual if dirty leads are inserted repeatedly.

Be sure to insert only one thing into each half of the test fixture, at anyone time. (If any object is inserted into the same slot with a DUT lead, it will probably NOT make true "Kelvin" connections.)

### NOTE

For a DUT with very short leads, it is important to orient each adaptor so that its internal contacts (which are off center) are clooe to the DUT. To remove each adaptor, lift with a gentle tilt left or right (never forward or back).

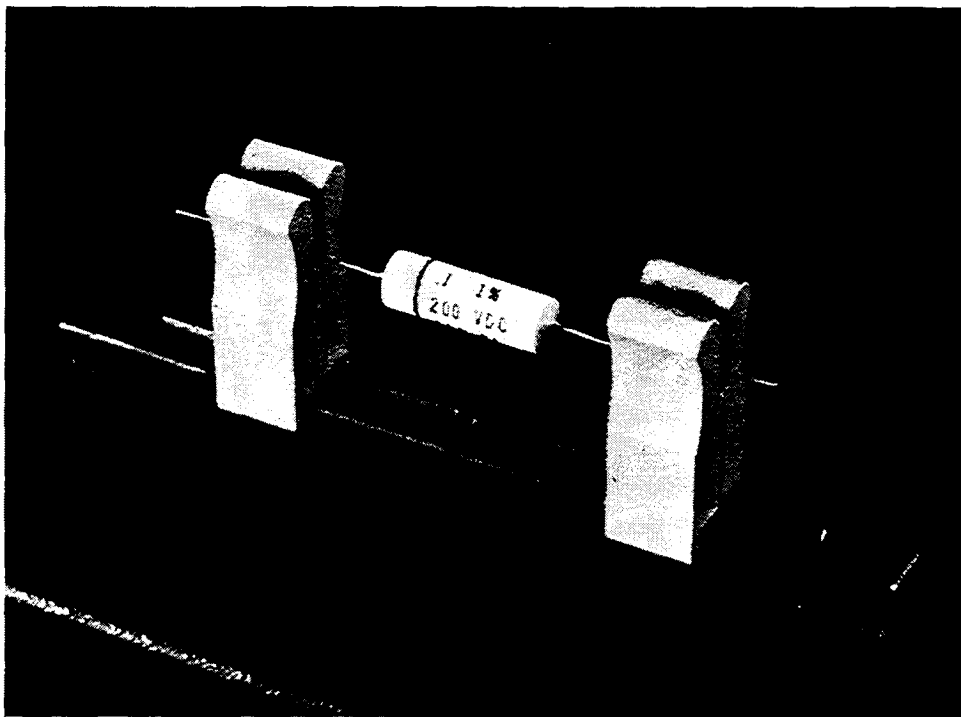

Figure 3-2. Use of the adaptors (supplied) for connection of an axial-lead DUT to the Digibridge test fixture.

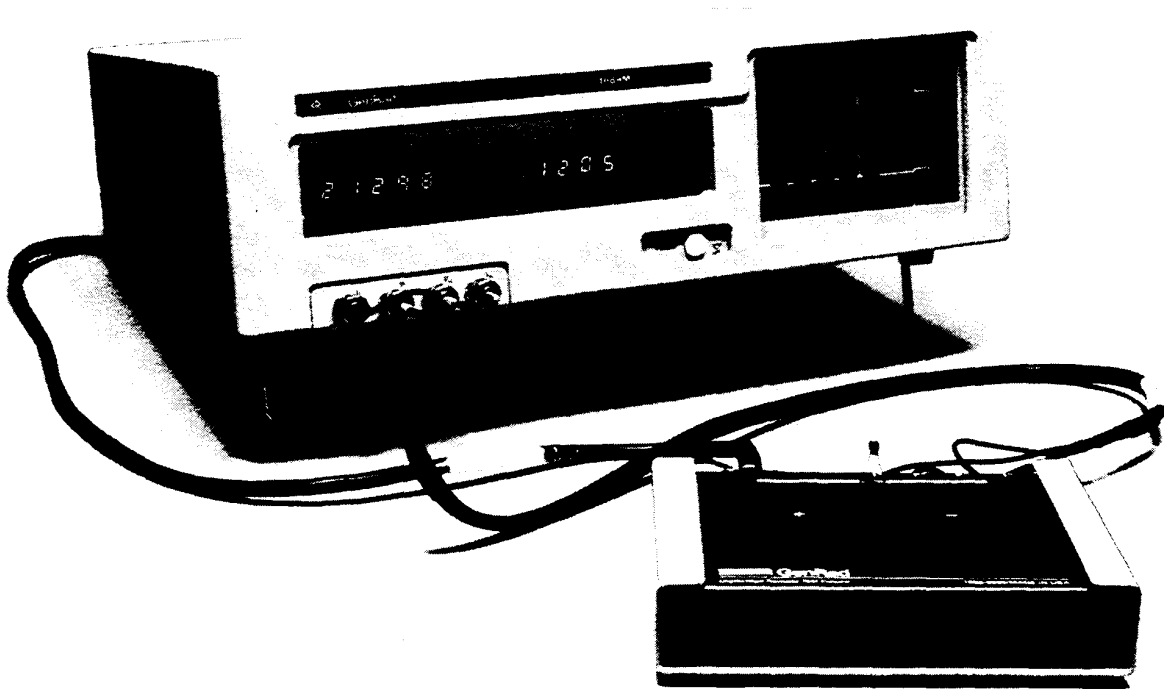

Figure 3-3. Remote test fixture (1689-9605), connected to 1689M Digibridge tester.

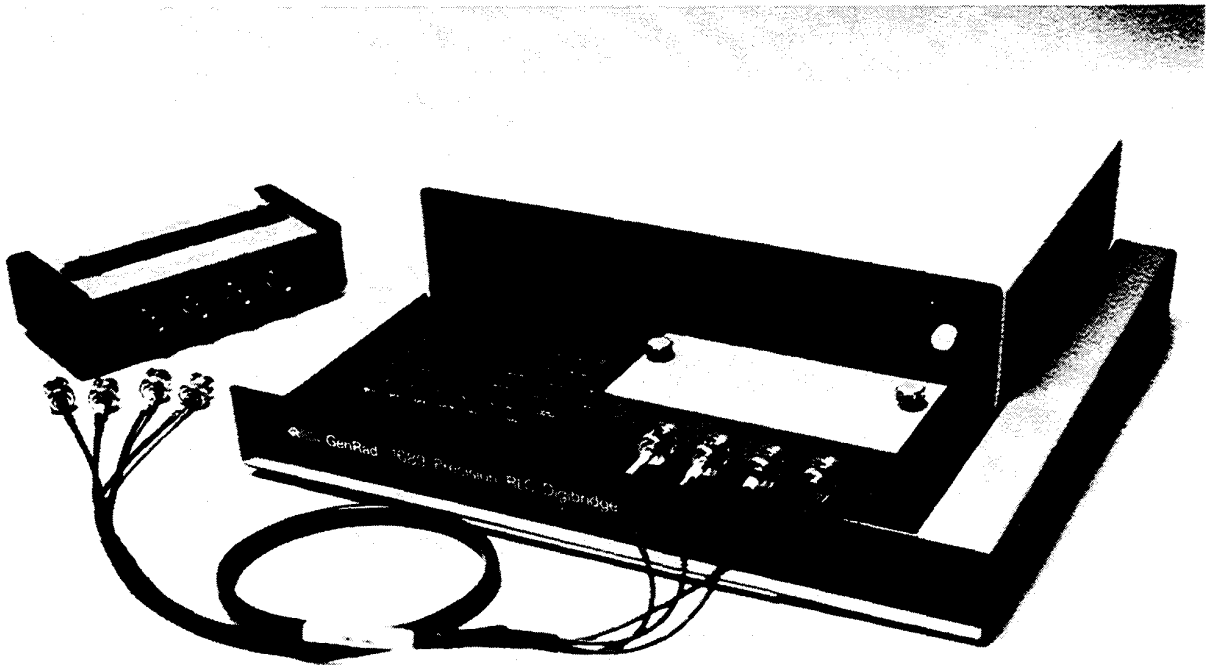

Figure 3-4. Remote test fixture (1689-9600), connected to 1689 Digibridge tester.

**3.2.4 The 1689-9600 or -9605 Remote Test Fixture (with -9602 BNC Cable) Figures 3-3,3-4.**

Connection of the DUT at a remote test fixture normally requires:

- Remote** Test Fixture 1689-9600, 1689-9605, or equivalent special fixture.
- BNC Cable Assembly** 1689-9602 ---supplied with 1689M Digibridge
- BNC Adaptor** 1689-9601 -----NOT needed with 1689MDigibridge

This remote test fixture functions like the one supplied on the 1689 Digibridge. True "Kelvin" connections are made at the points of contact with the DUT leads. The recommended cable should be used (rather than any randomly chosen BNC patch cords) because the known cable parameters enable you to make corrections for best accuracy. Install the remote test fixture as follows.

- a. Remove any adaptors, cables, etc, if present, from the DUT port of the instrument (test fixture of 1689 or BNC connectors of 1689M).
- b. If the instrument is a 1689, plug the BNC adaptor into the integral test fixture, with the BNC connectors facing forward. Lock the connection with the 2 captive thumb screws. (The screws must be seated to complete the ground connection.)
- c. Connect the BNC cable assembly to the Digibridge and to the remote test fixture as indicated in Table 3-1. Note that red designates leads that may be "hot". (When bias is applied, they carry dc negative voltage with respect to ground.)

**Table 3-1: REMOTE TEST FIXTURE CONNECTIONS VIA BNC CABLE**

Test-Circuit Function	Bias Polarity	BNC Connector at Digibridge	Color Code on 1689-9602 Cable	Connection at 1689-9600/-9605 Test Fixture *
IL (current, low)	+	Left	Black	I+, Left
PL (potential, low)	+	Left-center	Black/white	P+, Left-center
PH (potential, high)	-	Right-center	Red/white	P-, Right-center
IH (current, high)	-	Right	Red	I-, Right

-----  
 \* Left and right are defined with the fixture oriented for reading the legend.

d. For the 1689-9605 remote test fixture ---in order to activate the "Start" bar and the GO/NO-GO lights --connect the 1689-2400 Remote Tester Cable (supplied with the fixture) as follows. Connect one end to the HANDLER INTERFACE connector behind the instrument. Connect the other end to a similar connector behind the fixture.

e. Before making measurements, be sure to repeat the zeroing procedure (open circuit and short circuit), as described in paragraph 3.1.3.

NOTE: User provided cables and/or remote test fixtures can be used, particularly if the DUT is to be handled automatically. (See paragraph 3.11 about handlers.) For notes on cable and fixture capacitance and zeroing, see paragraph 3.2.7, below.



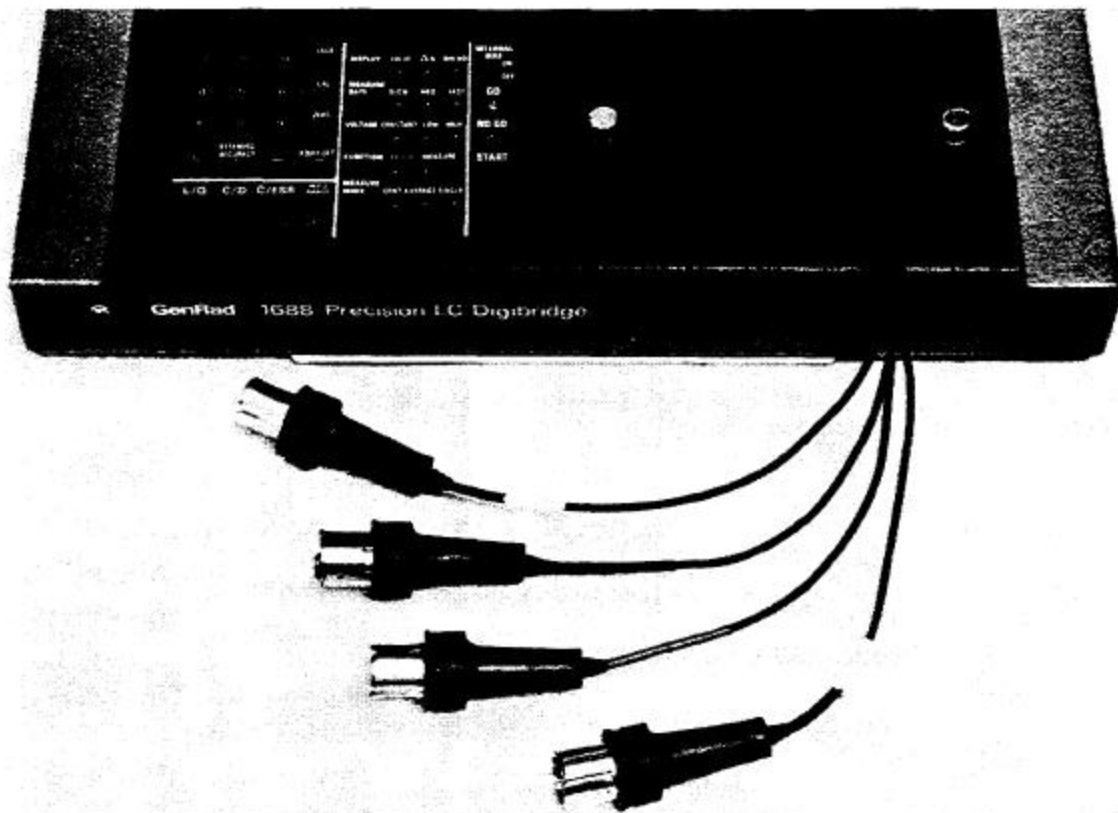

Figure 3-5. The type 874 extender cable is shown plugged into a Digibridge test fixture. Notice that the two thumb screws must be hand tightened for the guard connection (shields of cable).

### 3.2.5 The 1688-9800 Extender Cable ("Type 874" Connectors)

Figure 3-5.

The accessory extender cable 1688-9600 can be used to connect a DUT that is multiterminal, physically large, or otherwise unsuited for the built-in test fixture. This low-capacitance cable is used, for example, to connect type-874 equipped impedance standards or a special test fixture. The cable tips are type 874 coaxial connectors, which mate with a broad line of components and adaptors. Make connections as follows.

- a. Remove the adaptors, if present, from the test fixture (front of 1689 or remote type 1689-9600 or 1689-9605 used with 1689M).
- b. Plug the single-connector end of the extender cable into the test fixture so that its blades enter both slots and the cable lies away from the display panel (or away from the BNC connectors of the remote test fixture). Lock the connector with the two captive thumb screws.

c. Using the type 874 connectors, connect to the DUT with careful attention to the following color code.

IL (current, low)	Black/black	Connect to first (+) main terminal of DUT.
PL (potential, low)	Black/white	Connect to first main terminal of DUT.
PH (potential, high)	Red/white	Connect to second (-) main terminal of DUT.
IH (current, high)	Red/red	Connect to second main terminal of DUT.
Guard (shield or gnd)	Outer contacts	Connect to shield or case of DUT, if any, <i>only</i> if isolated from main terminals.

Notice that the 2 cables with red must connect to the same end of the DUT, through a coaxial tee if the DUT is a 2-terminal or 3-terminal device; the 2 cables labeled with black, connect to the other end, similarly. Connection of guard, via the outer portion of the coaxial connector, should be to the shield or case of the DUT, *but NOT to either of the two main terminals.*

### 3.2.6 The 1657-9600 Extender Cable (Banana Plugs) and the BNC Cable with Banana Plug Adaptors

*1657-9600 Extender Cable* (Recommended for 1689 Digibridge)

The accessory extender cable 1657-9600 is available to connect to DUTs that are multiterminal, physically large, or otherwise unsuited for the built-in test fixture. (Refer to Table 1-3.) This cable is particularly convenient for connecting multiterminal components with binding posts that accommodate banana plugs.

a. Remove the adaptors, if present, from the test fixture.

b. Plug the single-connector end of the extender cable into the Digibridge test fixture so that its blades enter both slots and the cable lies away from the display panel. Lock the connector with the two captive thumb screws.

c. Note the color coding of the five banana plugs. Be sure that the "low" terminals (both potential and current) connect to one end of the DUT and the "high" terminals to the other end. Connect guard to a shield if any, but not to either end of the DUT. Refer to the following tabulation.

IL (current, low)	Black	Connect to first (+) main terminal of DUT.
PL (potential, low)	Black/white	Connect to first main terminal of DUT.
PH (potential, high)	Red/white	Connect to second (-) main terminal of DUT.
IH (current, high)	Red	Connect to second main terminal of DUT.
Guard (shield or gnd)	Black/green	Connect to shield of DUT, if any, but <i>not</i> to either main terminal.

NOTE: The Kelvin junctions (IL & PL) and (PH & IH) can be made by using stackable banana plugs, for convenience ---so that only one connection is sufficient at each main terminal of the DUT. Then, to obtain best results, it is very important to locate the banana-plug hardware in final position while zeroing (paragraph 3.1.3).

*BNC Cable with Adaptors to Banana Plugs (Recommended for 1689M Digibridge)*

This arrangement used for the same applications as described above.

- a. Connect 1689-9602 BNC cable to 1689M Digibridge as specified in Table 3-1.
- b. Connect the set of four BNC-to-banana-plug adaptors to the free end of this cable. (One of these adaptors, supplied with 1689M, has a pigtail for connecting "guard", which may not be identified with the colors that the table indicates.)
- c. Connect the banana plugs (and guard, if appropriate) to the DOT as described above.

**NOTE**

Avoid contact between outer conductors of BNC-to-banana adaptors. Otherwise, measurements with high test frequency are liable to have errors that result from the changing mutual inductances between shields of cable conductors.

**3.2.7 The Effects of Cable and Fixture Capacitances**

It is important to use very low-capacitance shielded wire for cables, not only for accuracy, but also to minimize resonance effects in the measurement of large inductance at high frequency.

*The Capacitances that are Most Liable to Affect Accuracy.* Any test fixture extension cable adds a bit of capacitance in parallel with the DOT (because shielding of the leads is imperfect) and more between each terminal and ground. The zeroing process (paragraph 3.1.3) will compensate fully for the capacitances between cables in any normal test setup.

However, capacitance between ground and the "low" connections at the DUT (C from ground to IL and C from ground to PL, in parallel, designated Csn) can affect measurement accuracy of very-high-impedance DUTs at high frequencies.

*Zeroing.* Be sure to repeat either the entire power-up procedure or at least the open-circuit and short-circuit zeroing procedure after any change in test fixtures or their cable connections.

*Calculating the Capacitance Loading Error.* The error due to this capacitance Csn is designated Ald ("additional error due to loading"). The magnitude of Ald can be calculated so that you know how significant it is and so that measurements can be corrected if desired. Refer to paragraph 3.6, Accuracy, subparagraph 7.



Figure 3-6. 1689-9603 tweezers connected to the 1689 Digibridge, with BNC adaptor.

### 3.2.8 The 1689-9603 Tweezers

Figure 3-6.

The 1689-9603 tweezers combine the two functions:

1. Tweezers for handling chip components, up to 0.5 in. (12 mm) thick.
2. Test fixture for measuring these components, if their terminals are on opposite faces.

With these tweezers, you can conveniently pick up a tiny chip component, measure it, and put it in a bin (or decide what else to do with it), all in one operation.

Installation on the 1689 Digibridge requires BNC Adaptor 1689-9601 ---not needed with 1689M Digibridge. Install the tweezers as follows.

- a. Remove any adaptors, cables, etc, if present, from the DUT port of the instrument (test fixture of 1689 or BNC connectors of 1689M).
- b. If the instrument is a 1689, plug the 1689-9601 BNC adaptor into the integral test fixture, with the BNC connectors facing forward. Lock the connection with the 2 captive thumb screws, which must be seated to complete the ground connection. (The model 1689M requires no adaptor.)
- c. Connect the BNC cables of the tweezer assembly to the Digibridge as indicated in Table 3-1. In this table, ignore the last column (about the remote test fixture). Note that red designates leads that may be "hot". (When bias is applied, they carry dc negative voltage with respect to ground.)

d. If dc bias is used (see paragraph 3.7), notice that the faces of the tweezers are labeled "+" and "-" to indicate bias polarity.

### 3.2.9 The 1689-9606 Kelvin Clip Cable

The 1689-9606 Kelvin Clip Cable provides a means for easily making four terminal (Kelvin) connections to passive components. This cable is especially useful for testing low impedance devices or devices with large nonstandard terminations, such as electrolytic capacitors or inductors.

Install Kelvin Clips as follows:

a. Remove any adaptors, cables, etc., if present, from the DUT port of the instrument.

b. Connect the BNC cables of the Kelvin Clips assembly to the Digibridge as indicated in Table 3-1. Note that red designates leads that may be "hot". (When bias is applied, they carry dc negative voltage with respect to ground).

c. If dc bias is used (see paragraph 3.7), notice that the faces of the Kelvin Clips are labeled "+" and "-" to indicate bias polarity.

NOTE: Instructions supplied with the 1689-9606 may differ from Table 3-1. It is important to be aware that if DC BIAS is used, that it is a negative voltage and that it is applied to the ill lead from the instrument.

## 3.3 MEASUREMENT PARAMETERS, RESULTS DISPLAYS, AND OUTPUTS

### 3.3.1 Parameters (R/Q, L/Q, C/D, C/R)

*Automatic Selection.* The Digibridge as powered up provides you with automatic selection of parameters (unless keyboard has been locked with a particular parameter selected).

This feature enables you to measure any passive component (without knowing whether it is essentially a resistor, inductor, or capacitor). It is provided at power-up and remains enabled as long as you do NOT select any particular parameter.

Automatic parameter selection can be disabled by pressing any parameter key, such as the [Cs/D] key, for example. Once disabled, this feature can be enabled again by selecting the ENTER function and then pressing these keys:

[1] [=] [SHIFT] [SPECIAL] [7]

To select parameter automatically, the Digibridge calculates Q: if  $|Q| < 0.125$ , R is selected; otherwise, for positive Q, L is selected; and for negative Q, C is selected. (The sign of Q is the same as the sign of the reactive component of impedance.)

*Manual Selection* To select the parameter to be measured:

a. Press one of the 4 parameter keys: [R/Q, L/Q, C/D, C/R].

b. Use the [EQUIVALENT CIRCUIT] key to select SERIES or PARALLEL. Note: When you select SERIES equivalent ckt, the 4 keys obtain  $R_s/Q$ ,  $L_s/Q$ ,  $C_s/D$  and  $C_s/R_s$ . When you select PARALLEL equiv ckt, the 4 keys obtain  $R_p/Q$ ,  $L_p/Q$ ,  $C_p/D$  and  $C_p/R_p$ .

Note: equivalent circuits are discussed below, in paragraph 3.3.2.

For an inductor select LjQ; for a capacitor, either C/D or C/R; for a resistor, R/Q. There will be an immediate confirmation on the display panel, where appropriate units indicators will be lit. (However, do not attempt to select the unit multiplier.) The Digibridge will automatically switch to the appropriate multiplier from nF to pF for example --, unless RANGE is HELD, when it makes a measurement. The result will be displayed in terms of the parameters and equivalent circuit that you select, (even if the DUT has the opposite kind of reactance --see below).

Note: Observing the results displays can be helpful in deciding whether you have made the best parameter selection. (See below.) Displays are discussed further in paragraph 3.3.3.

*The NEG RLC Indicator.* If the NEG RLC indicator on the main display panel is lit with an L or C

value displayed, the DUT reactance is opposite to the selected parameter. As a rule, you should change parameter (usually select L instead of C or vice versa) so that a positive L or C value display can be obtained. However, the displayed negative value of L or C is mathematically correct and (without the minus sign) is in fact the value that will resonate with the DUT at the test frequency. Notice that the appearance of a device can be misleading. (For example, an inductor is capacitive if test frequency is above resonance; or a component part can be mislabeled or unlabeled.)

When the display is VALUE or BIN No., avoid incorrect choice of parameter by watching for the NEG RLC indicator on the display panel. If this indicator is lit, the principal parameter (L or C) was selected incorrectly. Try the opposite choice.

However, when the display is delta% or deltaRLC, a negative indication means that the measured value is less than the reference (stored nominal value), and the parameter is probably correct.

For more information about both the NEG RLC and the NEG QDR indicators, see paragraph 3.3.3.

### **3.3.2 Equivalent Circuits --Series, Parallel**

The results of R, L, or C measurements of many components depend on which of two equivalent circuits is chosen to represent it --series or parallel.

The more nearly "pure" the resistance or reactance, the more nearly identical are the "series" and "parallel" values of the principal parameter. However, if D is high or Q low, Cs differs substantially from Cp and Ls differs substantially from Lp; and these values are frequency dependent. Usually several measurements at frequencies near the desired evaluation will reveal that either series measurements are less frequency dependent than parallel, or the converse. The equivalent circuit that is less frequency dependent is the better model of the actual device.

We first give general rules for selection of measurement parameters, then some of the theory.

#### **Making The Selection**

The power-up selection is "series", confirmed by the SERIES indicator being lit, on the keyboard. To change the selection, press the [EQUIVALENT CIRCUIT] key.

*Specifications.* The manufacturer or principal user of the DUT probably specifies how to measure it. (Usually "series" is specified.) Refer also to the applicable MIL or EIA specifications. Select "parallel" or "series" and the test frequency according to the applicable specifications. If there are none known, be sure to specify with your results whether they are "parallel" or "series" and what the measurement frequency was.

*Suggested Test Conditions.*

Capacitors less than 10 pF: Parallel, 10 kHz.  
Capacitors from 10 to 400 pF: Series or Parallel, 10 kHz.  
Capacitors from 400 pF to 1 uF: Series, 1 kHz.  
Capacitors greater than 1 uF: Series, 0.1 or 0.12 kHz.

Unless otherwise specified or for special reasons, always select "series" for capacitors and inductors. This has traditionally been standard practice. For very small capacitance, select a higher measurement frequency for best accuracy. (Refer to paragraph 3.6.) Conversely, for very large capacitance, select a lower measurement frequency for best accuracy.

Inductors less than 10 uH: Series, 100 kHz.  
Inductors from 10 uH to 1 mH: Series, 10 kHz.  
Inductors from 1 mH to 1 H: Series, 1 kHz.  
Inductors greater than 1 H: Series, 0.1 kHz.

Select "series" as explained above. For very small inductance, select a higher measurement frequency for best accuracy. Conversely, for very large inductance, select a lower measurement frequency for best accuracy.

*Resistors, below about 1 kilohm:* Series, 1 kHz. Usually the specifications call for dc resistance, so select a low test frequency to minimize ac effects. Select "series" because the reactive component most likely to be present in a low resistance resistor is series inductance, which has no effect on the measurement of series R.

*Larger Resistors, between 1 kilohm and 10 megohms:* Parallel, 0.250 kHz.

*Resistors greater than 10 megohms:* Parallel, 0.030 kHz. As explained above, select a low test frequency. Select "parallel" because the reactive component most likely to be present in a high-resistance resistor is shunt capacitance, which has no effect on the measurement of parallel R. If the Q is less than 0.1, the measured  $R_p$  is probably very close to the dc resistance.

## **Theory --Series and Parallel Parameters**

## **Figure 3-7.**

An impedance that is neither pure reactance nor a pure resistance can be represented at any specific frequency by either a series or a parallel combination of resistance and reactance. The values of resistance and reactance used in the equivalent circuit depend on whether a series or parallel combination is used. Keeping this concept in mind will be valuable in operation of the instrument and interpreting its measurements.

The equivalent circuits are shown in the accompanying figure, together with useful equations relating them. Notice that the Digibridge measures the equivalent series components  $R_s$ ,  $L_s$ , or  $C_s$ , if you select SERIES EQUIVALENT CIRCUIT. It measures the parallel equivalent components  $R_p$ ,  $L_p$ , or  $C_p$  if you select PARALLEL. D and Q have the same value regardless whether series or parallel equivalent circuit is calculated.

### Resistance and Inductance

$$X = \omega L$$

$$Z = R_s + j\omega L_s \quad Z = \frac{j\omega L_p R_p}{R_p + j\omega L_p} \quad Z = \frac{R_p + jQ^2 \omega L_p}{R_p + j\omega L_p}$$

$$Q = \frac{1}{D} \quad Q = \frac{\omega L_s}{R_s} \quad Q = \frac{R_p}{\omega L_p}$$

$$L_s = \frac{Q^2}{1+Q^2} L_p \quad L_s = \frac{1}{1+D^2} L_p$$

$$L_p = \frac{1+Q^2}{Q^2} L_s \quad L_p = (1+D^2) R_s$$

$$R_s = \frac{\omega L_s}{Q} \quad R_p = Q\omega L_p \quad R_p = \frac{1}{G_p}$$

$$B_p = -\frac{1}{\omega L_p} \quad y = G_p - j\frac{1}{\omega C_p}$$

### Resistance and Capacitance

$$X_s = -\frac{1}{\omega C_s}$$

$$Z = R_s - j\frac{1}{\omega C_s} \quad Z = \frac{R_p}{1 + j\omega R_p C_p} \quad Z = \frac{D^2 R_p + 1/(j\omega C_p)}{1 + D^2}$$

$$D = \frac{1}{Q} \quad D = \omega R_s C_s \quad D = \frac{1}{\omega R_p C_p}$$

$$C_s = (1+D^2) C_p \quad C_p = \frac{1}{1+D^2} C_s$$

$$R_s = \frac{D^2}{1+D^2} R_p \quad R_p = \frac{1+D^2}{D^2} R_s$$

$$R_s = \frac{D}{\omega C_s} \quad R_p = \frac{1}{\omega C_p D} \quad R_p = \frac{1}{G_p}$$

$$B_p = \omega C_p \quad y = G_p + j\omega C_p$$

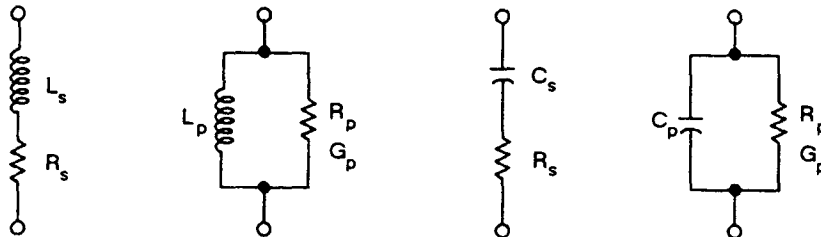

60046.0

Figure 3-7. Equivalent circuits and mathematical relationships for lossy inductors and capacitors.

*ESR for Capacitors.* The total loss of a capacitor can be expressed in several ways, including D and "ESR", which stands for "equivalent series resistance" and which is designated "R<sub>s</sub>" in the preceding paragraph. To obtain ESR, be sure that the SERIES indicator is lit; if you want ESR displayed simultaneously with C<sub>s</sub>, push the [C<sub>s</sub>/R<sub>s</sub>] parameter key; if you want the 5-place resolution for ESR, push the [R<sub>s</sub>/Q] key.

"Equivalent series resistance" is typically much larger than the actual "ohmic" series resistance of the wire leads and foils that are physically in series with the heart of a capacitor, because ESR includes also the effect of dielectric loss. ESR is related to D by the formula  $ESR = R_s = D/\omega C_s$  (where  $\omega$  represents "omega" = 2 pi times frequency).

*Parallel Equivalent Circuits for Inductors.* Even though it is customary to measure series inductance of inductors, there are situations in which the parallel equivalent circuit better represents the physical device. For small "air-core" inductors, the significant loss mechanism is usually "ohmic" or "copper loss" in the wire; and the series circuit is appropriate.



However, if there is an iron core, the significant loss mechanism may be "core loss" (caused by eddy currents and hysteresis); and the parallel equivalent circuit is appropriate, being a better model of the inductor. Whether this is true at any particular frequency should be determined by an understanding of the DUT, but probably it is so if the following is true: that measurements of  $L_p$  at two frequencies near the frequency of interest differ from each other less than do measurements of  $L_s$  at the same two frequencies.

### 3.3.3 Results Displayed

#### PRINCIPAL MEASUREMENT RESULTS

The principal Digibridge measurement will be presented on the left (RLC) part of the display panel in one of four ways; VALUE, deltaRLC, delta%, or BIN No., (only one way for any single measurement).

*VALUE, Selected by the [DISPLA Y] Key.* This measurement provides two displays: the principal one is RLC (resistance, inductance, or capacitance) and the secondary one is QDR (quality factor with R or 1, either dissipation factor or resistance with C). The VALUE selection is the power-up default and one of the selections of the [DISPLAY] key.

Read the measurement on the main displays. The RLC display is the principal measurement, complete with decimal point and units which are indicated by the light spot in the lower part of the display panel. The QDR display is Q if the selected parameter is R/Q or L/Q; it is D for C/D, or resistance (with units indicated) for C/R. Leading zeroes before the decimal point are automatically eliminated in most cases by positioning of the decimal point. Otherwise, such zeroes are blanked out.

*The NEG RLC Indicator.* If the NEG RLC indicator on the main display panel is lit with an L or C value displayed (or with parameter selection Lor C and BIN NO. displayed), the DUT reactance is opposite to the selected parameter. Generally, you should change parameter (usually select L instead of C or vice versa) so that a positive Lor C value display can be obtained. See paragraph 3.3.1.

However a negative indication when the display is delta% or deltaRLC means that the measured value is less than the reference (stored nominal value), and the parameter is probably correct.

*Delta Percent Displays, Selected by the [DISPLA Y]Key.* This presents the principal measurement (RLC) in terms of a percent difference above or below the nominal value last entered (i.e., a previously stored reference). Use this procedure.

a. Select ENTER with the [FUNCTION] key.

b. Select appropriate parameter and units with [EQUIVALENT CIRCUIT] and [R/Q, L/Q, C/D, or C/R] key. (Repeat keying will change unit multipliers.)

c. Enter the reference for delta percent by keying:

(Y)[=] [SHIFT] [NOM VALUE]

in which Y represents 1 to 6 numerical keys and (optionally) the decimal point key, depressed in sequence. Confirmation is shown (up to 5 digits) on the RLC display.

d. Select MEASURE with the [FUNCTION] key and delta% with the [DISPLAY] key.

e. Observe that the RLC display will now be in percent, not an electrical measurement unit. It is the difference of the measured principal value from the nominal value (the stored reference), expressed as a percent of the nominal value. If the NEG RLC indicator is lit, the measured value is less than the nominal value; and conversely, if not lit, the measured value is greater.

The secondary measurement result appears in the QDR display area, just as it would if the principal display were VALUE.

NOTE: If you wish to see the delta% display simultaneously with bin sorting (data output to handler or IEEE-488 bus), enter the bin limits first, as described in paragraph 3.8. Then (unless the last setting of nominal value happens to be the desired reference for percent difference) use the above procedure for setting up delta% displays.

*Delta RLC Display, Selected by the [DISPLAY]Key.* This selection is indicated by lighting BOTH indicators together: VALUE and delta%. The deltaRLC display is a difference from the stored nominal value, measured in the indicated electrical units, such as ohms, millihenries, or picofarads. The NEG RLC indicator is lit if the measured value is less than reference. The procedure for selecting deltaRLC displays is like the delta% procedure, above, except that the [DISPLAY] key is pressed repeatedly until *two* DISPLAY indicators (together labeled deltaRLC) are lit.

The secondary measurement result appears in the QDR display area, just as it would if the principal display were VALUE.

*Bin No.* Selected by using the [DISPLAY] key. When measurement is completed, the bin assignment will be shown on the left (RLC) display only, as a one-digit or two-digit number, with the following significance:

- 0 = No-Go because of the secondary (QDR) Limit
- 1 = Go, bin 1
- 2 = Go, bin 2
- ...Go, bin 3, 4, 5, ...12, or 13, as indicated.
- 14 = No-go by default (suits no other bin).

*Ratio Displays.* The Digibridge can be programmed to display a ratio instead of either measured value or delta percentage. Refer to paragraph 3.3.7.

## SECONDARY MEASUREMENT RESULTS

The secondary Digibridge measurement will be presented on the right (QDR) display panel, for each measurement if the DISPLAY selection is VALUE, delta%, or deltaRLC. There is no secondary display if the selection is BIN NO.

*The NEG QDR Indicator.* The NEG QDR indicator has the following meanings.

Parameter Selection	NEG QDR not lit	NEG QDR lit
R/Q	DUT is inductive	DUT is capacitive
L/Q, C/D, or C/R	Q, D, or R is positive	Q, D, or R is negative (see below)

If the secondary measurement is negative --Q, D, or R as calculated by the Digibridge when selected parameter is L/Q, C/D, or C/R --then there are two likely possibilities. If the Q or D value (whichever is being displayed) is very small, a small (acceptable) calibration and/or measurement error can lead to a negative result. (It should of course fall within the specified accuracy of the instrument.) Measurement error can be reduced by choice of measurement conditions, averaging, etc. Another possibility is that the DUT (as seen by the Digibridge)

really does have a negative loss factor. This situation might occur when you are measuring certain kinds of multiterminal networks or active devices.

#### NOTE

Improper connection of extender cables can cause a false indication of NEGATIVE QDR.

*DQ IN PPM, Selected by the [SHIFT][DQ in PPM] Keys.* For D or Q values less than .0100, selecting DQ in PPM improves the resolution by a factor of 100. For example, if the displayed D values of two capacitors are both .0001, changing to DQ in PPM might distinguish them by providing a reading of 138 ppm for one and 87 ppm for the other.

The "DQ in PPM" selection applies to the Q or D result only, and is effective for all selections of the [DISPLAY] key except BIN NO, and for all parameter selections except C/R.

When this selection is in effect: the DQ IN PPM indicator is lit; the display is always parts per million, without decimal point; if the display is blank, the D or Q value is greater than 9999 ppm (to obtain the value, cancel "DQ in PPM").

To cancel this selection, use the same keystrokes again: [SHIFT][DQ in PPM].

#### GO/NO-GO INDICATORS

If comparison is enabled, by a non-zero entry for "nominal value", and limits in at least one bin, a GO or NO-GO indication is provided at the keyboard, for every measurement. If you are using the 1689-9605 remote test fixture, a GO /NO-GO indication appears there also. (The display selection can be whatever you choose.). GO means the measurement falls in bin 1 through 13; NO-GO means bin 0 or 14.

#### 3.3.4 Units, Multipliers, and Blank Displays

Units of R, L, and C are determined entirely by your selection of parameter. Units multipliers are fixed by parameter, range, and frequency, except that selection of delta% changes the RLC display to a percentage. See Table 3-2.

Units of D and Q are dimensionless and are expressed as a decimal ratio, without multiplier --unless you select "DQ IN PPM", in which case D or Q is expressed in parts per million (see below). To obtain D or Q in percent, from the regular display, move the decimal point two places to the right. For example, a regular display of D = .0045 is equivalent to 0.45%

Table 3-2  
UNITS AND MULTIPLIERS FOR EACH RANGE

Parameter	Freq: Up to 0.1kHz				From 0.1 to 6kHz				From 6+ to 20kHz				Above 20kHz			
	1	2	3	4	1	2	3	4	1	2	3	4	1	2	3	4
R	K	K	ohm	ohm*	K	K	ohm	ohm	K	K	ohm	ohm	**	K	ohm	ohm
L	H	H	H	mH	H	H	mH	mH	H	mH	mH	mH	**	mH	mH	mH
C/D	nF	nF	uF	uF	pF	nF	nF	uF	pF	nF	nF	nF	**	pF	nF	nF
C/R***	nF	nF	uF	uF	nF	nF	nF	uF	nF	nF	nF	nF	**	nF	nF	uF

\* K represents "kilohms".

\*\* Range 1 is not used if frequency is above 20 kHz.

\*\*\* For C in nF, R is in kilohms. For C in uF, R is in ohms.

*Decimal Point Position.* The decimal point is automatically positioned for maximum resolution (i.e., so that the first significant digit or the first zero after the decimal point is in the first position in the display) with a few exceptions, as listed below. Of course, displays on low underrange or low extension of a held range may have a number of necessary zeros to right of the decimal point (and therefore reduced number of significant digits compared to the display area) because uni- and multipliers are fixed on anyone range. The above-mentioned exceptions are:

1. DQ IN PPM is always displayed without a decimal point, in ppm.
2. Delta% displays can resolve no less than 0.0001 % (i.e., 1 ppm).
3. Hysteresis is provided to reduce flickering, as explained below.

If the first digit of the measurement is 9, the decimal point for any measured-value display is left unchanged from its previous position, provided that so doing places that 9 in either the first or second position in the display area. (Notice that a number like 09XXX has resolution almost as fine as a number like 10XXX.)

For example, if the measured value is 99.985 nF, the display is a full 5 digits if the previous measuredvalue display was 12.345, 99.984, or 99.999; but the display is rounded off to 099.98 nF if the previous measuredvalue display was 100.02 or 1234.5 nF. Hysteresis is provided on both measured-value displays (RLC and QDR).

*Blanks in Measured- Value Displays.* If a measurement exceeds the capability of the display (99999 for RLC display, 9999 for QDR), the display is blank. If a measurement is less than 1 right-hand digit, the display is all zeros. If any leading zero before the decimal point must occupy a position in the display, that zero is blanked out. See below for programmed selection of digit blanking.

### 3.3.5 D/Q in PPM

The Digibridge can easily be programmed to display the secondary test result --when it it either D or Q --in parts per million. To choose this display, press:

[SHIFT][DQ in PPM] so that the DQ IN PPM indicator is lit.

To disable this option, repeat the same keystrokes so that the indicator is NOT lit.

Units of D and Q in PPM are dimensionless and are expressed as a decimal ratio, with the multiplier of 1,000,000 understood. To obtain D or Q in percent, from the DQ in PPM display, place a decimal point four places to the left of its "understood" position at the right-hand end of the display.

For example, a "DQ in PPM" display of  $D = 120$  ppm is equivalent to 0.012%.

### 3.3.6 Digit Blanking, a Special Function

If you want to truncate the measured-value displays you can deliberately blank out some of the least significant digits, using a special-function command (described in paragraph 3.10).

For example, to truncate the RLC display to 4 digits and the QDR display to 3 digits, press:

[1][.][1][=] [SHIFT] [SPECIAL] [4]

To disable such digit blanking (return to normal), press:

[0][.][0] [=] [SHIFT] [SPECIAL] [4]

### 3.3.7 Ratio Displays, Virtual Range Extensions, and Conductance Measurements, via a Special Function

The Digibridge can easily be programmed to display the principal test result (RLC) in the form of a ratio instead of the actual measured value. The ratio is either (measured value / stored nominal value) or the reciprocal of that. By suitable choice of the nominal value, you can obtain virtual range extensions for measurement of very large values or for fine resolution in measurement of very small values.

One use of the ratio display capability is to obtain results in terms of a multiple of some reference, which can be obtained if desired by measuring a real reference DUT.

*For Very Large R, L, or C.* Another use of the ratio display is to obtain measurements of very high values (in high overrange, i.e., exceeding 99999 of the highest range). For example, consider the measurement of capacitors with values near 200 mF (i.e., 0.2 farad). Any value greater than 99999 uF (99.999 mF) normally causes a blank display (because the unit multiplier on the highest C range is fixed and the display is limited to 5 digits).

However, if you enter a nominal value of 1000 uF, and enable calculation and display of the ratio "measurement/nominal", then measurement results can be interpreted as though they were in units of mF (although the ratio is really dimensionless and the unit indicators remain unlit). In this example, the measurement results can then be 199.99, 200.00, 200.01, etc. For much larger capacitance, the Digibridge will automatically move the decimal point, up to 99999 mF (i.e., 99.999 farads). For still larger values, you can make the nominal value larger.

*For Very Small R, L, or C.* Another use of the ratio display is to obtain better resolution of very small values (Otherwise the resolution can be no better than .00001 on the lowest range.) For example, consider the measurement of some inductors with values near 20 nH. Because the minimum measured value, and the resolution limit also, is .00001 mH, the normal measurement results can only be .00000, .00001, .00002, .00003 mH, etc, i.e., steps of 50% of the 20 nH value.

However, if you enter a nominal value of .001 mH, and enable calculation and display of the ratio "measurement/nominal", then measurement results can be interpreted as though they were in units of uH (although the ratio is really dimensionless and the unit indicators remain unlit). In this example, the measurement results can then be .01999, .02000, .02001, etc, i.e., steps of .0.5%, which is very fine resolution. By selecting a sufficiently small nominal value, you can obtain resolution that is better than the repeatability of measurements.

*Conductance Measurements.* Another use of ratio display is to obtain conductance values when the primary parameter is resistance. (The parameter selection is Rp/Q or possibly Rs/Q.) The inverse ratio display is used. To obtain results that are direct reading in mS, enter nominal value of 1 kilohm; for direct reading in uS, enter nominal value of 1000 kilohms.

For example, if you enter a nominal value of 1000 kilohms and enable calculation and display of "nominal/measurement", then measurement results can be interpreted as though they were in units of microsiemens (although the ratio is really dimensionless and the unit indicators remain unlit). In this example, for a 9.8765kilohm resistor, the primary display would be 101.25, which you can interpret as 101.25 uS.

*Procedure.* To program the Digibridge for ratio displays: enter desired nominal value in appropriate units of measurement; enable the special function, as follows.

a. With the [FUNCTION] key, select ENTER.

b. If the Digibridge has just completed a measurement of a DUT, so that the principal display already indicates the appropriate units of measurement, this step can probably be skipped. Otherwise, using the appropriate parameter key, select the units of the nominal value to be stored.

c. Enter the desired nominal value. For example, if the unit5 displayed on the panel are uF and you want to set up a ratio display that can be interpreted as mF, press:

[1][0][0][0][=][SHIFT][NOM VALUE]

d. Enable the desired special function; the pertinent commands are:

- To display measurement/nominal -- [2][=][SHIFT][SPECIAL][6]
- To display nominal/measurement -- [1][=][SHIFT][SPECIAL][6]
- To disable ratio displays ----- [0][=][SHIFT][SPECIAL][6]

e. To enable measurements, select MEASURE with the [FUNCTION] key.

f. To display the ratio in the left-hand display area, select VALUE with the [DISPLAY] key. After measurement, the right-hand display will be QDR, as usual; however, if the parameter selection is C/R, the unit5 for R will NOT be indicated.

**NOTE**

The Digibridge indicates that its principal measurement is a ratio by keeping ALL units and % indicators unlit.

If the parameter selection is C/R, the ratio display in the left-hand display area is accompanied by a resistance value in the QDR display area, *without units indication*. If the ambiguity in units (ohms or kilohms) must be resolved, the following method is suggested. The units can be determined for a typical DUT by temporarily disabling ratio display. While ratio is disabled, make measurements also with parameter selection C/D and observe the typical value of D. Now you are prepared to measure a batch of similar capacitors with ratio display. For any of them, a temporary change of parameter selection from C/R to C/D and another measurement will provide a quick check on whether its loss is similar to the loss of the typical DUT. If it is similar, for similar value of C at the same frequency, the R value is similar also. However if its D is much higher, the value of & is higher and Rp is lower, in approximate proportion to D.

### 3.4 PRINCIPAL TEST CONDITIONS

#### 3.4.1 Test Frequency

Power-up frequency is 1 kHz, unless the keyboard has been locked with some other choice. There are 503 available frequencies, as detailed below.

*Selection.* To select the test frequency, simply key in the desired frequency as follows, and the Digibridge will automatically obtain the nearest available one.

a. Select ENTER with the [FUNCTION] key.

b. Enter the desired frequency *in kilohertz* and press [=][SHIFT][FREQUENCY] in sequence, as follows.

For example, to select 500 Hz, press:

[.] [5][=] [SHIFT] [FREQUENCY]

Up to 6 digits and decimal point are valid in entry of desired frequency. For another example, if the desired frequency is 2300 Hz, key in:

[2] [.] [3] [=] [SHIFT] [FREQUENCY]

The actual frequency obtained appears immediately in the left (RLC) display area. In the example of desired frequency 2300 Hz, the display is 2.3077. The actual frequency obtained is always the closest one of the 503 available frequencies, which can be calculated from the following formulas, where n is always an integer in the range indicated:

(3 kHz)(C/n)	where n range is: 13...250 (freq .012000 to 0.23077 kHz)
(60 kHz)(C/n)	where n range is: 4...256 (freq 0.23438 to 15.000 kHz)
(200 kHz)(C/n)	where n range is: 2...13 (freq 15.385 to 100.00 kHz)

and where  $C = 1 + c$ , where c is a very small number between -.000099 and +.000099

The "nominal value" of an available frequency can be calculated from the appropriate one of the three formulas, the appropriate value of integer n, and by assuming that  $c = 0$ . The "corrected value" is more accurate, and is calculated in the same way except for using the true value of c.

The value of c is determined individually for each Digibridge as part of its factory calibration. If you want to find out what c is for your instrument, do the following. (The value will be in the range: -99 to 99 ppm.)

Select ENTER with the [FUNCTION] key. Then press:  
[SHIFT] [SPECIAL] [0]

*Indication.* Frequency display is the nominal value, to 5-digit resolution. This display is shown when frequency is selected (as described above) or by interrogation as follows' select ENTER function and then press:

[SHIFT] [FREQUENCY]

### 3.4.2 Test Voltage

The power-up test voltage is 1.0 volt rms, unless the keyboard has been locked with some other choice. There are a total of 255 choices: .005 to 1.275 V in increments of .005 V. To program the test voltage:

- a. Select ENTER with the [FUNCTION] key.
- b. Enter the desired voltage in volts and press [=][SHIFT][VOLTAGE], in sequence as follows. For example, to select 750 m V rms, press:

[.] [7][5][=] [SHIFT] [VOLTAGE]

The accuracy of the programmed source voltage is:

$\pm [(5\% + 2 \text{ mV}) (1 + .001 f^2)]$ , where  $f$  = value of test frequency in kHz.

The actual voltage across the DUT is never more than the source voltage, and depends on the DUT impedance and the source resistance of the Digibridge, for the range in use. The DUT voltage is close to the source voltage at the high-impedance end of each measurement range and lower at the low-impedance end. Normally, the smallest voltage across the DUT (if its impedance is 6.25 ohms or more) will be 20% of the source voltage; this is the case for resistors measured at the low end of each range. Refer to Table 3-3 for details. (This table is similar to the table of range constants in the specifications. However, the extreme limits are given here, on ranges 1 and 4.

For example, what is the voltage across the DUT if it is a 1-uF capacitor. Assume the test frequency is 1 kHz, the test voltage is 1.0 V, the CONSTANT VOLTAGE indicator is NOT lit and the RANGE HELD indicator is NOT lit. The Digibridge will measure on range 3, with 1.0 V behind source resistance of 400 ohms. The DUT reactance is 159 ohms and the voltage across it is 370 m V.

For comparison, what is the voltage across the same DUT if you select CONSTANT VOLTAGE (see paragraph 3.4.3) or if range 4 is held. In either case, the source, 1.0 V, is behind 25 ohms. The voltage across the DUT is 988 mV.



Table 3-3  
AUTORANGING MEASUREMENT RANGES AND SOURCE RESISTANCES

Range	Source Resistance	Principal Measured Parameter		
		Resistance	Capacitance	Inductance
1	97.4 kohms	max 99999 K	min .00001 pF	max 99999 H *
		mid 97.4 K	mid 1600 pF/f	mid 16 H/f
		min 25.6 K	max 6400 pF/f	min 4.1 H/f
2	6.4 kohms	max 25.6 K	min 6.4 nF/f	max 4100 mH/f
		mid 6.4 K	mid 25.3 nF/f	mid 1025 mH/f
		min 1.6 K	max 100. nF/f	min 256 mH/f
3	400 ohms	max 1600 ohms	min 100 nF/f	max 256 mH/f
		mid 400 ohms	mid 400 nF/f	mid 64 mH/f
		min 100 ohms	max 1600 nF/f	min 16 mH/f
4	25 ohms	max 100 ohms	min 1.6 uF/f	max 16 mH/f
		mid 25 ohms	mid 6.4 uF/f	mid 4 mH/f
		min .00001 ohm	max 99999 uF	min .00001 mH

\* "K" is kilohms; "f" is equal to the test frequency in kHz.

### 3.4.3 Constant-Voltage Source

If it is important to measure the DUT at a particular test voltage, then select the constant-voltage feature as follows. Press:

[SHIFT] [CONSTANT VOLTAGE]

so that the CONSTANT VOLTAGE indicator is lit. The Digibridge now retains a source resistance of 25 ohms for all ranges. The voltage is constant for any DUT impedance significantly larger than 25 ohms. An example is given in the preceding paragraph. Choosing this feature causes a reduction in measurement accuracy by a factor of three, as accounted for by Kcv in the accuracy specifications. (To disable the constant-voltage feature, press the same keys again.)

### 3.4.4 Constant-Current Source

To provide a constant-current source for any measurement, select and hold a range such that the source resistance is much larger than the DUT impedance. (See table of ranges, above.) Thus:

- a. Select ENTER function with the [FUNCTION] key.
- b. Select and hold a range as follows: (See also paragraph 3.10.)

For source resistance = 97.4 kilohms (range 1): press [1][=] [SHIFT] [SPECIAL] [1]

For source resistance = 6.4 kilohms (range 2): press [2][=] [SHIFT] [SPECIAL] [1]

For source resistance = 400 ohms (range 3): press [3][=][SHIFT] [SPECIAL] [1]

Source resistance is 25 ohms for range 4, which could be held similarly, if desired. However, if the DUT impedance is small compared to 25 ohms, the Digibridge will autorange to range 4 anyway.

c. Program the source voltage to be the product of the desired source current times the source resistance of the selected range. (Refer to paragraph 3.4.2 above, for programming the voltage.)

For example, if the DUT is a capacitor of nominal value near 0.4 uF, measured at about 1 kHz, its reactance is about 400 ohms. To measure it with constant-current source, select and hold range 2 (source resistance 6.4 kilohms). If the desired test current is 0.1 mA, program the source voltage too be 0.1 mA times 6.4 kilohms = 0.64 V. (Note that range 1 would provide still higher source resistance, but measurements would be less accurate, as shown by the factor  $C_x/C_{max}$  in the accuracy formula; see specifications in the front of the manual.)

### 3.4.5 Other Conditions

Other test conditions are described in other parts of this manual. Delay (programmable settling time before acquisition of data) ---paragraph 3.5.3. Averaging (selection of number of measurement to be averaged) --paragraph 3.6.3. Bias applied to the DUT (if it is a capacitor) ---refer to paragraph 3.7. Special functions ---refer to paragraph 3.10.

## 3.5 MEASUREMENT TIME AND MEASUREMENT RANGES

### 3.5.1 General

Selection of MEASURE RATE (SLOW, MEDIUM, and FAST) obviously relates to measurement time, providing the user with an easily made choice. (The slower rates provide greater accuracy.) Programming a DELAY (typically because the normal settling time is insufficient for a particular handler or biasing routine) also obviously affects measurement time.

In this paragraph, the many items that affect measurement time are explained. The measurement time (required to complete a measurement and display the results) depends not only on the selected measure rate, and programmed delay, but also on the presence or absence of the high-speed measurement option, test conditions, choice of display, whether data is being sent out to other devices, etc. The best combination of conditions for any particular job should be selected recognizing their effects on speed and accuracy. The following examples are representative; some of the numbers are approximate.

#### NOTE

Except where stated otherwise (as in paragraph 3.5.9), measurement time is given for the condition that the "quick acquisition" special function is NOT selected. So accuracy is as specified. (See front of manual.)

*1689M Digibridge.* The minimum measurement time is about 22 ms (about 45 measurements per second). The corresponding conditions are: measure rate = fast, IT factor set to 0.25 (integration time factor -paragraph 3.5.5), test frequency = 10 to 100 kHz, display selection = bin no., measure mode = continuous (which eliminates the settling time that is normal with triggered mode), 1689M Digibridge with high-speed measurement option, no data output via IEEE-488 bus.

For test frequency = 1 kHz, the minimum is about 32 ms (31 meas per second).  
For best accuracy (power-up conditions), the time is about 950 ms (1 meas/second).

If you do NOT have the high-speed option: minimum is about 34 ms (30 meas/sec). The corresponding conditions are: measure rate = fast, IT factor set to 0.25 (integration time factor -paragraph 3.5.5), test frequency = 10 to 100 kHz, display selection = bin no., measure mode = continuous (which eliminates the settling time that is normal with triggered mode), 1689M Digibridge without high-speed measurement option, no data output via IEEE-488 bus.

For test frequency = 1 kHz, the minimum is about 44 ms (23 measurements per second). In general, without the high-speed option, each measurement cycle is about 12 to 24 ms longer than it would be WITH the high-speed option.

NOTE: The 1689 Digibridge is somewhat slower than the 1689M, because of a difference in CPU clock rate.

1689 *Digibridge*. The minimum measurement time is about 33 ms (about 30 measurements per second). The corresponding conditions are: measure rate = fast, IT factor set to 0.25 (integration time factor --paragraph 3.5.5), test frequency = 10 to 100 kHz, display selection = bin no., measure mode = continuous (which eliminates the settling time that is normal with triggered mode), 1689 Digibridge with high-speed measurement option, no data output via IEEE-488 bus.

For test frequency = 1 kHz, the minimum is about 40 ms (25 meas per second). For best accuracy (power-up conditions), the time is about 970 ms (1 meas/second).

If you do NOT have the high-speed option: minimum is about 52 ms (19 meas/sec). The corresponding conditions are: measure rate = fast, IT factor set to 0.25 (integration time factor -paragraph 3.5.5), test frequency = 10 to 100 kHz, display selection = bin no., measure mode = continuous (which eliminates the settling time that is normal with triggered mode), 1689 Digibridge without high-speed measurement option, no data output via IEEE-488 bus.

For test frequency = 1 kHz, the minimum is about 59 ms (17 measurements per second). In general, without the high-speed option, each measurement cycle is about 19 to 38 ms longer than it would be WITH the high-speed option.

*Surprisingly Long Times*. Please be aware of the long time periods that *can* be required by this very fast measuring instrument.

#### NOTE

Under some conditions, testing can consume so much time that the operator might wonder whether the Digibridge is really operating. See below.

The longest single measurement cycle (including programmable delay set to 99999 ms and the specialfunction selection of "median value") is about 5 minutes. The Digibridge will execute up to 255 full-length cycles if you select maximum averaging, for a total of about 22 hours from START to display of measured result.

### 3.5.2 Measure Rate Selection at Keyboard

Choose one of 3 basic measurement rates with the [MEASURE RATE] key: SLOW, MEDIUM, or FAST. The continuous-mode rates are respectively about 1,5, and 12 measurements per second, if the other test conditions and programmable selections are left at normal power-up defaults, for the Digibridge with high-speed option.

The tradeoff is speed vs accuracy. The Digibridge will make a more precise and accurate measurement at a slower rate. For the above conditions, in very simplified terms, the basic accuracy is 0.02%, and the tradeoff is as follows:

SLOW rate, 1 measurement per second, 0.02% accuracy (or better);  
MEDIUM rate, 5 measurements per second, 0.05% accuracy (or better);  
FAST rate, 12 measurements per second, 0.12% accuracy (or better).

For details on accuracy, refer to the specifications. In the accuracy formulas, the effect of measure rate selection appears as the term "Ks".

### 3.5.3 Settling Time or Programmed Delay, in Triggered Measure Mode

For accurate measurements, it is often helpful to have a time delay between the START signal and the beginning of the first voltage measurement within the process of data conversion. Because such a delay allows time for switching transients to settle, and because more time is required for low test frequencies, the Digibridge normally incorporates "settling time" as follows.

If measure mode is CONTINUOUS, settling time = zero, programmed delay is disabled.

If measure mode is TRIGGERED, with measure rate FAST, settling time = 7 ms/f

If measure mode is TRIGGERED, with measure rate MEDIUM, settling time = 10 ms/f

If measure mode is TRIGGERED, with measure rate SLOW, settling time = 12 ms/f,

where f is equal to the test frequency in kHz. NOTE: the three times given above are verifiable in the ENTER function by pressing [SHIFT] [DELAY].

If measure mode is TRIGGERED, you can program any desired delay (from 0 to 99999 milliseconds) for transient voltages to settle, for mechanical handling to be completed and contacts to settle, etc. The Digibridge will pause for this much time after each START signal, before actually starting to take data.

Any programmed delay *replaces* the default "settling time"; and affects measurements only in TRIGGERED measure mode.

As an example, you can set delay to 2.5 ms, as follows.

Select ENTER with the [FUNCTION] key and press:

[2] [5][=] [SHIFT] [DELAY]

Programmed delay is typically required for measurement of capacitors with bias, if the measure mode is TRIGGERED. Refer to paragraph 3.7.

NOTE: In the CONTINUOUS measurement mode, there will be no settling time or programmed delay; the speed of the Digibridge makes it reasonable to disregard the first displayed result (which is liable to be in error for several reasons), and observe subsequent displays for consistency, which indicates that any transients have settled.

### 3.5.4 Measure Mode and Display Selection, Effects on Measurement Time

*Measure Mode TRIGGERED.* Selection of TRIGGERED mode introduces a settling time or delay between the START signal (which is necessary in this mode) and the beginning of data acquisition. Refer to paragraph 3.5.3, above.

*Measure Mode CONTINUOUS.* Selection of CONTINUOUS measure mode eliminates the delay described above. Notice that in continuous mode, the measurement being made when the DUT is connected to the Digibridge is erroneous. Subsequent measurements have the benefit of any effective "delay" furnished by the preceding ones.

*Display Selection.* The selection of BIN NO. display cuts 6 to 10 ms from the measurement time, compared to any other choice of display. Therefore, the BIN NO. choice is recommended for use with an automatic parts handler, if maximum throughput is desired and there is no need for the operator to observe values or percent differences.

More information about operation with a parts handler is given in paragraph 3.11.

### 3.5.5 Integration-Time Factor (a Special Function)

The length of time that the Digibridge spends integrating analog voltages in the process of data acquisition can be varied by programming a number called the "integration-time factor", if the measure rate is selected to be FAST or MEDIUM. In general, programming the I- T factor to a larger value allows the Digibridge to integrate over more cycles of the test signal, thus increasing the measurement time and enhancing the accuracy. (If the measure rate is SLOW, integration time is automatically fixed at a relatively large value, so that any programmed I-T factor has no effect on measurement time.)

The I- T factor is normally 1. You can program it to values in the range from 0.25 to 6. For I- T factor = 0.25, if measurement rate is FAST, the integration time is set to 1 ms if the test frequency is above 1 kHz, or to one period of the test signal if test frequency is less than 1 kHz. The following tabulation indicates the integration time for several combinations of I- T factor and measurement rate, for test frequency of 1 kHz.

	I - T FACTOR = 0.25	1	6	
FAST	1 ms	4 ms	24 ms	
MEDIUM	4 ms	17 ms	100 ms	
SLOW	100 ms	100 ms	100 ms	(not affected by I-T factor)

Programming the I- T factor is a special function, which is under keyboard control only if you have selected ENTER function. Then, for example, press these keys:

[.][2][5][=][SHIFT][SPECIAL][5] (to make the IT factor 0.25)

#### NOTE

"Max" rate is defined as the combination of FAST measure rate with I-T factor programmed to be 0.25. (The quick-acquisition special function is NOT used. See paragraph 3.10. With it, the measure rate would be even higher.)

The accuracy of measurement is affected by the value of 1- T factor (in combination with measure rate and other conditions). The tradeoff is illustrated as follows, for I-kHz test frequency, display = BIN NO., measurement mode = CONTINUOUS, with the high-speed option:

- 1- T factor = any value, SLOW rate, 0.02% accuracy, 1 measurement per second;
- 1- T factor = 1, MEDIUM rate, 0.05% accuracy, 5 measurements per second;
- I-T factor = 1, FAST rate, 0.12% accuracy, 12 measurements per second.
- 1- T factor = 0.25, FAST rate ("Max"), 0.25% accuracy, 25 measurements/second.

For details about accuracy, refer to the specifications, where the effect of programming 1- T factor to be 0.25 and selecting FAST rate is designated as "maximum measurement rate" in the table of values for the term "Ks".

### 3.5.6 Ranges, Range Changing, and Holding a Range to Save Time

#### RANGES and RANGE CHANGING

Descriptions of ranges, range extensions, and decimal point control are explained below.

*Basic Ranges.* The 4 basic ranges are numbered 1, 2, 3, 4, in order of decreasing impedance. Each basic range is approximately a factor of 16 wide. Refer to paragraph 3.4.2 for a table of ranges.

The word "upper" as used below refers to increasing measured value (which is the direction of increasing range number only if the principal measured parameter is capacitance). Similarly, the word "lower" as used below refers to decreasing measured value (which is the direction of decreasing range number only if the principal measured parameter is capacitance).

*Extensions.* Each of the 4 ranges goes beyond its basic range, with both upper and lower range extensions (also called overrange and underrange). Most of these extensions are seldom used because they overlap basic portions of other ranges and the Digibridge will automatically select the basic range unless you have selected "hold range" (see RANGE HELD indicator). Measurement units and multipliers in any range extension are the same as in the basic range. The fact that range definition depends on frequency causes a considerable variation in the width of range extensions. The lower limit is generally .00001, with all-zeros next; the upper limit is 99999, with all blanks next. Blanks in the measurement display are discussed below. In general, for any measurement within the specifications of the Digibridge, if a measurement can be displayed, it will be.

The only range extensions that are valid with autoranging are low underrange and high overrange, explained below.

*Low Underrange.* The "low" extension of the low range goes down to 1 count, with reduced accuracy. The smallest "I-count" increment in the display is the minimum measured value, given in the specifications in the front of this manual. Any measurement smaller than 1 count is displayed as all zeros.

NOTE: If the measured value is very small (even below one count) or very large (even over 99999), high-resolution measurements are possible using the ratio display. Refer to paragraph 3.7 or 3.10.

*High Overage.* The "high" extension of the high range goes up to the maximum display (all 9's, with the decimal point at the right), and finally to blank, with reduced accuracy. The high overrange is used for the very large values of RLC that exceed the basic high range.

*Autoranging.* Autoranging is normal; it is inhibited only if you select RANGE HELD. There is a slight hysteresis in the changeover from range to range to eliminate a possible cause of display flickering.

*Time Required to Change Range.* The Digibridge must almost complete a measurement cycle in the previously established range before starting measurement in the range to which it changes. The Digibridge completes the data acquisition and a large part of the calculation process before "deciding" whether the present range is best for the measured value. (If you have selected "median value", a special function, the Digibridge will go through basically three measurement cycles so that it has the median value for making the decision whether to change ranges.) Thus, measuring a lot of components that straddle a range boundary requires almost double the regular measurement time for every DUT that is on the opposite side of the boundary from its predecessor. (Note: if the Digibridge starts in range 1 to measure in range 4, four almost complete measurement cycles are required before the desired result appears.)

Therefore (at least in some measurement situations), maximum measurement speed requires range holding.

### **RANGE HOLDING**

*Why Hold a Range'?* The most important use of the range holding capability is to avoid range changes when the component is removed from the fixture when in the CONTINUOUS mode. With no component connected, the instrument will autorange to range 1. Thus, if range 1 is not selected when the component is in place, considerable time is lost by unnecessary autoranging. Another use of the range hold occurs when measuring components of the same nominal value whose actual values spread across the boundary between two ranges. If allowed to autorange, the units and decimal point may change with range which may be confusing to the operator. There are other uses for holding a range, such as obtaining the correct bias current or getting better guard capability. When a range is held that is not the range that autoranging would select, the accuracy may be sacrificed.

To inhibit autoranging, select the "range held" mode (RANGE HELD indicator lit) as described below - four methods.

*To Hold Present Range.* If the present range (as indicated by the measurement display) is the desired one, press:

[SHIFT][HOLD RANGE] to light the RANGE HELD indicator.

(To return to the normal autoranging feature, press the same two keys again, making the RANGE HELD indicator unlit.)

*To Hold the Range of a Sample DUT.* One way to get into the desired range is to measure a DUT known to be in that range, thus:

Measure the DUT as usual.  
Verify that the desired range is confirmed by the measurement display.  
Press: [SHIFT] [HOLD RANGE] to light the RANGE HELD indicator.

(To return to the normal autoranging feature, press the same two keys again, making the RANGE HELD indicator unlit.)

*To Hold the Range selected by Use of a Parameter Key.* Another way to get into the desired range is to use a parameter key, thus:

Select ENTER function with the [FUNCTION] key.

Press the appropriate parameter key (such as Cs/D) repeatedly, watching the units indicators. The range advances with each repetition, enabling you to determine the present range by the pattern of changes. Notice that there is *not* always a change of unit multiplier with each range change. (Refer to the table in paragraph 3.3.4.)

Press: [SHIFT] [HOLD RANGE] to light the RANGE HELD indicator.

(To return to the normal autoranging feature, press the same two keys again, making the RANGE HELD indicator unlit.)

*To Hold Range by Number.* If you know the desired range number (see table in paragraph 3.4.2), use the special function key as follows:

Select ENTER with the [FUNCTION] key. Then:

For range 1, press: [1] [=] [SHIFT] [SPECIAL] [1] For range 2, press: [2] [=]

[SHIFT] [SPECIAL] [1] For range 3, press: [3] [=] [SHIFT] [SPECIAL] [1]

For range 4, press: [4] [=] [SHIFT] [SPECIAL] [1]

(Note: for autoranging, press: [0] [=] [SHIFT] [SPECIAL] [1].)

### 3.5.7 Time Required for Obtaining Median Values and Averaging

Accuracy can be enhanced, at the cost of increased measurement time, by either or both of these methods. The time considerations and a brief instruction for selecting each method (while in the ENTER FUNCTION) are given here.

*Median Value.* This measurement time is somewhat less than triple the single measurement time, because three nearly complete measurements are made, from which the Digibridge selects the median for final results. To be more specific, each median-value measurement requires approximately as much time as three single measurements MINUS two of the three settling or delay time intervals and also MINUS about half of the calculation time. (The relative magnitudes of settling time, delay time, and calculation time in the single measurement cycle are illustrated in paragraph 3.5.10.)

Enabling and disabling median-value selection is a special function (paragraph 3.10). The enabling command is:

[1] [=] [SHIFT] [SPECIAL] [8] (See paragraph 3.6.4.)

*Averaging.* The measurement time is multiplied by the number of measurements (2 to 255), specified when averaging was programmed. To program the Digibridge to average, for example, 8 measurements, press:

[8] [=] [SHIFT] [AVERAGE] (See paragraph 3.6.3.)

*Both.* If both median value and averaging are enabled together, the measurement time is multiplied by almost three times the number specified when averaging was programmed. (The Digibridge finds the medians of groups of three measurements and then calculates the average of the medians.)



### 3.5.8 Time Required if IEEE-488 Output is Enabled

If data output is enabled, via IEEE-488 bus, additional time ---about 2 ms to 12 ms ---is required per measurement. This time requirement depends on the selected display and what data is being sent out, approximately as follows. (Refer to explanation of operation with the IEEE-488 interface, paragraph 3.12.)

	Regular Output Data Format							CBF *
Output data:	BIN	RLC	QDR	RLC, QDR	BIN, RLC	BIN, QDR	BIN, RLC, QDR	(any)
Display=BIN NO.	2	6	8	10	10	10	12	< 2 ms
Display=other	2	2	2	4	4	4	6	< 2 ms

\* Compacted Binary Format. If the compacted binary format is selected, data output requires less than 2 ms.

### 3.5.9 Effect of Selecting a Low Test Frequency on Measurement Time

Selection of a test frequency near or below 0.1 kHz affects measurement time in two ways: both settling time and data acquisition time depend on the period of the test signal. (Selection of test frequency near and above 1 kHz has little effect on measurement time, particularly if the integration time factor is left at default or set to a larger value.)

In general, measurement time includes the following two terms, which are additive. (Note: f is equal to the test frequency in kHz.)

**Settling** time (if measure mode is TRIGGERED and you have not programmed any DELAY) is  $[7 \text{ to } 12 \text{ ms}][1/f]$  In other words, approximately 10 periods.

**Data-acquisition** time is generally more than 9 periods (15 periods at SLOW measure rate), although relationship is not linear. (Refer to the summary below and to theory, Section 4.)

Notice that you can select a shorter DELAY and you can select the "quick-acquisition" feature. The latter saves more than one test-frequency period (with some reduction in accuracy).

#### NOTE

If a special function is selected that simplifies or eliminates data output for PASS results, the additional time described above is accordingly reduced or eliminated, except for FAIL results.

DELAY	DATA ACQUISITION	CALCULATION	DISPLAY	OUTPUT VIA IEEE-488 BUS
CONTINUOUS MODE: 0ms	(IRREGULAR, GENERALLY LESS THAN:)			NO OUTPUT: 0 ms
DEFAULT SETTING TIME FAST: $(1/f)$ 7 ms MEDIUM: $(1/f)$ 10 ms SLOW: $(1/f)$ 12 ms	FAST: $[9/f + 36 (ITF)]$ ms	WITH HI-SPEED OPT (ITF < 1): 25 ms (ITF ≥ 1): 34 ms	BIN NO: 0 ms	IF DISPLAY IS BIN NO. ONE { <ul style="list-style-type: none"> <li>BIN: 2 ms</li> <li>RLC: 6 ms</li> <li>QDR: 8 ms</li> </ul>
PROGRAMMED DELAY 0 TO 99999 ms	MEDIUM: $[9/f + 160 (ITF)]$ ms	WITHOUT HI-SPEED OPT	VALUE OR DELTA	ANY TWO: 10 ms ALL THREE: 12 ms
	SLOW: $[950 + 15/f]$ ms	(ITF < 1): 50 ms (ITF ≥ 1): 69 ms	6 to 10 ms	IF DISPLAY IS VALUE OR DELTA. ANY ONE: 2 ms ANY TWO: 4 ms ALL THREE: 6 ms

60061.0

Figure 3-8. Summary of the components of measurement time used by the 1689 Digibridge and an indication of how the time per measurement depends on measurement conditions and system selections. The START signal can be received via START button, IEEE-488 bus, or handler interface. The ACQ (otherwise known as ACQ OVER) and EOT signals are sent via the handler interface. Symbol "f" is test frequency in kHz and "ITF" is integration time or I- T factor. The 1689M requires less time than the 1689, particularly for calculation.

### 3.5.10 Measurement Time Summary

Figure 3-8.

To summarize the relationships of measurement time to a representative set of the many possible test conditions and operating selections, refer to Table 3-4 and the accompanying figure. Notice that the table applies to the 1689 Digibridge. Below the table are corrections that indicate about how much less time is required by the 1689M Digibridge.

Table 3-4  
1689 DIGIBRIDGE  
TYPICAL MEASUREMENT TIMES VS FREQUENCY AND MEASURE RATE

FOR DIGIBRIDGE WITH HIGH-SPEED MEASUREMENT OPTION																			
----- Measure Mode = Continuous * -----							----- Measure Mode = Triggered ** Note ***												
Display = BIN				Display = VALUE			Display = BIN				Display = VALUE								
Meas	Test	Freq (kHz)		Test	Freq (kHz)		Test	Freq (kHz)		Test	Freq (kHz)								
Rate	0.1	1	10	100	0.1	1	10	100	kHz:	0.1	1	10	100						
"Max"	115	42	36	35	123	50	44	43	ms	"Max"	185	49	37	35	193	57	45	43	ms
FAST	124	79	72	71	132	87	80	79	ms	FAST	194	86	73	71	202	94	81	79	ms
MED	133	205	189	185	141	213	197	193	ms	MED	233	215	190	185	241	223	198	193	ms
SLOW	958	960	950	915	966	968	958	923	ms	SLOW	1078	972	951	915	1086	980	959	923	ms

FOR DIGIBRIDGE WITHOUT HIGH-SPEED MEASUREMENT OPTION ****																			
----- Measure Mode = Continuous * -----							----- Measure Mode = Triggered ** -----												
Display = BIN				Display = VALUE			Display = BIN				Display = VALUE								
Meas	Test	Freq (kHz)		Test	Freq (kHz)		Test	Freq (kHz)		Test	Freq (kHz)								
Rate	0.1	1	10	100	0.1	1	10	100	kHz:	0.1	1	10	100						
"Max"	140	67	61	60	148	75	69	68	ms	"Max"	210	74	62	60	218	82	70	68	ms
FAST	159	114	107	106	167	122	115	114	ms	FAST	229	121	108	106	237	129	116	114	ms
MED	168	240	224	220	176	248	232	228	ms	MED	268	250	225	220	276	258	233	228	ms
SLOW	993	995	985	950	1001	1003	993	958	ms	SLOW	1113	1007	986	950	1121	1015	994	958	ms

- \* No entry for delay. When measure mode is CONTINUOUS, settling time is zero.
- \*\* No entry for delay. When measure mode is TRIGGERED, settling time is 7, 10, 12 ms/f defaults for measure rate = FAST, MED, SLOW, respectively; where f = test freq in kHz. Any programmed delay (can be 0 to 99999 ms) would replace the default settling time.
- \*\*\* Display of VALUE, delta% or deltaRLC requires 6 to 10 ms more than display of BIN.
- \*\*\*\* Omitting the high-speed measurement option adds about 38 ms normally, about 19 ms for "Max" rate (or any other condition in which IT factor is < 1) "Max" is defined as FAST rate with IT factor set to 0.25 (a special function).

----- FOR 1689M DIGIBRIDGE WITH HIGH-SPEED MEASUREMENT OPTION -----  
 Subtract about 10 ms from "Max" Meas Rate entries in corresponding 1689 table, above.  
 Subtract about 17 ms from other Meas Rate entries in corresponding 1689 table, above.

----- FOR 1689M DIGIBRIDGE WITHOUT HIGH-SPEED MEASUREMENT OPTION -----  
 Subtract about 17 ms from "Max" Meas Rate entries in corresponding 1689 table, above.  
 Subtract about 31 ms from other Meas Rate entries in corresponding 1689 table, above.

NOTE: Table 3-4 differs slightly from the table of typical measurement times given in the Specifications at the front of this manual (and data in paragraphs 3.5.1,3.5.2,3.5.5), although the tables are reasonably accurate. The differences underscore that these "typical" numbers are not specifications and that several test conditions and selections in addition to those stated for the tables affect measurement time. For example, selections of parameter and equivalent circuit affect calculation time.

### 3.6 ACCURACY, THE LIMITS OF ERRORS

#### 3.6.1 General

Refer to the Specifications, at the front of this manual. The specifications apply at an ambient temperature of 23 degrees C (unless recalibration has been done at some other temperature), in low humidity, if the OPEN and SHORT zeroing procedures have been executed properly (paragraph 3.1), and the quick-acquisition feature is NOT selected.

Typical accuracy is described below, for convenience in obtaining a birds-eye view of the way it relates to the principal test conditions, instrument programming, averaging, and median-value selection.

Refinement of the zeroing procedure to enhance accuracy for certain kinds of measurements is described in paragraphs 3.6.5 and 3.6.6. Cable-related errors and their correction are described in paragraph 3.6.7. Paragraph 3.6.8 describes the use of signal reversing (a special function) to enhance accuracy whenever test frequency is the same as power-line frequency.

#### 3.6.2 Accuracy for Some Typical Conditions

Figure 3-9.

For convenience in comparing the tradeoffs between speed and accuracy, the accuracy is tabulated in Table 3-5 for the same frequencies, and the results tabulated in the same arrangement, as the measurement-time tables. The data also appear as a graph of speed vs accuracy for several frequencies, in the accompanying figure.

Table 3-5  
ACCURACY FOR A SET OF CONDITIONS COMPARABLE TO THOSE IN PREVIOUS TABLE \*

Range 1 (Basic Range) **						Ranges 2, 3, 4 (Basic) ***					
Meas Rate	Test Freq (kHz)	0.1	1	10	100	Meas Rate	Test Freq (kHz)	0.1	1	10	100
"Max"		.27	.25	.40	xx %	"Max"		.27	.25	.28	.55 %
FAST		.14	.12	.27	xx %	FAST		.14	.12	.15	.43 %
MED		.07	.05	.20	xx %	MED		.07	.05	.08	.35 %
SLOW		.04	.02	.17	xx %	SLOW		.04	.02	.05	.32 %

\* With test voltage = 1 to 1.275 V, CONSTANT VOLTAGE indicator NOT lit, autoranging, RLC value within basic ranges (see below), and  $Q \ll 1$  with R,  $Q \gg 1$  with L,  $D \ll 1$  with C.

\*\* (R) 25.6 to 410 kilohm  
(L) 4.1/f to 65/f H  
(C) 400/f to 6400/f pF

\*\*\* (R) 6.25 ohms to 25.6 kilohm  
(L) 1/f mH to 4100/f mH  
(C) 6.4/f nF to 25/f uF

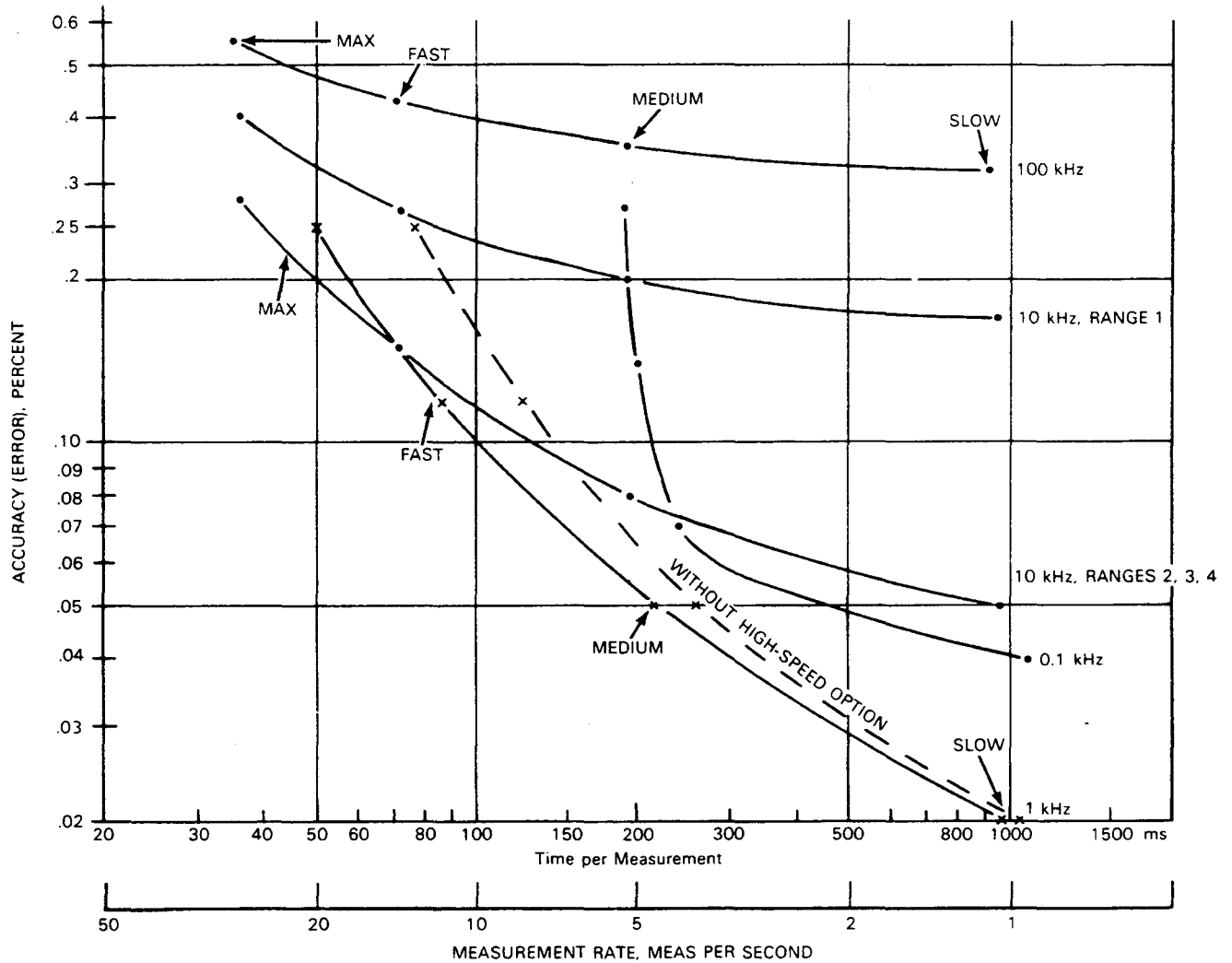

Figure 3-9. General view of the tradeoffs between measurement time and accuracy. Each curve shows the tradeoff for one test frequency. Operating points are labeled according to the selected measure rate (FAST, MEDIUM, SLOW). All of these curves apply to the following conditions: R, L, or C within basic ranges,  $D \ll 1$  or  $Q \gg 1$ , display is BIN NO., test voltage  $\Rightarrow 1.0$  V, constant voltage NOT selected, delay NOT programmed, measure mode is TRIGGERED, and the high-speed option is used (except for the dashed curve, which shows approximately the difference that this option makes). NOTE: for display of VALUE, add 6 to 10 ms to the time.

NOTE: The purpose of this graph is to show general tradeoffs. The curves were drawn from early 1689 Digibridge data; actual performance is generally better. The 1689M Digibridge is considerably faster, so that the three curves that are shown starting near 35 ms (for 1689) would start near 25 ms (if redrawn for 1689M).

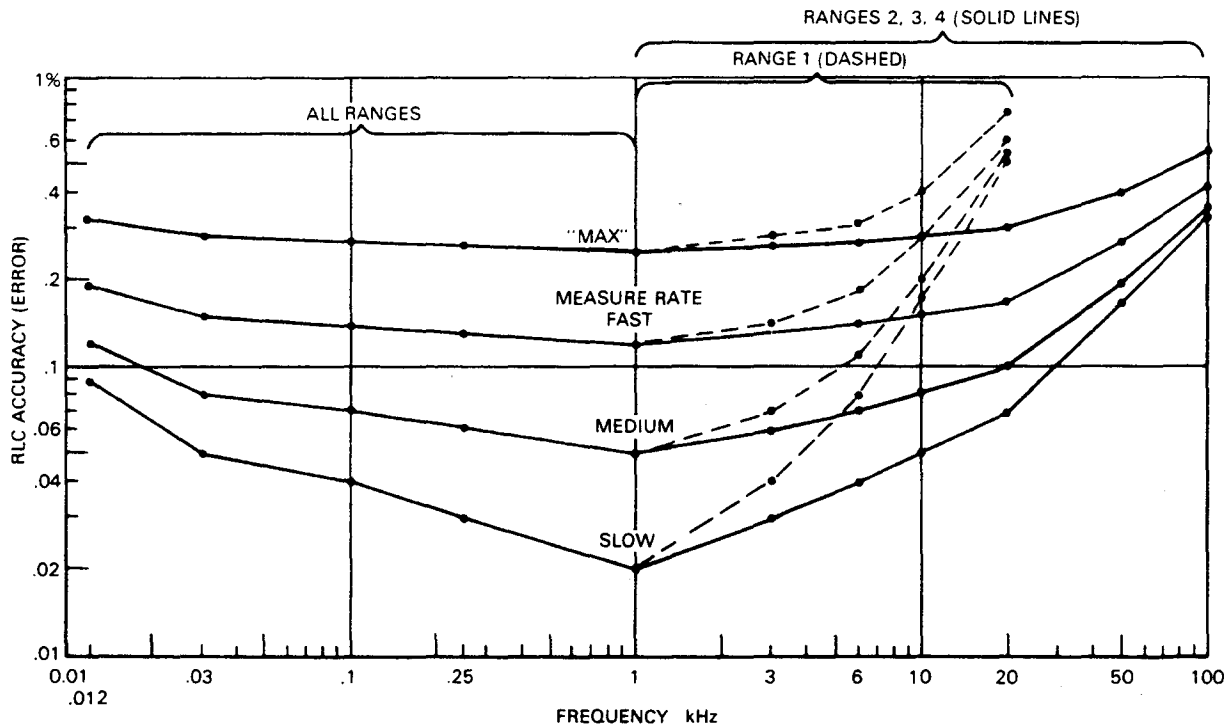

Figure 3-10. Approximate RLC accuracy vs test frequency for these test conditions: R, L, and C within basic range  $D < \text{lor } Q > > 1$ , test voltage  $\Rightarrow 1$  V, constant voltage NOT selected. The curves are labeled according to measure rate, SLOW, MEDnJM, and FAST; "Max" is FAST with integration-time factor set to 0.25 (a special function).

### 3.6.3 Averaging to Improve Accuracy

Figure 3-10.

The accuracy of measuring each DUT can be enhanced automatically by the Digibridge if you program it to make several measurements and average them before reporting the final result. Thus, errors due to electrical noise and other effects that are just as likely to make the measurement too high as too low are largely canceled. (This is true regardless of the display selection, VALUE, BIN NO., etc.) Of course, the time required to complete a measurement with averaging set to 10 (for example) is 10 times as long as the time for a single measurement.

Averaging can be set to any integer up to 255. To select 8 for example, select ENTER with the [FUNCTION] key, then press:

[8][=] [SHIFT] [AVERAGE]

Similarly, to inhibit averaging, select ENTER function and press:

[1][=] [SHIFT] [AVERAGE]

This is the default situation (no averaging).

Displays of averaged measurements depend on the measure mode.

1. If the measure mode is TRIGGERED, the display is repeatedly updated to be the running average, until the programmed number of measurements have been made; then the final average remains displayed until the next START command.
2. If the measure mode is CONTINUOUS, averaging proceeds without any change of display until the programmed number of measurements have been made; then the final average is displayed and remains until replaced by another final average.

### 3.6.4 Selection of Median Value for Better Accuracy

The Digibridge can be programmed to make measurements in one or more groups of three and take for results the median value in each group. If you also select averaging (of 5 for example), the median values of (5) groups will be averaged. Examples of uses for the median-value capability are given below.

If the "median-value" capability is enabled, the Digibridge makes three measurements, discards the highest and lowest results, and uses the median result for further calculations (if any), such as averaging. This capability is a special function. To enable it, press the following keys:

[1] [=] [SHIFT] [SPECIAL] [8]

To disable "median value", press: [0][=][SHIFT][SPECIAL][8]

An example of a use for the median value capability is to greatly reduce the likelihood of displaying an erroneous "transitory" measurement in CONTINUOUS measure mode. This erroneous measurement is typically caused by insertion or switching of the DUT at some indeterminate time during a measurement cycle. Typically, this erroneous measurement is preceded and followed by valid ones. (The next several measurements are correct until the DUT is changed again). If median value capability is enabled, the Digibridge displays the median of three measurements, only one of which is liable to be erroneous. Because the erroneous one is commonly quite different from the other two, the median is very likely to be one of the correct ones. Consequently, you see only one change in the value displayed, from "before" to "after" the DUT change.

Another example of a use for the median value capability is for measuring in the presence of occasional noise that pollutes some measurements ---particularly noise spikes or bursts that can occasionally be coupled from electrical equipment (through power line to Digibridge circuits or via inductive or capacitive coupling to the DUT itself). Such noise pollutes a measurement now and then, among a majority of measurements that are correct. This noise is non-random, i.e., not "white" noise, but it may be repetitive. Obviously you would prefer to have only the correct results displayed and/or output via the interfaces to other devices. If the duration of the noise spike is typically small compared to the length of a measurement cycle and the noise repetition rate is small compared to the Digibridge measurement rate, then it is likely that any polluted measurement will be one of three measurements in the median taking, the other two being valid and practically identical. The median of any three consecutive measurements is therefore very likely to be correct.

### 3.6.5 Accuracy Enhancement for Large or Small Impedances at Particular Frequencies

*Regular Zeroing at Test Frequency.* When measuring very large or small values of impedance, the Digibridge will provide much better accuracy than the specifications, *if* the OPEN and SHORT zeroing procedure has been recently repeated with test frequency set to the actual test condition.

Examples of the accuracy that is typically obtained with measure rate = SLOW, after using the actual test frequency when zeroing:

- At 30 Hz, R = 100 megohms +/- 1 % (range-1 extension, a factor of 240 over Rmax)
- At 120 Hz, C = 0.1 farad +/- 1% (range-4 extension, a factor of 480 over Cmax)
- At 10 kHz, C = 0.1 pF +/- 1% (range-1 extension, a factor of 400 below Cmin)
- At 100 kHz, L = 0.1 uH +/- 1% (range-4 extension, a factor of 100 below Lmin).

NOTES. Even better accuracy is possible if several measurements are averaged. See paragraph 3.6.3, above. Use of the "ratio display" special function is recommended when you measure very large values (which otherwise cannot be displayed) or very small values (for which ratio display can provide greatly improved resolution). See paragraph 3.3.7.

### 3.6.6 Accuracy Enhancement by Special Attention to Short-Circuit Inductance

The ratio display (paragraph 3.3.7) enables very high-resolution measurements of low inductance and high capacitance -even beyond the limits of normal RLC displays. If such measurements are planned, especially if the test frequency is high, the inductance of the "short circuit" used in the normal zeroing procedure should be considered.

The short circuit provided by a wire inserted into the Digibridge test fixture (paragraph 3.1.3) has an effective inductance in series with its very low resistance. This inductance typically has a magnitude of several nanohenries.

To enhance accuracy of measurements in which a few nanohenries of inductance are significant, use a properly chosen shape, size, and orientation of wire for the short circuit. For greatest accuracy, particularly for axial-lead DUTs, also correct the measured value by suitable calculation.

*Accuracy Enhancement Procedures.* Three methods are described. See Figure 3-11.

If measurements are to be made without any adaptors (radial-lead DUT), use a piece of no. 18 (AWG) wire, 2.2 cm long (7/8 in.), bent into a hair-pin shape as shown in "A". Press this wire fully down into the Digibridge test fixture, keeping the straight sides of the wire vertical. Measurement results now depend on the geometry of the DUT leads, but will typically contain a related error less than 10 nH. For even smaller error, correct inductance measurements by adding 5 nH to the displayed value.

If measurements are to be made with adaptors (axial-lead DUT), for most situations, make the shortcircuit calibration WITHOUT the adaptors. Use a piece of no. 18 (AWG) wire, 5 cm long (2 in.), bent into a rectangular shape as shown in "B". Press this wire fully down into the Digibridge test fixture, keeping the center of the wire above the center of the fixture and the straight sides of the wire vertical. Measurement results (with adaptors) will typically contain a related error of less than 5 nH, which can be verified by measuring a DUT consisting of a straight wire of known inductance --refer to one of the accompanying tables of inductances. (Wire length is measured between points of contact in the adaptors.)

If measurements are to be made with adaptors (axial-lead DUT), for greatest accuracy (requiring a manual calculation for every measurement), make the short-circuit calibration WITH adaptors spaced exactly as they will be for the DUT. Use any piece of straight wire having a known self inductance  $L_0$  --refer to Table 3-6. Measure the DUT using the series equivalent circuit. Then make the following calculation for each measurement.

$$\text{For an inductor: } L_s = L_m + L_0$$
$$\text{For a capacitor: } C_s = C_m / (1 - \omega^2 L_0 C_m) = \text{approximately } C_m ( + \omega^2 L_0 C_m)$$



where  $L_s$  and  $C_s$  are the corrected series values,  $l_m$  and  $C_m$  are the measured series values,  $w$  represents  $\omega = 2\pi$  times frequency, and  $l_0$  is defined above. (Refer to the specification: MIL-C-39010.)

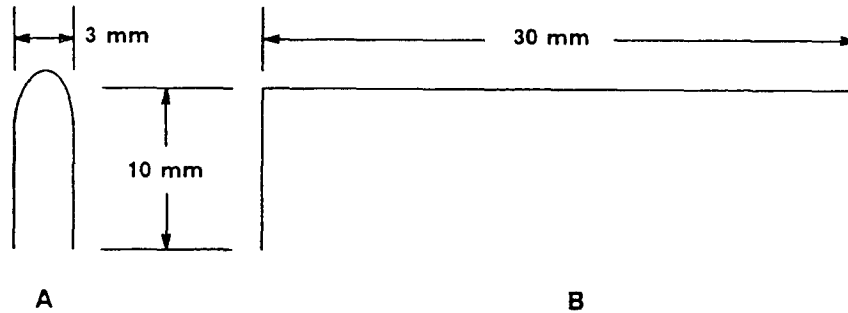

60051.0

Figure 3-11. Shapes of wire recommended for short-circuit zeroing procedures before critical low-impedance measurements. Use "A" for radial-lead or miscellaneous DUTs. Use "B" before installing adaptors for axial-lead DUTs.

Table 3-6  
INDUCTANCE OF STRAIGHT ROUND WIRES  
(Body of Table = Inductance in nH)\*

Wire Size	For frequency = 100 kHz								For low frequency							
	Wire Length in Centimeters								Wire Length in Centimeters							
	2	3	4	5	6	7	8	Delta	2	3	4	5	6	7	8	Delta
16	13.0	22.0	31.6	41.7	52.3	63.1	74.3	.13	13.5	22.7	32.6	42.9	53.7	64.8	76.2	.25
18	14.1	23.5	33.7	44.3	55.4	67.3	78.5	.16	14.4	24.1	34.4	45.2	56.4	68.1	79.9	.25
20	15.1	25.1	35.8	47.0	58.5	70.5	82.7	.19	15.4	25.5	36.3	47.6	59.3	71.3	83.6	.25
22	16.2	26.7	37.9	49.6	61.7	74.1	86.9	.22	16.3	26.9	38.1	49.9	62.1	74.6	87.3	.25

\* From the formula  $L = 2l[\log_n(2l/\rho) - 1 + \delta]$  nanohenries, where  $l$  = length (cm),  $\rho$  = radius (cm),  $\log_n$  = natural logarithm,  $\delta$  = skin-effect correction (tabulated). Reference: R. E. Terman, Radio Engineers' Handbook, McGraw Hill.

### 3.6.7 Cable-Related Errors and How to Correct for them

Test-fixture extension can introduce measurement error so that specified accuracy may not be met. In other words, some of the series impedances and ground capacitances associated with connecting a remote DUT can be large enough to introduce terms that add significantly to the error permitted by the accuracy specifications. In this paragraph, we discuss the cable-related sources of error, how to estimate it, and how to correct for it.

#### NOTE

We define the "normal DUT interface" here as the built-in test fixture of the 1689 Digibridge or the 1689-9600 or 1689-9605 remote test fixture attached via 1689-9602 BNC cable to the 1689M Digibridge.

The Digibridge automatically compensates for capacitance between "high" terminals and "low" in the zero calibration. Also the 5-terminal "Kelvin" circuitry is designed to minimize the effect of other cable and test fixture impedances on measurement accuracy. However, the following terms can be significant under some circumstances, particularly if a long extender cable is used to reach beyond the "normal DUT interface".

1. Acm, common-mode accuracy term, most significant on range 4.
2. Ald, capacitive-loading accuracy term, most significant on range 1, at high frequency.

Formulas and typical constants are given below for obtaining useful approximations to these terms.

*Common-Mode Accuracy Term. (Applies to any extension beyond instrument.)*

$$Acm = +/- [(0.05) (r + jx) / Z] \% \text{ of measured impedance}$$

where (r + jx) is the series impedance in the II lead including the cable, and Z is the DUT impedance. However, if you have selected SERIES EQUIV CKT, it is more useful to split Acm into the following 2 components, for treating Ls and Cs errors separately from Rs error:

$$Acmx = +/- [(0.05) (x) / (\text{DUT reactance})] \% \text{ of measured Ls or Cs}$$

$$Acmr = +/- [(0.05) (r) / (Rs)] \% \text{ of measured Rs.}$$

If either of these is significant, one can calculate and use it to correct each corresponding measured value. However, first make careful measurements with a known low-impedance DUT, to determine whether each correction should be positive or negative for your particular test fixture.

*Capacitive-Loading Error Term.*

$$Ald = [(0.003) (Krange) (f^2) (Csn / 1000 \text{ pF})] \% \text{ of principal measured value}$$

where Krange is: for range 1, 1; for range 2, .0625; for range 3, .0040; for range 4, .00024. Factor f is frequency in kilohertz. Csn is total capacitance from the low (IL and PL) terminals to ground (in cable and test fixture, beyond the "normal DUT interface" ---see notes above and below).

## NOTE

If the 1689-9603 tweezers (or other extension having capacitance of about 200 to 300 pF) is connected directly to the 1689M Digibridge (without any other cable) the difference from "normal DUT interface" is trivial, and Ald error is negligible.

If Ald is significant, one can calculate and use it to correct each measured C, L, or (if the DUT is a resistor) R. The effect on D or Q is negligible. For C, the Digibridge reads high; use a negative correction. For L or R, the Digibridge reads low; use a positive correction.

Refer to Table 3-7 for typical values to be used in the preceding formulas.

Refer to Table 3-8 for some representative examples of accuracy (error) terms related to cables, for certain range and frequency selections.

Notice that the addition of any unspecified cable and/or "homemade" remote test fixture will probably increase each of these parameters and error terms. Also, cable and test fixture capacitance can aggravate a resonance problem in measurement of large values of inductance at high frequency; refer to para 3.12.

Table 3-7  
TYPICAL PARAMETERS FOR DIGIBRIDGE EXTENDER CABLES

Cable	r (ohm)	Lc * (uH)	Csn (pF)
----- For 1689 -----			
1689-9603 (tweezers, with integral cable connected to 1689-9601 BNC adaptor at instrument)	.40	1.4	280
1689-9602 (BNC cable, with 1689-9601 BNC adaptor at instrument, and remote 1689-9600 test fixture)	.33	1.10	210
1657-9600 (plugs into instrument, remote banana plugs)	.036	1.10	475
1688-9600 (plugs into instrument, remote 874 connectors)	.019	0.45	155
----- For 1689M -----			
1689-9603 (tweezers, with integral cable connected directly to instrument)	.40	1.4	67
1689-9602 (BNC cable, with 1689-9600 or 1689-9605 remote test fixture)	.33	1.1	0
1657-9600 (with 1689-9602 BNC cable at instrument and 1689-9600/9605 fixture, has remote banana plugs)	.37	2.20	475
1688-9600 (with 1689-9602 BNC cable at instrument and 1689-9600/9605 fixture, has remote 874 connectors)	.35	1.55	155

\* The formulas for  $A_{cm}$  and  $A_{cmx}$  contain  $x$ , which is  $2(\pi)fL_c$ , where  $\pi$  is 3.1416, where  $f$  is expressed in Hz, and inductance  $L_c$  is tabulated above.

Table 3-8  
TYPICAL CABLE-RELATED ACCURACY (ERROR) TERMS

Accuracy Term*	----- Cable -----				Units
	1688-9600 (874)	1657-9600 (Banana)	1689-9602 (BNC/BNC)	1689-9603 (Tweezers)	
----- For 1689 -----					
Acmx for 1 kHz	.00014/Xdut	.00034/Xdut	.00034/Xdut	.00044/Xdut	% of Ls or Cs
Acmx for 20 kHz	.0028/Xdut	.0069/Xdut	.0069/Xdut	.0088/Xdut	% of Ls or Cs
Acmr (any freq)	.001/Rsdut	.002/Rsdut	.016/Rsdut	.020/Rsdut	% of measd Rs
Ald for con- ditions below **					
-----					
Range 1, 1 kHz	.00046	.0014	.00063	.00084	% of meas value
Range 1, 20 kHz	.19	.57	.25	.34	% of meas value
Range 2, 20 kHz	.012	.036	.016	.021	% of meas value
Range 2, 100kHz	.29	.90	.39	.52	% of meas value
Range 3, 20 kHz	.0007	.0023	.0010	.0013	% of meas value
----- For 1689M -----					
Acmx for 1 kHz	.00048/Xdut	.00069/Xdut	.00034/Xdut	.00044/Xdut	% of Ls or Cs
Acmx for 20 kHz	.0097/Xdut	.0069/Xdut	.0069/Xdut	.0088/Xdut	% of Ls or Cs
Acmr (any freq)	.0018/Rsdut	.002/Rsdut	.016/Rsdut	.020/Rsdut	% of measd Rs
Ald for con- ditions below **					
-----					
Range 1, 1 kHz	.00046	.0014	zero **	.00021	% of meas value
Range 1, 20 kHz	.19	.57	zero **	.084	% of meas value
Range 2, 20 kHz	.012	.036	zero **	.0052	% of meas value
Range 2, 100kHz	.29	.90	zero **	.13	% of meas value
Range 3, 20 kHz	.0007	.0023	zero **	.00033	% of meas value
-----					
* Xdut and Rsdut represent the DUT's series reactance and resistance, respectively					
** Ald error is significant only for extension beyond "normal DUT interface", where the system software applies compensation.					

### 3.6.8 Use of Signal Reversing (Special Function) for Tests at Power Frequencies

The special "signal reversing" function is primarily for use whenever the test frequency is 60 or 120 Hz (if your power frequency is 60 Hz) or whenever it is 50 or 100 Hz (if your power frequency is 50 Hz). However, it is also useful whenever the test frequency is equal to or very close to the frequency of any constant external signal that can be coupled to the low terminal(s) of the DUT (IL and PL).

If this disturbance is strong enough, it can degrade the accuracy of normal measurements. However, if the disturbance is not so very strong that the Digibridge sensing circuits are overdriven, then "signal reversing" will typically restore specified accuracy. This special function enables a test routine in which the phase of the test signal is periodically reversed and the Digibridge senses both phases additively. However, the constant-phase disturbance component of the sensed signal is canceled by subtraction. This capability is a special function. To enable it, press the following keys:

[1][=] [SHIFT] [SPECLAL] [3]

To disable "signal reversing", for fastest measurements, press:

[0][=] [SHIFT] [SPECLAL] [3]

### 3.7 BIAS FOR THE DUT

#### NOTE

Keep the E XTERNAL BIAS switch OFF and the BIAS ON indicator unlit, for all measurements of inductors and resistors, and also for capacitors unless they are to be measured with dc bias applied.

#### 3.7.1 Internal Bias

To measure capacitors with the internally available 2-volt dc bias voltage applied, use the following procedure. (The FUNCTION can be either MEASURE or ENTER.)

a. Press [SHIFT] [INT BIAS] keys so that the BIAS ON indicator is lit. NOTE: This indication, for internal bias, is somewhat dimmer than the other keyboard indicators.

b. The special shorting routine is recommended (see para 3.7.3); enable it as follows. Select ENTER function and then press:

[2] [=] [SHIFT] [SPECLAL] [3]      Select MEASURE function.

c. Wait at least 1 second before initiating measurement, to allow for settling of internal circuits. (In the CONTINUOUS mode, disregard displays for this interval.) This delay is associated with enabling the internal bias; it applies to each DUT only if internal bias is disabled for each change of DUT.

d. Observe correct polarity when inserting DUT into test fixture. Bias POSITIVE polarity is at the LEFT ("low" terminals) of the 1689 Digibridge built-in test fixture, as well as the remote test fixtures 1689-9600 and 1689-9605. Bias NEGATIVE polarity is at the RIGHT.

e. For each DUT, in the CONTINUOUS measure mode, disregard the first displayed result and read the second. Notice enough of the subsequent results to verify that the DUT has stabilized. Use the stable result.

f. In the TRIGGERED measure mode, each measurement cycle includes the normal settling time (7 to 12 ms for 1-kHz measurements), or a programmed delay. See paragraph 3.5.3. Remeasure enough DUTs to be sure that they are stabilized in the first measurement so that any subsequent differences are well within the error permitted by your needs. If not, program in a longer delay.

NOTE: There are two effects to be aware of in watching for stabilization of the DUT: voltage and capacitance. Besides charging to a "final" voltage, there is also the stabilization of capacitance value itself. For example, some aluminum electrolytic capacitors respond slowly to a change in applied voltage, therefore the DUT capacitance can be settling long after the voltage is essentially stable.

Normally, the delay for internal bias measurements should be about:

$$\text{Delay} = 10 \text{ Rstd Cx} \quad \text{seconds}$$

(If the internal bias is being switched off during each change of DUT --by remote control perhaps --this delay should be 1 second larger:  $1 + 10 \text{ Rstd Cx}$ .)

NOTE: Rstd is 102400 for range 1, 6400 for range 2, 400 for range 3, 25 for range 4. (See table in paragraph 3.4.2.) Cx is the capacitance of the DUT in farads.

For example, measuring 2000 pF at 1 kHz (range 1), this delay time should be about  $(10)(102400)(.000000002) = \text{approx } .002 \text{ seconds}$ . (Normal settling time is adequate.)

g. After biased measurements are completed, remember to disable the shorting routine, by selecting the ENTER function and pressing:

[0][=] [SHIFT] [SPECIAL] [3]

h. Remove internal bias by pressing the [SHIFT] [INT BIAS] keys, so that the BIAS ON indicator is NOT lit.

#### NOTE

The BIAS ON indicator serves to indicate whether internal bias is connected or disconnected *only if the EXTERNAL BIAS is switched OFF*. (See below for external bias.)

Notice that repeating the same keyboard sequence will cyclically enable and disable internal bias. For best results, after removing bias and before making further measurements, allow least 2 seconds for internal circuit discharge and settling.

### 3.7.2 External Bias

If bias is required at some other voltage than the 2- V internal bias, use external bias as described below.

Also:

**Be sure** that the voltage is never more than 60 V, max.

**A current limiting** voltage supply is recommended; set the limit at 200 mA, max.

**Be sure** that the bias supply is floating; DO NOT connect either lead to ground.

**Generally** the external circuit must include switching for both application of bias after each DUT is in the test fixture and discharge before it is removed.

**A well-filtered** supply is recommended. Bias-supply hum can affect some measurements, particularly if test frequency is the power frequency.

*Setup Procedure.*

- a. Connect the external bias voltage supply and switching circuit, using the 1658-2450 cable, supplied, via the rear-panel EXTERNAL BIAS connector. Observe polarity marking on the rear panel; connect the supply accordingly.
- b. Set the external supply to limit current ( $< 200$  mA).
- c. Set the external bias supply to the desired voltage ( $< 60$  V).
- d. If the Digibridge power is off, switch its POWER ON and wait for completion of the self-check routine before the next step.
- e. Switch the EXTERNAL BIAS ON (switch is at right of keyboard) and verify that the BIAS ON indicator is lit --see below. (If polarity is inverted, the indicator will not be lit as brightly as normal.)

If the bias cable fuse must be replaced, use a 200 mA fast-acting fuse.

- f. Switch the bias off using an external switch, so that the DUT can be inserted before bias is applied to it. Refer to the Operating Procedure below.

NOTE

The BIAS ON indicator serves to indicate *that the EXTERNAL BIAS is switched ON, NOT NECESSARILY the presence of external bias.* See below. Also: whenever the EXTERNAL BIAS switch is ON, the Digibridge automatically selects CONSTANT VOLTAGE.

*Indicator.* When the EXTERNAL BIAS switch is ON, the BIAS ON indicator shines as long as the Digibridge POWER is ON. (The indicator brightness depends somewhat on the external bias voltage.) Also, when the EXTERNAL BIAS switch is ON, but the POWER is switched OFF, this indicator is lit by external bias voltages above about 3 V.

*Effect on Power- Up.* Be sure that the EXTERNAL BIAS switch is OFF before you switch the Digibridge POWER ON. This is generally necessary to permit the power-up self checks to pass.

*Protection.* The Digibridge is internally protected from damage from charged capacitors with stored energy up to 1 joule at any voltage up to 60 V.

CAUTION

If your test procedure includes charging capacitors to higher energy or higher voltage before or during connection to the Digibridge, EXTERNAL PRECAUTIONS MUST BE TAKEN TO PROTECT THE INSTRUMENT.

*Operating Procedure.*

a. If TRIGGERED measure mode is to be used, calculate the delay that is suitable for the largest value capacitor in the group to be measured with external bias, thus:

$$\text{Delay} = (C_x V_{\text{bias}}) / I_{\text{max}} + 10 R_{\text{std}} C_x \quad \text{seconds}$$

NOTE:  $C_x$  is the capacitance of the DUT in farads.  $V_{\text{bias}}$  is the external bias voltage in volts.  $I_{\text{max}}$  is the maximum current from the external supply (usually 0.2) amperes.  $R_{\text{std}}$  is 102400 for range 1, 6400 for range 2, 400 for range 3, 25 for range 4. (See table in paragraph 3.4.2.)

If the calculated delay is greater than the normal settling time (7 to 12 ms for 1-kHz measurements), then program the Digibridge to use this delay. See paragraph 3.5.3.

b. The special shorting routine is recommended (see para 3.7.3); enable it as follows. Select ENTER function and press:

[2] [=] [SHIFT] [SPECIAL] [3]                      Select MEASURE function.

c. Observe correct polarity when inserting DUT into test fixture. Bias POSITIVE polarity is at the LEFT ("low" terminals) of the 1689 Digibridge built-in test fixture, as well as the remote test fixtures 1689-9600 and 1689-9605. Bias NEGATIVE polarity is at the RIGHT.

d. Use the external switches (user supplied) to remove bias from the test fixture, apply bias after the DUT is in place, remove bias after measurement, and short the DUT before its removal. A routine like this is generally recommended.

However, for occasional (non-production) measurements, if the capacitances being measured are less than 200 uF and the bias voltage less than 30 V, an optional procedure is to leave the external bias circuitry "on" during measurements and to use the Digibridge EXTERNAL BIAS switch to apply bias to the DUT (ON) and to remove it and discharge the DUT (OFF).

e. For each DUT, in the CONTINUOUS measure mode, disregard the first displayed result and read the second. Notice enough of the subsequent results to verify that the DUT has stabilized. Use the stable result.

f. In the TRIGGERED measure mode, each measurement cycle includes the normal settling time (7 to 12 ms for 1-kHz measurements), or a programmed delay. Remeasure enough DUTs to be sure that they are stabilized in the first measurement so that any subsequent differences are well within the error permitted by your needs. If not, program in a longer delay.

NOTE: There are two effects to be aware of in watching for stabilization of the DUT: voltage and capacitance. Besides charging to a "final" voltage, there is also the stabilization of capacitance value itself. For example, some aluminum electrolytic capacitors respond slowly to a change in applied voltage, therefore the DUT capacitance can be settling long after the voltage is essentially stable.

g. After biased measurements are completed, remove all bias by sliding the EXTERNAL BIAS switch OFF and if necessary pressing the [SHIFT][INT BIAS] keys, so that the BIAS ON indicator is NOT lit. Disable the shorting routine. (See below.)



### 3.7.3 Suppression of Transients

When measuring biased capacitors, the time required for settling of transients in the measuring circuitry can usually be reduced by selecting the automatic shorting routine (a special function), as follows. Select ENTER function and press:

[2][=] [SHIFT] [SPECIAL] [3]

However, if there is no bias, the normal routine is faster. To obtain it, select ENTER function and press:

[0] [=] [SHIFT] [SPECIAL] [3]

#### NOTE

This automatic shorting routine DOES NOT discharge the capacitor DUT. It does short a capacitance in the measurement circuit to help terminate the transient that results from connecting a DUT with bias.

## 3.8 BIN SORTING AND GO/NO-GO RESULTS

### 3.8.1 Introduction to Binning (Sorting Based on Limit Comparisons)

If a group of similar DUTs are to be measured, it is often convenient to use the limit-comparison capability of the Digibridge to categorize the parts. This can be done *in lieu of* or *in addition to* recording the measured value of each part. For example, the instrument can be used to sort a group of nominally 2.2-uF capacitors into bins of 2%, 5%, 10%, 20%, lossy rejects, and other rejects. Or it can assign DUTs to bins of (for example) a 5% series such as 1.8, 2.0, 2.2, 2.4, 2.7 uF, etc. The bin assignments can be displayed, for guidance in hand sorting, or (with an interface option) output automatically to a handler for mechanized sorting.

Up to 13 regular bins are provided for categories of the principal measurement (RLC), in addition to a bin for rejects in the secondary measurement (QDR), and a bin for all other rejects; total = 15 bins.

NOTE: The 1689-9620 high-speed measurement and IEEE/handler interface option provides a separate output signal line for each bin, suitable for connection to automatic handlers. However, the 1658-9620 IEEE/handler interface option provides only eight "go" bin output signal lines. Thus, an automatic handler can sort into bins 1 through 8. However, any assignments by the Digibridge into bins 9 through 13 are lumped with bin 14 (no-go), so far as the 1658-9620 handler interface is concerned.

Manually entered limits are normally entered in pairs (defining the upper and lower limits of a bin), in the form of nominal value and "percent" above and below that nominal. If only one "percent" value is entered for a bin, the limit pair is symmetrical (such as +/- 2%). To set up a non-symmetrical pair of limits, two "percent" values must be entered, the higher one first. Any overlapping portion of 2 bins is automatically assigned to the lower-numbered bin.

For simple GO/NO-GO testing, set up a QDR limit and one regular bin. Entry of limits in additional bins will define additional GO conditions. Be sure the unused bins are closed. (Bins 0 thru 13 are initially zero, at power-up. This means that the default QDR limit is "all fail" for D, Rs, and Q with R; it is "all pass" for Rp or Q with L; and that bins 1 through 13 are initially closed.)

The test frequency can be selected after limits are entered, before any particular measurement.

### 3.8.2 Sorting Methods

Figures 3-12, 3-13.

The figures illustrate 2 basic methods of sorting: nested and sequential. Nested limits are the natural choice for sorting by tolerance around a single nominal value. The lower numbered bins must be narrower than the higher numbered ones. Symmetrical limit pairs are shown; but unsymmetrical ones are possible. (For example, range AB could be assigned to bin 3 and range FG to bin 4 by use of unsymmetrical limit pairs in these bins.)

Sequential limits, on the other hand, are the natural choice for sorting by nominal value. Any overlap is assigned to the lower numbered bin; any gap between bins defaults to bin 14. The usual method of entry uses a redefined nominal value for each bin, with a symmetrical pair of limits. If it is necessary to define bins without overlap or gaps, use a single nominal value and unsymmetrical limit pairs. It is possible to set up one or more tighter-tolerance bins within each member of a sequence.

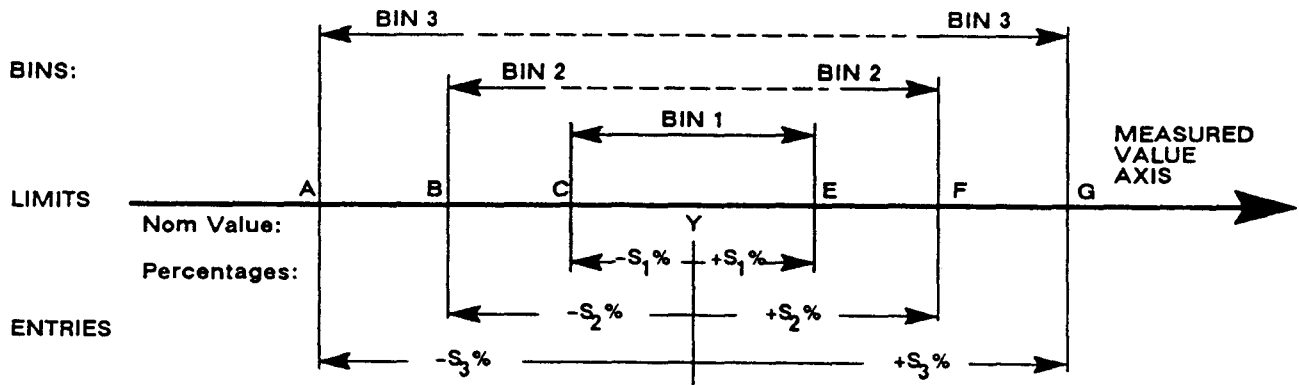

60035.0

Figure 3-12. Nested limits. A single nominal value Y is used and all limit pairs are symmetrical in this basic plan.

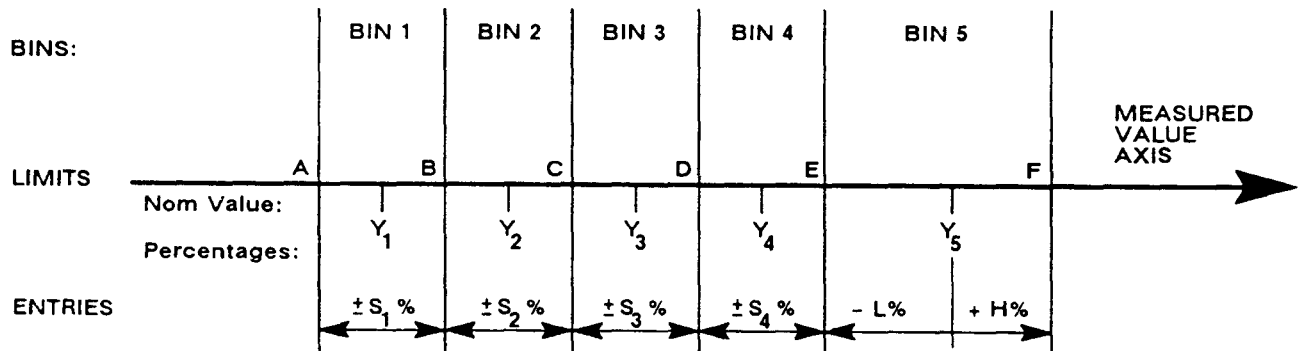

60036.0

Figure 3-13. Sequential limits. A different nominal value is entered for each bin and all limit pairs are symmetrical except for the unsymmetrical pair shown for example in bin 5.

Bucket sorting means sorting into bins that are not nested. The usual method is that mentioned above, sequential limits. However, there is no requirement that the bins be adjacent. Any of them can be defined with its own specific limits, which may be overlapping, adjacent, or isolated from any other bin.

### 3.8.3 Limit Entry Procedure

To enable comparisons (unless the keyboard is locked), first enter limits as follows. This procedure makes use of limit entry keys, (at the left of the [SHIFT] key), with gray (or yellow) labels that apply only when the selected FUNCTION is ENTER.

- a. Press [DISPLAY] key to select VALUE.  
Press [FUNCTION] key to select ENTER.

- b. To enter a single QDR limit (always bin 0): press the parameter key (such as [Cs/D]) appropriate to DUT. To change range and unit multipliers, press the same key repeatedly. (Refer to paragraph 3.3.4 for a table of units and multipliers, which indicates the sequence of multipliers that will appear.) Enter the maximum limit of D or Rs or Q with R; enter the minimum limit of Rp or Q with L, as follows. (Keyed numbers appear on the lefthand display). For example, to enter a Q limit of 85, press:

[8] [5] [=] [SHIFT] [BIN NO][0][0].

The value now moves to the right-hand display, confirming storage of the limit. Note: if you make a mistake, press the parameter key again and repeat the entry.

- c. To enter RLC limits for bins 1-13, three methods are given:

1. *Symmetrical percentage tolerances* (nested bins). Enter the nominal value of DUTs to be sorted. (The value appears on the RLC display. Units were selected in step b.) For example, to enter 123.40 as the nominal value, press:

[1] [2][3] [.] [4][=] [SHIFT] [NOM VAL].

Enter for bin 1 the narrowest percent tolerance to be sorted. As an example, for a tolerance of +/-0.2%: press

[.] [2][%] [=][SHIFT] [BIN NO][0][1].

The numerical limits for RLC are automatically computed and rounded-off values appear on the Digibridge displays (upper limit at the left, lower at the right).

For bin 2, enter the next wider tolerance, similarly. (Be sure to use 2 digits for the bin number.) Repeat the procedure for bins 3, 4, 5, ...up to a maximum of 13 bins.

2. *Various nominal values* (bucket sort). Plan for non-overlapping bins, each with a nominal value and limits defined by percent tolerance. For bin 1, enter nominal value and tolerance as described above. For each successive bin, similarly enter a new nominal value, then the tolerance and bin number. (Changing the nominal value does not affect limits already stored. Any DUT that qualifies for 2 overlapping bins will automatically be assigned to the lower bin.)

3. *Unsymmetrical tolerances*. To enter unsymmetrical limits, for example +2% -5% in bin 6: press:

[2][%][-][S][%][=][SHIFT][BIN NO] [0][6].

Two percentages of the same sign can be entered. Always enter the more positive tolerance first.

- d. You can close any bin that has been opened (as in steps b, c). For RLC bins, follow this example for bin 8: press:

[0] [=] [SHIFT] [BIN NO] [0] [8].

To disable QDR sorting, close bin 0 (using two digits for the bin number, as noted before); thus: for D or Rs or Q with R, press:

[9][9][9] [9] [=][SHIFT][BIN NO] [0][0];

However, for Rp or Q with L, press:

[0][=][SHIFT] [BIN NO] [0][0].

e. To enable GO/NO-GO lights after opening at least one bin, leave "nominal value" at any non-zero value. To disable GO/NO-GO and all bin sorting, press:

[0] [=] [SHIFT] [NOM VAL].

Note: To see the present numerical limits for bin 3 (for example), press:

[SHIFT] [BIN NO] [0][3]

and similarly, to see the nominal value, press:

[SHIFT] [NOM VAL].

This is the value that the Digibridge will use for a subsequent entry of bin limits, and (when function is changed to MEASURE and measurements are made) for calculation of delta %, delta RLC, etc.

**f. To measure a DUT with bin sorting:**

- Press the [FUNCTION] key to select MEASURE
- Press the [DISPLAY] key to select BIN NO.
- Insert the DUT.
- If the measure mode is TRIGGERED, press the START button.
- Observe GO/NO-GO and bin-number results. NO-GO indicates either QDR failure (bin 0) or RLC failure (bin 14). See also paragraph 3.1.4.

For continued operation of the Digibridge, in MEASURE function, using the limits entered as above, you can select any desired display, such as VALUE, or BIN No., with the [DISPLAY] key. (If you have the interface option, the available output data are not limited to the display selection.) The GO/NO-GO lights will operate unless you inhibit comparisons. (See below.)

### 3.8.4 Verification or Nominal and Limit Values

While the function is ENTER, the exact values entered into the Digibridge can be seen by either of 2 methods, as follows.

*During the Entry Process.* A confirming display is automatically provided immediately after the final keystroke of each entry step. For example, after the [NOM VALUE] keystroke, the entered value appears on the RLC display. After the [BIN NO] and number keystrokes, the actual limits of RLC value (not percentages) appear across the full display area: upper limit on the regular RLC display, lower limit (4 most significant digits) in the regular QDR display area. For bin 0, the QDR limit appears in the QDR area.

*Upon Demand.* To see the current "nominal value", depress the [NOM VALUE] key (while the ENTER indicator is lit). To see the limits in any particular bin (or to verify that it has been closed), depress [SHIFT][BIN NO] and the desired number, similarly. Displays selected in this way are limited by the units that are shown on the panel. For example, if the bin-3 limits are 162 and 198 nF, but the display units are pF, when you press [BIN No.] [0] [3], the display will go blank. Select either nF or uF (instead of pF) to obtain a display of these limits.

However, any "nominal values" previous to the current one are lost and cannot be displayed (unless entered again). Bin limits are not lost until replaced by new entries in the particular bin; but they are normally lost when POWER is switched OFF. To prevent loss, lock the keyboard; see paragraph 3.9.

For comments on how bin sorting information is displayed, see paragraph 3.3.3.

### 3.8.5 Examples of Limit Entry

*Nested Limits.* To enter a set of nested limits, operate the keyboard as described below for the example of inductors having  $Q > 21$ ,  $L_s = 33 \text{ mH} \pm 0.35\%$ ,  $\pm 1\%$ ,  $\pm 5\%$ ,  $+7 -9\%$ .

- a. With [FUNCTION] key, select ENTER.
- b. With [EQUIVALENT CIRCUIT] key, select SERIES.
- c. With parameter key [Ls/Q], select RLC units: mH.
- d. Enter Q limit thus: [2][1] [=][SHIFT] [BIN No.][0][0].
- e. Enter nominal RLC value: [3][3] [=][SHIFT] [NOM VALUE].
- f. Set bin 1 limits: [.] [3] [5] [%] [=][SHIFT][BIN No.] [0] [1].
- g. Set bin 2 limits: [1] [%] [=] [SHIFT] [BIN No.][0][2].
- h. Set bin 3 limits: [5] [%] [=] [SHIFT] [BIN No.][0][3].
- i. Set bin 4 limits: [7] [%] [-] [9] [%] [=] [SHIFT] [BIN No.] [0] [4].
- j. Close bin 5 (if open): [0] [%] [=] [SHIFT] [BIN No.][0][5].
- k. Close bins 6 through 13, similarly, if used before.

*Sequential Limits.* Sequential limits can be entered by either of the following methods; use the method that fits your application.

Method 1, changing the nominal value for each bin.

Advantage: Straightforward definition of each bin in terms of percentages of the bin's nominal value. Disadvantage: overlaps or gaps in coverage among several bins are not obvious.

(Remember that overlaps default to the lower-numbered bin; gaps default to bin 14.)

Example: For sorting capacitors into part of the standard 5% series, setting  $D < .005$ , and nominal values for the bins at  $C_s = 0.91, 1.0, 1.1, 1.2, 1.3 \text{ uF}$ .

- a. With [FUNCTION] key, select ENTER.
- b. With [EQUIVALENT CIRCUIT] key, select SERIES.
- c. With parameter key [Cs/D], select units: uF.
- d. Enter D limit: [.] [0] [0] [5] [=] [SHIFT] [BIN No.][0][0].
- e. Enter nominal C value: [.] [9] [1] [=] [SHIFT] [NOM VALUE].
- f. Set bin 1 limits: [5] [%] [=][SHIFT][BIN No.][0][1].
- g. Redefine nominal [1] [=] [SHIFT] [NOM VALUE].
- h. Set bin 2 limits: [5] [%] [=][SHIFT][BIN No.][0][2].
- i. Redefine nominal: [1] [.] [1] [=][SHIFT][NOM VALUE].
- j. Set bin 3 limits: [5] [%] [=][SHIFT][BIN No.][0][3].
- k. Redefine nominal: [1] [.] [2] [=][SHIFT][NOM VALUE].
- l. Set bin 4 limits: [5] [%] [=][SHIFT][BIN No.][0][4].
- m. Redefine nominal: [1] [.] [3] [=][SHIFT][NOM VALUE].

- n. Set bin 5 limits: [5][%][=] [SHIFT] [BIN No.][0][5].
- o. Close bin 6 (if open): [0] [%][=][SHIFT][BIN No.][0][6].
- p. Close bins 7 through 13, similarly (if used before).

NOTE: Because there are overlaps, bin numbers affect the binning (if a DUT satisfies two bins, it goes into "the lower-numbered bin"); for example, 1.046 uF will go into the 1.00uF bin (No.2) because it is numbered lower than the 1.1-uF bin (No.3).

Method 2, using one nominal value for the set of bins.

Advantage: All bin limits are related to the same nominal value, making it easy to define bins exactly adjacent to each other without overlaps or gaps. Disadvantage: Each bin is not readily defined in terms of its own nominal value. Example: For sorting capacitors into six adjacent "1%" bins from -3% to +3%, setting  $D < .005$ , and nominal value of the six bins at  $C_s = 1.0$  uF.

- a. With [FUNCTION] key, select ENTER.
- b. With [EQUIVALENT CIRCUIT] key, select SERIES.
- c. With parameter key [Cs/D], select units: uF.
- d. Enter D limit: [.] [0] [0] [5] [=] [SHIFT] [BIN No.] [0] [0].
- e. Enter nominal C value: [1] [=] [SHIFT] [NOM VALUE].
- f. Set bin 1 limits: [-] [2] [%] [-] [3] [%] [=] [SHIFT] [BIN No.] [0] [1].
- g. Set bin 2 limits: [-] [1] [%] [-] [2] [%] [=] [SHIFT] [BIN No.] [0] [2].
- h. Set bin 3 limits: [0] [%] [-] [1] [%] [=] [SHIFT] [BIN No.] [0] [3].
- i. Set bin 4 limits: [1] [%] [0] [%] [=] [SHIFT] [BIN No.] [0] [4].
- j. Set bin 5 limits: [2] [%] [1] [%] [=] [SHIFT] [BIN No.] [0] [5].
- k. Set bin 6 limits: [3] [%] [2] [%] [=] [SHIFT] [BIN No.] [0] [6].
- l. Close bin 7 (if open): [0] [%] [=] [SHIFT] [BIN No.] [0] [7].
- m. Close bins 8 through 13, similarly (if used before).

NOTE: For any bin the less negative or more positive percentage must be entered first as shown clearly in steps f and k. Because there are no overlaps, there will be no "default assignment to the lower-numbered bin". Binnumber sequence is immaterial.

### 3.8.6 Notes on Limit Entries in General

For additional detail, refer to the condensed instructions on the reference card under the Digibridge, and to the following notes.

*Frequency.* It is NOT necessary to select the test frequency first. Comparison results are valid even if the test frequency is changed later in the entry j measurement procedure.

*Bin 0.* The limit entered in bin 0 is always QDR. It is an upper or lower limit on the secondary measured value, depending on the parameter selection, as tabulated:

Rs/Q (upper)	Ls/Q (lower)	Cs/D (upper)	Cs/Rs (upper)
Rp/Q (upper)	Lp/Q (lower)	Cp/D (upper)	Cp/Rp (lower).

*Unsymmetrical Limit Pairs.* Enter 2 percentages for the bin. One or both may be + (unspecified sign) or -. Enter first the one that yields the larger absolute value of RLC.

*Unused Bins.* Initially, at power-up, bins 1 through 13 are closed so that unused ones can be ignored. Every unused bin that has previously been used (except 14) must be closed by entering 0%, as in the above examples. Once closed, it will stay closed until non-zero percent limits are inserted.

*Allowable Limits.* Max of 6 significant figures (example: 38.6719% or 999999%).

*Bin Order.* Optional except for nested bins; be sure the narrower limit pairs go into lower numbered bins (because all overlap goes to the lower numbered bin).

*Inhibiting Comparisons.* To inhibit all comparisons, set nominal value to zero. (Then GO/NO-GO indicators stay off.) Subsequent setting of nominal value to any number except zero enables all comparisons as previously set up. To inhibit QDR comparisons, set bin 0 to the "all-pass" extreme, i.e., to 0000 for Rp, or Q with L; to 9999 for D or Rs or Q with R.

## NOTE

When POWER is switched ON -if the keyboard is not locked -nominal value is initialized at zero. Therefore, all bin sorting is initially inhibited.

*Changing Entries.* Enter new value(s) --or a zero --to delete obsolete or erroneous nominal value or bin limits. Do not attempt to change or enter a single separate upper or lower limit in a bin, because any single percentage entered for a bin will be interpreted as a symmetrical pair of limits. Changing nominal value does not change any limits, but does determine the base for subsequent limit entries for specific bins. (After function is changed to MEASURE, this nominal value will also serve as reference for delta percent measurements.)

*RLC Unit Selection.* In limit entry procedures, it is NOT necessary to select the range that the Digibridge will use in measuring. Just be sure that the number you enter for nominal value is suited to the units and unit multiplier indicated on the display panel. For example, nominal values of .033 H, and 33 mH are equivalent.

### 3.8.7 Go/No-Go and Bin Assignment Results

If comparison (binning) is enabled, the GO /NO-GO indicators will provide the following information after each measurement:

GO ---The DUT passed, in bin 1,2, 3, ...13  
NO-GO ---The DUT failed, in bin 0 (QDR failure) or bin 14 (RLC failure).

If the display selection is BIN NO., the bin assignment will be shown in the left display area.

### 3.8.8 Bin Sum Information

If comparison (binning) is enabled, the Digibridge automatically keeps totals of the number of measurements assigned to each bin since power-up (or reset of the count to zero). The sums can be called up onto the display or sent out over the IEEE-488 bus. To make use of the bin-sum feature use these keystroke sequences.

```
{SHIFT} {BIN SUM} {0} {0} --- requests the sum for bin 0
{SHIFT} {BIN SUM} {0} {1} --- requests the sum for bin 1
{SHIFT} {BIN SUM} {0} {2} --- requests the sum for bin 2
(etc)                               Note: sum appears at left, bin number at right.
{SHIFT} {BIN SUM} {LOCK} --- sends the sums out via the IEEE-488 bus
{=} {SHIFT} {BIN SUM} {0} {0} {1} {4} --- resets all sums to zero
```

### 3.8.9 Binning and Ratio Measurement Simultaneously

In order to bin-sort component parts whose values lie beyond the normal measurement range of the Digibridge, you must combine ratio measurement (paragraph 3.3.7) with limit comparisons and binning (paragraph 3.8). You should first become familiar with both ratio measurement and binning procedures because the combined procedure (as follows) can be somewhat tricky. Just as the display is a dimensionless number in ratio measurement, so the limit comparisons are made on dimensionless ratios in this combined procedure.

Plan ahead so that you have in mind what the ratio display will be like for any given measurement. For entering bin limits, each nominal ratio is the ratio display that would be expected if a corresponding nominal-valued DUT were measured.

*General Procedure.*

- a. Select units appropriate for the component you plan to measure and a range that uses the largest unit multiplier. (This is necessary even if the measured value of the DUT is very small.) Select ENTER function.
- b. Enter the nominal ratio (see above) as the bin-limit "nominal value". Ignore units and multiplier (although those selected in step a will still be displayed); the number entered will be used by the Digibridge as a *ratio* reference.
- c. Enter (as usual) the desired set of tolerances for bin sorting. (If sequential limits are desired, also enter another nominal ratio, limits for other bins, etc.)
- d. If you plan to measure large-value components, make no change in range. (However, if you plan to measure small-valued components select a range that uses a small unit multiplier.)
- e. Enter the nominal value to be used by the Digibridge in the ratio calculations. Notice that units and multiplier are displayed. You can calculate what to enter as follows:

$$\frac{\text{expected typical measurement}}{\text{corresponding ratio to be displayed}} = \text{nominal value to be entered.}$$

- f. Enable ratio measurement (measured value / nominal) as usual. [NOTE: if you want the other ratio 'nominal/measured value' instead, then the calculation in step e has to be the product (expected meas)X(corresponding ratio).]
- g. Select MEASURE function and proceed with measurements. Display selections VALUE, delta%, and deltaRLC will all display the ratio; BIN NO. will display the bin assignment. With a few strokes of the [DISPLAY] key, it is easy to obtain both ratio and bin number for each DUT (even without using the handler or IEEE-488 interfaces).

*Example 1.* To sort 200-mF capacitors in bins of +/-5%, 10%, and 20%. Displays to be ratios that can be interpreted as Cp values in mF and dissipation factor D.

- a. Select PARALLEL equivalent circuit and ENTER function. Press [Cp/D]. Hold range 4 as follows.

[4] [=][SHIFT] [SPECIAL] [1]

- b. Set up nominal ratio to look like 200 mF:

[2][0][0] [=] [SHIFT] [NOM VAL]



c. Set up symmetrical bins as stated above:

[5][%] [=] [SHIFT] [BIN NO][0][1]  
[1] [0] [%] [=] [SHIFT] [BIN NO] [0][2]  
[2] [0][%] [=] [SHIFT] [BIN NO] [0] [3]

d. No action is required; range is correct.

e. Calculate  $(200\ 000\ \mu\text{F}) / (200) = 1000$  and press:

[1] [0][0] [0] [=] [SHIFT] [NOM VAL]

f. Enable the ratio mode (measurement/nominal) by pressing:

[2] [=] [SHIFT] [SPECIAL] [6]

g. Select MEASURE function and make measurements as usual. If you enable VALUE display, the ratio shown can be interpreted as value in mF, and the measured D is also displayed. If you enable BIN NO. display, the bin number only will be shown.

*Example 2.* To sort 1-milliohm resistors in bins of +/-1%,5%, and 10%. Displays to be ratios that can be interpreted as Rs values in milliohms (with better resolution than displays in ohms) and Q. NOTE: If the display resolution were not important, normal binning procedures would be sufficient; ratio measurement is not necessary for this binning.

a. Select SERIES equivalent circuit and ENTER function. Press [Rs/Q]. Hold range 1 as follows:

[1] [=][SHIFT] [SPECIAL] [1]

b. Set up nominal ratio to look like 1 milliohm:

[1] [=] [SHIFT] [NOM VAL]

c. Set up symmetrical bins as stated above:

[1][%][=] [SHIFT] [BIN NO][0][1] [5]  
[%] [=] [SHIFT] [BIN NO][0] [2]  
[1] [0][%] [=][SHIFT] [BIN NO][0][3]

d. Change from largest-value range to smallest-value range by pressing:

[4] [=][SHIFT] [SPECIAL] [1]

e. Calculate  $(.001\ \text{ohm}) / (1) = .001$  and press:

[.] [0][0][1] [=][SHIFT] [NOM VAL]

f. Enable the ratio mode (measurement/nominal) by pressing:

[2][=] [SHIFT] [SPECIAL] [6]

g. Select MEASURE function and make measurements as usual. If you enable VALUE display, the ratio shown can be interpreted as value in milliohms, and the measured Q is also displayed. If you enable BIN NO. display, the bin number only will be shown.

### **3.9 KEYBOARD LOCK, FUNCTION MAP, AND SUMMARY OF INTERROGATIONS**

#### **3.9.1 Keyboard Lock**

Locking the keyboard provides security against unintentional or unauthorized change in the keyboard selectable test conditions, as well as preserving them during the time that POWER is switched OFF.

Indications of the unlocked or locked state are as follows:

Unlocked --several keyboard indicators lit.

Locked --NO keyboard indicators lit,  
except possibly MEASURE, BIAS ON and/or REMOTE CONTROL.

To lock the keyboard, first select MEASURE function. Then, press the following keys *deliberately*. The command sequence is the same to lock and to unlock:

[1][6][8][9][=] [LOCK]

#### **NOTE**

If the REMOTE CONTROL indicator is lit, the keyboard may have been deactivated by remote command, in which case the way to reactivate it is by remote command. Refer to paragraph 3.12.

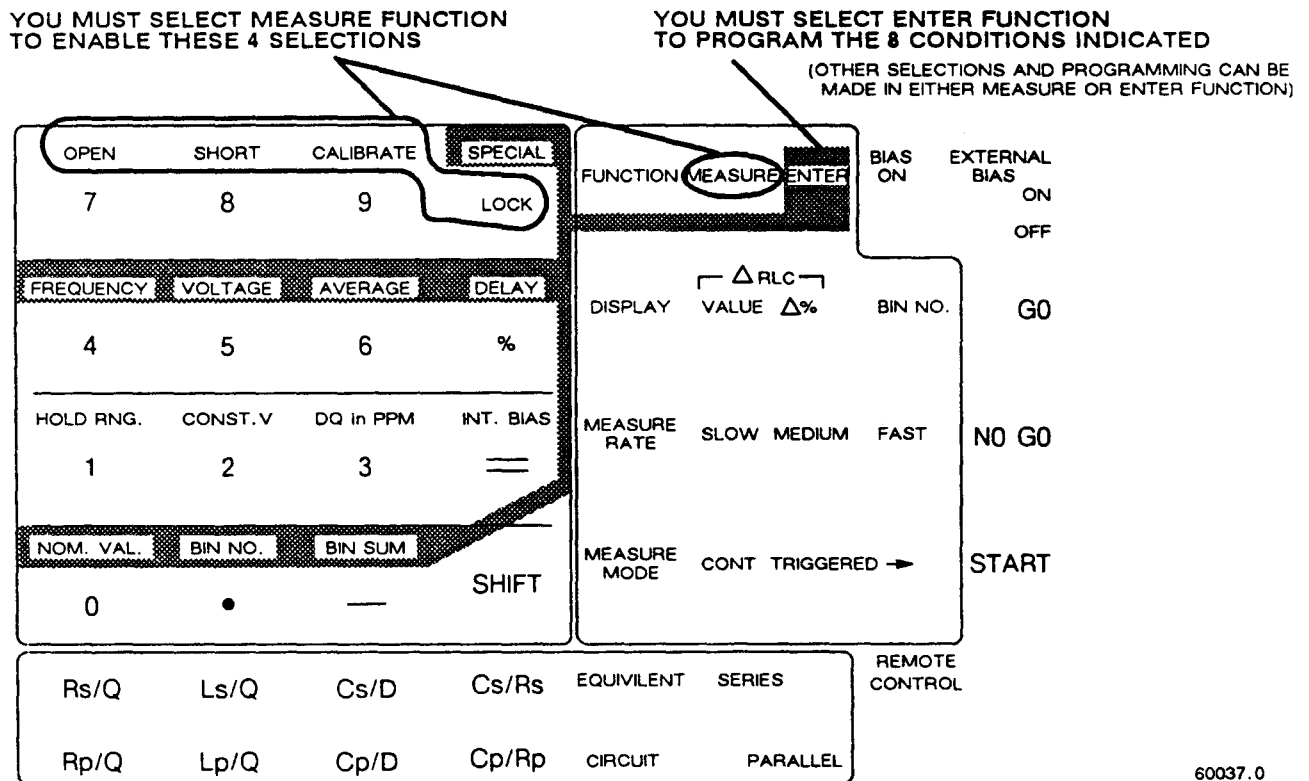

60037.0

Figure 3-14. Map of keyboard, showing which programming entries can be made in MEASURE function and which ones in ENTER function.

### 3.9.2 Function Map

Figure 3-14.

The figure shows graphically (like a map of the keyboard) which programming keys are enabled in the MEASURE function and which ones in the ENTER function. Notice that one row of keys inside the square 16-key area and all of the keys outside of that square are enabled *regardless* of any selection by the [FUNCTION] key.

### 3.9.3 Summary of Interrogations

Certain status (and results) information is indicated automatically on the display panels. For example:

Indicators below RLC display ---parameter and/or units of measurement.

All units and % indicators unlit --display is either bin no. or ratio.

NEG RLC --"negative" L or C; or (for displays of delta% or deltaRLC)

measured value less than stored nominal.

NEG QDR --capacitive resistor; or apparently negative loss factor. RANGE HELD ---

autoranging is disabled.

CONST VOLT --source resistance held to 25 ohms (accuracy compromised). DQ IN PPM ---

units of D or Q (not R) are parts per million.

Hardly any keyboard indicators lit, ---keyboard is locked.

Left display "0", right also "0", GO ---open-circuit zeroing enabled.

Left display "5", right also "5", GO ---short-circuit zeroing enabled.

Left display "6", right also "6", GO ---calibration enabled.  
Left display "0 14 ", right "blank" --measurement signal overload.  
Left display "22222", right "1111" ---convertor/detector malfunction.  
Left display "22222", right "2222" ---convertor/detector malfunction.

The preceding three lines are explained in paragraph 3.13. Indicators on the keyboard provide important information, NOT summarized here.

The following interrogations will work only if you select ENTER function:

[SHIFT] [NOM VAL] ---stored nominal value (appears displayed at left).  
[SHIFT] [BIN NO] [0] [1] --limits for bin 1 (both displayed, left and right).  
[SHIFT] [BIN NO][1][2] --limits for bin 12 (both displayed).  
[SHIFT] [BIN SUM] [0][3] ---count in bin (left); bin number (right).  
[SHIFT] [FREQUENCY] ---test frequency, kHz (displayed at left).  
[SHIFT][VOLTAGE] --test voltage that is applied behind source resistance.  
[SHIFT] [AVERAGE] --number of measurements (or medians) averaged per result. [SHIFT] [DELAY] ---milliseconds of delay after START before data is acquired.

The following special functions are explained more fully in paragraph 3.10. Each response display is: detail code at left and special-function number at right.

Interrogation	---Detail Code
[SHIFT] [SPECIAL] [1]	---present range number.
[SHIFT] [SPECIAL] [2]	---code for data output via IEEE-488 bus (para 3.10).
[SHIFT] [SPECIAL] [3]	---measurement routine (see paragraph 3.10).
[SHIFT] [SPECIAL] [4]	---number of digits blanked from left & right displays.
[SHIFT] [SPECIAL][5]	---integration time factor (normal: 1).
[SHIFT] [SPECIAL] [6]	---displays -meas/nom: 2, nom/meas: 1, normal: 0.
[SHIFT] [SPECIAL] [7]	---parameter selection --auto: 1, normal: 0.
[SHIFT] [SPECIAL] [8]	---if median of 3 meas taken: 1, normal: 0.
[SHIFT] [SPECIAL] [9]	---version number of Digibridge internal software.
[SHIFT] [SPECIAL] [0]	---ppm offset of source frequency from nominal.
[SHIFT] [SPECIAL] [.]	---IEEE Address (2 digits) when this option is installed.

The following interrogation will work only if you select MEASURE function:

[SHIFT] [SPECIAL] (hold key down) --all special functions

except 0, 1, and 9 (see above) that are NOT set to "0". For example, under default (power-up) conditions, the display is \*\*\*\* \*7\* (where \* represents "blank").

NOTE: special function 7 is initially set to 1; see Table 3-9. If you set special functions 2 through 8 each to 1, this display will be 2345 678. If you set these special functions each to 0, this display will be \*\*\*\* \* (blank).

### 3.10 SPECIAL FUNCTIONS

Most of the special functions are described in more detail in other parts of the manual. Refer to Table 3-9 for a brief summary of the special functions and how to operate the [SPECIAL] key. Programming of special functions can be done only in ENTER function.

Table 3-9  
SPECIAL FUNCTIONS

Purpose	Specific Selection	Keystrokes	Re Para
1. Setting the Range	Autorange (normal)	[0] [=] [SHIFT] [SPECIAL] [1]	3.5.6
	Hold range 1	[1] [=] [SHIFT] [SPECIAL] [1]	
	Hold range 2	[2] [=] [SHIFT] [SPECIAL] [1]	
	Hold range 3	[3] [=] [SHIFT] [SPECIAL] [1]	
	Hold range 4	[4] [=] [SHIFT] [SPECIAL] [1]	
2. Output via IEEE-488 Bus	No output (max meas speed)	[0] [=] [SHIFT] [SPECIAL] [2]	3.5.8
	Bin numbers only	[1] [=] [SHIFT] [SPECIAL] [2]	
	QDR results only	[2] [=] [SHIFT] [SPECIAL] [2]	
	QDR and bin numbers	[3] [=] [SHIFT] [SPECIAL] [2]	
	RLC results only	[4] [=] [SHIFT] [SPECIAL] [2]	
	RLC and bin numbers	[5] [=] [SHIFT] [SPECIAL] [2]	
	RLC and QDR results	[6] [=] [SHIFT] [SPECIAL] [2]	
	RLC, QDR, & bin numbers = full data	[7] [=] [SHIFT] [SPECIAL] [2]	
	No data on PASS, full data on FAIL	[8] [=] [SHIFT] [SPECIAL] [2]	
BIN no. on PASS, full data on FAIL	[9] [=] [SHIFT] [SPECIAL] [2]		
3. Special Measurement Routines	Normal	[0] [=] [SHIFT] [SPECIAL] [3]	3.6.8
	Signal reversing (useful when test frequency coincides with power frequency)	[1] [=] [SHIFT] [SPECIAL] [3]	
	Shorting in measurement circuit (useful when measuring biased capacitors)	[2] [=] [SHIFT] [SPECIAL] [3]	3.7.3
	Both reversing and shorting	[3] [=] [SHIFT] [SPECIAL] [3]	4.2.4
	Quick acquisition meas routine (MED and FAST only; useful at low frequencies)	[4] [=] [SHIFT] [SPECIAL] [3]	
	Quick acquisition <i>and</i> shorting (MED and FAST only; useful at low frequencies)	[5] [=] [SHIFT] [SPECIAL] [3]	

(continued on next page)

Table 3-9 (continued)  
SPECIAL FUNCTIONS

Purpose	Specific Selection	Keystrokes	Re Para
4. Digit Blanking	Elimination of "a" digits from RLC display and "b" digits from QDR display	[a] [. ] [b] [=] [SHIFT] [SPECIAL] [4]	
5. Integration-Time Factor	Multiplies integration time by factor f (0.25 to 6), normally 1. Reducing f decreases accuracy and reduces measurement time. Increasing f does the converse.	[f] [=] [SHIFT] [SPECIAL] [5]	3.5.5
6. Ratio Displays (RLC only)	Normal displays Ratio displayed: nominal/meas value meas value/nominal	[0] [=] [SHIFT] [SPECIAL] [6] [1] [=] [SHIFT] [SPECIAL] [6] [2] [=] [SHIFT] [SPECIAL] [6]	3.3.7
7. Man/auto Parameter Selection;	Manual selection of parameter Automatic selection of parameter (R/Q, L/Q, or C/D); default	[0] [=] [SHIFT] [SPECIAL] [7] [1] [=] [SHIFT] [SPECIAL] [7]	3.3.1
Reset	Reset all selections to default (power-up) conditions.	[2] [=] [SHIFT] [SPECIAL] [7]	Note*
8. Median Result	Normal, no median found Display is median of 3 meas	[0] [=] [SHIFT] [SPECIAL] [8] [1] [=] [SHIFT] [SPECIAL] [8]	3.6.4
9. Version	Displays the software version	[SHIFT] [SPECIAL] [9]	
10. Frequency Correction	Displays the correction "c" Refer to paragraph 3.4.1	[SHIFT] [SPECIAL] [0]	3.4.1
11. IEEE Address	Displays the LISTEN address of the optional interface board.	[SHIFT] [SPECIAL] [. ]	

NOTE

Resetting all choices to power-up (default) selections quickly establishes known operating conditions suitable for routine operation (paragraph 3.1.4) or for making any further selections. Refer to a note about command P2, near the end of paragraph 3.12.3.

### 3.11 OPERATION WITH A HANDLER

If you have the interface option and have made the system connections to a handler (paragraph 2.7), the Digibridge operating procedure is as follows.

a. Set up the handler either of two ways: indexing on EOT or indexing on ACQ, as explained below. The handler must supply a signal (here called "start next measurement") when it has completed connection of the DUT.

*Indexing on EDT.* Set up the handler to respond to the EOT signal from the Digibridge, which occurs at the "end of test", when the bin assignment is available for sorting. Set up the Digibridge to receive its START signal from the handler's "start next measurement" signal. This setup is simpler than the one below.

*Indexing on ACQ.* Set up the handler to respond to the ACQ signal from the Digibridge, which occurs after the "data acquisition" is complete. The handler can then remove the DUT from the test fixture and replace it with another DUT, while the Digibridge is calculating the result. In addition, set up an interface that provides a START signal to the Digibridge by logical combination of the EOT signal from the Digibridge AND the "start next measurement" signal from the handler. Indexing on ACQ results in higher measurement rate than indexing on EOT.

b. Program the Digibridge for binning, as described in paragraph 3.8. The 1689-9620 High-Speed Measurement Option includes the capability to sort automatically into all of the bins. However, with the 1658-9620 IEEE-488 Bus / Handler Interface Card, leave bins 9 through 13 closed because this handler interface lumps all five of them with bin 14, as explained in paragraph 3.8.1.

NOTE: Be sure to leave a non-zero number as "nominal value" in the Digibridge memory, to enable the GO/NO-GO indicators and the EOT signal.

c. If measured values are not needed, select BIN NO. with the [DISPLAY] key. This selection saves 6 to 10 ms for each measurement, compared to other displays. However, if measured values are to be monitored visually, select VALUE with the [DISPLAY] key, or select the desired "delta" display. If the secondary measurement is D or Q, select DQ IN PPM or normal DQ. The displays are useful for incidental monitoring of measurements while the handler automatically sorts the parts being processed.

d. If the normal settling time is insufficient for transients (or if a shorter delay is appropriate), program the desired delay, as explained in paragraph 3.5.3.

e. Select MEASURE function and TRIGGERED mode. This mode (together with suitable settling time or delay) minimizes the time between insertion of the DUT into the test fixture and beginning of a valid measurement. Measurement starts when the Digibridge receives the START signal from the handler (or when the START button is pressed).

f. Select other measurement conditions as desired: EQUIVALENT CIRCUIT, RANGE HELD or autorange, MEASURE RATE, test FREQUENCY, test VOLTAGE, CONSTANT VOLTAGE or normal voltage, AVERAGE or regular, etc.

g. Select any desired special function (output of results via IEEE-488 bus, special routines, median result, etc -- refer to paragraph 3.10). Enabling IEEE-488 output adds several milliseconds of calculation time to each measurement cycle: about 2 to 12 ms depending on the type of data. The presence of the high-speed measurement interface option subtracts about 35 ms from the same calculation time. Median calculation requires somewhat less than three times as long as normal measurements. For measurement time considerations, refer to paragraph 3.5.

### 3.12 DATA OUTPUT AND/OR PROGRAMMING VIA IEEE-488 BUS

These considerations apply only if you have an interface option. (If you do, there will be interface connectors at the rear. See Figure 1-3.) The two interface options are interchangeable in the basic IEEE-488-bus function. However, the 1689-9620 high-speed option is faster in making measurements than the 1658-9620; and the 1689-9620 provides handler-interface outputs for 15 bins, whereas the 1658-9620 provides them for 10 bins.

#### 3.12.1 IEEE-488 Interface Unused

If there is no system connection to the IEEE-488 INTERFACE connector, be sure to keep the TALK switch set to TALK ONLY.

#### 3.12.2 Talk-Only Use, for Data Output

This pertains to a relatively simple system, with the Digibridge outputting data to one or more "listen only" (IEEE-488 compatible) devices such as a printer.

a. Set the TALK switch to TALK ONLY.

b. Program the Digibridge to send out results automatically after each measurement. (Refer to paragraph 3.10.) The "special" commands for this purpose can be executed only in ENTER function, as follows.

[ 1 ]	[ = ]	[ SHIFT ]	[ SPECIAL ]	[ 2 ]	( for bin numbers )
[ 2 ]	[ = ]	[ SHIFT ]	[ SPECIAL ]	[ 2 ]	( for QDR )
[ 3 ]	[ = ]	[ SHIFT ]	[ SPECIAL ]	[ 2 ]	( for QDR and bin numbers )
[ 4 ]	[ = ]	[ SHIFT ]	[ SPECIAL ]	[ 2 ]	( for RLC )
[ 5 ]	[ = ]	[ SHIFT ]	[ SPECIAL ]	[ 2 ]	( for RLC and bin numbers )
[ 6 ]	[ = ]	[ SHIFT ]	[ SPECIAL ]	[ 2 ]	( for RLC and QDR )
[ 7 ]	[ = ]	[ SHIFT ]	[ SPECIAL ]	[ 2 ]	( for RLC, QDR, and bin numbers )
[ 8 ]	[ = ]	[ SHIFT ]	[ SPECIAL ]	[ 2 ]	( no output on PASS, full data set on FAIL )
[ 9 ]	[ = ]	[ SHIFT ]	[ SPECIAL ]	[ 2 ]	( BIN data on PASS, full data set on FAIL )
[ 0 ]	[ = ]	[ SHIFT ]	[ SPECIAL ]	[ 2 ]	( for no data output via IEEE-488 bus )

Operate the Digibridge in the usual way (manually). The system may constrain operation in some way. For example, a slow printer will limit the measurement rate because it requires a certain time to print one value before it can accept the next.

Refer to Table 3-10 for examples of the interface message code for data transfer. This table shows typical codes, but does not repeat the entire ASCII code. (There is a more complete table, in paragraph 2.8.)

*Output Formats for RLC, QDR, and BIN NO. Results.* Refer to Tables 3-11 through 3-13 for the formats of the output data: RLC, QDR, bin number (for the most recent measurement). If output of results has been enabled, by special function 2 as described above (or X1... X9 command; see paragraph 3.12.3, Table 3-17), the Digibridge sends data to the IEEE bus at the completion of each measurement sequence. The character string for RLC value has the length of 17 characters; for QDR value, 17 characters; for BIN NUMBER, 10 characters, including spaces, carriage return, and line feed characters.



NOTE

For a description of the compacted binary data output format (which saves time), refer to paragraph 3.12.4.

**Table 3-10**  
**ABBREVIATED INTERFACE MESSAGE CODE FOR "TALK-ONLY" DATA TRANSFER**

Character (ASCII)	Decimal Equiv	DI08	DI07	DI06	DI05	DI04	DI03	DI02	DI01
A	65	0	1	0	0	0	0	0	1
B	66	0	1	0	0	0	0	1	0
C	67	0	1	0	0	0	0	1	1
	-----		etc		-----				
1	49	0	0	1	1	0	0	0	1
2	50	0	0	1	1	0	0	1	0
3	51	0	0	1	1	0	0	1	1
	-----		etc		-----				

-FOOTNOTES FOR TABLE 3-11 -

\* Underrange generally occurs when the measured impedance is lower than the normal low limit (for automatic range change) and there is a lower-impedance range. Overrange generally occurs when the measured impedance is higher than the normal high limit (for automatic range change) and there is a higher-impedance range. In either case, an appropriate range change will improve accuracy. If there is no appropriate range to change to, the status is "range end extension"; see below. Range limits are different if CONSTANT VOLTAGE has been selected; see paragraph 3.5.6.

\*\* Range 1 end extension if DUT impedance exceeds that of the largest R or L (smallest C) in basic range 1. Range 4 end extension if DUT impedance is less than that of the smallest R or L (largest C) in basic range 4. No possibility of changing range to improve accuracy.

\*\*\* If the measurement is outside of the display range (display goes blank), 9999999 is output in this numeric field.

Table 3-11  
DATA OUTPUT FORMAT FOR RLC VALUE,  $\Delta\%$ ,  $\Delta\text{RLC}$ , OR RATIO

Character Sequence	Purpose	Allowed Characters	Meaning
1	Status	(space) U O E I	Normal operation, measurement on a basic range Underrange held (reduced accuracy)* Overrange held (reduced accuracy)* End extension of range 1 or 4 (reduced accuracy)** Invalid measurement due to signal overload
2	Value or $\Delta\text{RLC}$ or ratio	(space) ^ /	Normal display $\Delta\text{RLC}$ Mode Ratio Mode: Nominal Value/RLC Value
3	Parameter	L C R	Inductance Capacitance Resistance
4	Normal or ratio mode	(space) /	Normal mode (one of 3 described above) Ratio Mode: RLC Value/Nominal Value
5,6	Units	(space)H mH uF nF pF (space)% (space)O kO	Henries Millihenries Microfarads Nanofarads Picofarads Percent difference from nominal value Ohms Kilohms
7	Format	(space)	
8	Sign	(space) -	Positive R,L,C, $\Delta\%$ , or $\Delta\text{RLC}$ Negative R,L,C, $\Delta\%$ , or $\Delta\text{RLC}$
9...15	Number	012345 6789. (space)	Measured number, right justified in format field; like the RLC display except the zero before the decimal point is explicitly provided and this number can be as long as seven characters. ***
16		(CR)	The standard "carriage return" and "line feed" characters; end of string.
17	Delimiter	(LF)	

-----  
\* \*\* \*\*\* Footnotes: see preceding page.

Table 3-12  
QDR-VALUE DATA OUTPUT FORMAT

Character Sequence	Purpose	Allowed Characters	Meaning
1	Status	(space) 0 I	Normal operation Ovrange of QDR display Invalid measurement due to signal overload
2	Format	(space)	
3	Parameter	Q D R	Quality factor Dissipation factor Resistance
4	Format	(space)	
5...7	Units	(2 spaces)O (space)kO ppm (3 spaces)	Ohms Kilohms Parts per million (for D or Q) Dimensionless (for Q or D)
8	Sign	(space) -	Positive QDR value Negative QDR value
9....15	Number	012345 6789. (space)	Measured number, right justified in format field; like the QDR display except the zero before the decimal point is explicitly provided and this number can be as long as six characters. *
16	Delimiter	(CR)	The standard "carriage return" and "line feed" characters; end of string.
17		(LF)	

\* If measurement is overrange (display goes blank), 999999 is output in this field.

Table 3-13  
BIN-NUMBER DATA OUTPUT FORMAT

Character Sequence	Purpose	Allowed Characters	Meaning
1	Pass/fail	(space) F	Go (bins 01 through 13) No-Go (bins 00 or 14)
2	Format	(space)	
3	Label	B	The word "BIN".
4		I	
5		N	
6	Format	(space)	
7,8	Bin number	01234 56789	Bin number assignment, 00 to 14.
9	Delimiter	(CR)	The standard "carriage return" and "line feed" characters; end of string.
10		(LF)	

Table 3-14  
BIN SUMMARY DATA OUTPUT FORMAT

Character Sequence	Purpose	Allowed Characters	Meaning
1	Pass/fail	(space) F	Go (bins 01 through 13) No-Go (bins 00 or 14)
2	Format	(space)	
3	Label	B	The word "BINSUM".
4		I	
5		N	
6		S	
7		U	
8		M	
9	Format	(space)	
10,11	Bin number	01234 56789	Bin Summary Number, 00 to 14.
12	Equivalence	=	Equals
13-17	Sum	01234 56789	Total number counted in this bin, the bin-summary number.
18	Delimiter	(CR)	The standard "carriage return" and "line feed" characters; end of string.
19		(LF)	

*Bin Summary Output Format, Table 9-14.* The bin summary output can be enabled by the [SHIFT][BIN SUM][LOCK] sequence from the keyboard. (It can also be enabled by the EI command from the bus. See paragraph 3.12.3.) The bin summary output consists of 15 lines, one apiece for the 15 bins (00 through 14). Each line has the format shown in the table.

### 3.12.3 Talk/Listen Use, for Remote Programming and Data Transfers

Observe the REMOTE CONTROL indicator light. If it is lit, there is no opportunity for manual operation (except switching EXTERNAL BIAS ON and OFF and use of the START button if manual start is enabled.) The displays may be observed then, but their content is controlled by the system controller, via the IEEE-488 bus.

Details of test program preparation are beyond the scope of this manual. Refer to Table 3-18 for an example of message activity during a control sequence in which the controller says "start" and the Digibridge (after a measurement) says "C uF 1.2345".

*Programming Guidelines.* If the Digibridge is to be programmed (TALK switch set to TALK/LISTEN), keep the following suggestions in mind.

1. An "unlisten" command is required before measurement is possible.
2. If not addressed to talk, the Digibridge sends a service request (SRQ low) when it has data ready to send.
3. Then SRQ will not go false (high) until the Digibridge has been addressed to talk or has been serially polled. A typical program might include these features:

**Initial Setup:** with ATN true, "untalk unlisten, my listen address (of Digibridge), my talk address (of CPU)"; then with ATN false, measurement conditions.

**Measurement Enabling Sequence,** for example: untalk the Digibridge, send a GET, unlisten the Digibridge.

**After** the CPU receives the SRQ, necessary enabling of data transfer: with ATN true, "untalk, unlisten, my listen address (of CPU), my talk address (of Digibridge)"; then ATN false .

*Serial Poll --Status Byte --Table 3-16.* When the bus is in the serial poll mode and the Digibridge is addressed to talk, the Digibridge responds with a status byte, which is encoded as shown in the table and sent on the data lines DI01 through DI08.

Table 3-15  
INTERFACE MESSAGE CODE FOR REMOTE CONTROL

Message code*	Note **	ASCII Equiv	Decimal Equiv***	Sent concurrently with ATN line true:							
				DI08	DI07	DI06	DI05	DI04	DI03	DI02	DI01
MLA	Set	#	35	X	0	1	0	0	0	1	1
	Tot	(SP) to >	32 to 62	X	0	1	<MSB--device-address--LSB>				
MTA	Set	C	67	X	1	0	0	0	0	1	1
	Tot	@ to ^	64 to 94	X	1	0	<MSB--device-address--LSB>				
SPD	--	(EM)	25	X	0	0	1	1	0	0	1
SPE	--	(CAN)	24	X	0	0	1	1	0	0	0
UNL	--	?	63	X	0	1	1	1	1	1	1
UNT	--	--	95	X	1	0	1	1	1	1	1

Because the following messages are addressed commands, they will affect the Digibridge operation only while it is addressed to listen.\*\*\*\*

GET	--	(BS)	8	X	0	0	0	1	0	0	0
GTL	--	(SOH)	1	X	0	0	0	0	0	0	1

.Mnemonic key to codes: MLA = my listen address; MTA = my talk address; SPD = serial poll disable; SPE = serial poll enable; UNL = unlisten;  
UNT = untalk; GET = group execute trigger; GTL = go to local.

..Set = address setting as supplied by factory. Tot = total range of choice.  
See paragraph 2.8 for address changing procedure.

...Decimal equivalent makes DI08 (which is immaterial) a zero. Logical 1 is low state (true), logical 0 is high state.

.....Digibridge is addressed to listen by MLA message containing its device address (see para 2.8). It terminates this condition when it receives UNL command, which is necessary before it can make measurements or recognize its own keyboard.

Table 3-16  
STATUS CODE

Line	Significance of a "1" (Low)	Significance of a "0" (High)
DI08	Remote.	Local.
DI07	Request for service, RQS. (This device asserted SRQ.)	No request by this Digibridge for service.
DI06	Recalibration required.	Normal operation.
DI05	Busy, measurement in process.	Measurement completed.
DI04	Limits were tested.	Limits were not tested.
DI03	RLC measured value is available.	RLC value is not available.
DI02	QDR measured value is available.	QDR value is not available.
DI01	Bin No. assignment is available.	Bin No. assignment is not available.

*Instrument Program Commands.* The set of commands used in remote programming is an input data code to which the instrument will respond as a "talker/listener", after being put into a remote-control mode via the bus (see Table 3-15) and addressed to listen to device-dependent command strings.

Refer to Table 3-17. The programming command set includes all of the keyboard functions except switching external bias ON/OFF and full recalibration, which are not remotely programmable. Keyboard functions are explained above, particularly in paragraphs 3.3, 3.4, 3.8, 3.9, 3.10; and most of these commands are related to them in an obvious way.

Zero calibration by remote control is similar to the manual procedure. The "Z1" command is equivalent to manually keying

[I][6][8][9][=][SHIFT] [OPEN]

It is necessary to allow the Digibridge to reach range 1. (It must not be held on another range.) The test fixture must be physically open-circuited. Zero calibration is initiated by a "GO" command (equivalent to pressing START), which should not be followed by other commands until the Digibridge responds with "SRQ". (The purpose of the "ZO" command is to defeat the preceding "ZI" command, as you might wish to do if the "Z1" was sent by mistake.)

Limit entry commands are interpreted in relation to the previously established parameter; send the "M" command first. Use the limit entry commands in the tabulated sequence, except that nominal value need not be repeated after once being entered.

Notice that f, n, h, and l in the table are "E-notation" numbers, containing any number of digits, with optional use of decimal point and optional use of power-of-ten multiplier. Do NOT omit the semicolon after each of these. (Refer to the table.) The letter n in the table is nominal value in base units (ohms, farads, or henries). For example, nominal value can be set to 543.21 pF by the command:

N543.21E-12;

Limits for bins 1 thru 13 are entered using percentages, referred to the current nominal value. For example, Bin No.1 (designated 01) is set to +1.5%, -.05% by the command sequence:

B01H1.5;L-5E-2;



However, the limit for Bin Zero (the. desired upper limit for D or Rs or Q with R, lower limit for Rp or Q with L) is entered as a value (dimensionless for D or Q, ohms for R). For example, Bin Zero is set to 250 ppm (with parameter selection C/D) by the command:

B00H250E-6;

Frequency is entered in kilohertz. If the desired frequency is (for example) 3.25 kHz, the following command will select the nearest available frequency, which is 3.3333 kHz:

F3.25;

There are three types of commands: two-byte, three-byte, and floating-point, as described below. Each byte is coded according to the 7-bit ASCII code, using the DI01...DI07 lines. The most significant bit bit is DI07, as recommended by the Standard. (The eighth bit --DI08 --is ignored.) Thus, for example, the command for "MEASURE FUNCTION" is P0, having octal code 120 followed by 060. The two 7-bit binary bytes are therefore: 1 010 000 and 0 110 000.

Note: The ASCn code --'X3.4-1968, Code for Information Interchange' --is available from American National Standards Institute, 1430 Broadway, New York, N.Y. 10018. This code can be written out as follows. For the numerals 0, 1, 2 ...9, write the series of octal numbers 060, 061, 062 ." 071; for the alphabet A, B, C... Z, write the series 101, 102, 103 ...132. (Refer also to the table in the paragraph about "Address", in 2.8.4.) The ASCII code conforms to the 7-bit code ISO 646 used internationally.

*Two Byte and Three Byte Entries.* These command entries, as shown in Table 3-17, are simple ASCII character sequences of two or three characters. The first character is a CAPITAL letter which designates the category of the entry. The following ASCII character --or two characters if this is a three-byte entry --are decimal digits (0 to 9) which convey information about the selection within the category. For example, the ASCII sequence *D2* means "in DISPLAY category, select VALUE." The command is like pressing the [DISPLAY] key to select VALUE.

*Floating Point Entries.* These entries (also shown in the table) are ASCII character sequences of arbitrary length, always terminated with a semicolon (;). The first character is a CAPITAL letter which designates the category of the entry. The following ASCII characters --before the semicolon --define a floating-point number including at least one decimal digit (0 to 9) and optional characters (+ -e E). Any space character is ignored. The character e or E is recognized as "exponent" in E-format notation. For example, any of the following three entries will set the test frequency to 100 Hz:

F0.1; F1e-1; F100.0E-3;

## NOTES

1. The 2-byte command P2 is recommended as the first command in a remote programming sequence because it resets all selections to their power-up (default) conditions.
2. The 2-byte command P3 returns the Digibridge to the diagnostic routine and local control (i.e., the equivalent to a power-down, power-up cycle).

Table 3-17  
 COMMANDS USED IN PROGRAMMING VIA IEEE-488 BUS

Program Category	Program Selection	Command Type	Command Entry
Display	Bin #	2 byte	D0
	Delta %	2 byte	D1
	*Value	2 byte	D2
	Delta RLC	2 byte	D3
	Ratio: nominal value/RLC value	2 byte	D4
	Ratio: RLC value/nominal value	2 byte	D5
	Bin on ratio: nominal value/RLC value	2 byte	D6
	Bin on ratio: RLC value/nominal value	2 byte	D7
Measurement Rate	Fast	2 byte	S0
	Medium	2 byte	S1
	*Slow	2 byte	S2
Measurement Voltage	Constant, off	2 byte	Y0
	Constant, on	2 byte	Y1
	Value (in volts) = v	Floating Point	Vv;
Function	*Measure	2 byte	P0
	Enter	2 byte	P1
Reset	Turn-On Conditions	2 byte	P2
	Diagnostics	2 byte	P3
Measurement Mode	*Triggered	2 byte	T0
	Continuous	2 byte	T1
	Triggered median value	2 byte	T2
	Continuous median value	2 byte	T3
Parameter	Inductance (L/Q)	2 byte	M0
	Capacitance (C/D)	2 byte	M1
	Capacitance (C/R)	2 byte	M2
	Resistance (R/Q)	2 byte	M3
	Inductance (L/Q) ppm	2 byte	M4
	Capacitance (C/D) ppm	2 byte	M5
	Capacitance (C/R)	2 byte	M6
	Resistance (R/Q) ppm	2 byte	M7
	*Automatic selection of R/Q, C/D, L/Q	2 byte	M8
Equivalent Circuit	Parallel	2 byte	C0
	*Series	2 byte	C1

-----  
 \* Indicates Turn-On Conditions

Table 3-17 (Continued)  
 COMMANDS USED IN PROGRAMMING VIA IEEE-488 BUS

Program Category	Program Selection	Command Type	Command Entry
Range Control	Hold range	2 byte	R0
	Hold range 1	2 byte	R1
	Hold range 2	2 byte	R2
	Hold range 3	2 byte	R3
	Hold range 4	2 byte	R4
	*Autorange	2 byte	R5
Frequency	Value (in kHz) = f	Floating point	Ff;
Zero Calibration	Disable	2 byte	Z0
	Enable open	2 byte	Z1
	Enable short	2 byte	Z2
Output Format	*Normal (not compacted)	2 byte	x0 (Lower-case x.)
	Compacted binary format	2 byte	x1 (Lower-case x.)
Data Output	*None	2 byte	X0
	Bin #	2 byte	X1
	QDR	2 byte	X2
	QDR, Bin #	2 byte	X3
	RLC	2 byte	X4
	RLC, Bin #	2 byte	X5
	RLC, QDR	2 byte	X6
	RLC, QDR, Bin #	2 byte	X7
	RLC, QDR, Bin # on FAIL only	2 byte	X8
	Same on FAIL; Bin # on PASS	2 byte	X9
Nominal Value	Value (in ohms, henries, farads) = n	Floating point	Nn;
Limit Entry	Bin #	3 byte	Bbb
	High limit (in %) = h	Floating point	Hh;
	Low limit (in %) = l	Floating point	Ll;
Initiation	Start a measurement (like start switch)	2 byte	G0
Manual Start	*Enable switch	2 byte	W0
	Disable switch	2 byte	W1
Keyboard Lock	*Unlock	2 byte	K0
	Lock	2 byte	K1

-----  
 \* Indicates Turn-On Conditions

Table 3-17 (Continued)  
 COMMANDS USED IN PROGRAMMING VIA IEEE-488 BUS

Program Category	Program Selection	Command Type	Command Entry
Average	# of measurements = a	Floating point	Aa;
Internal Bias	*Off	2 byte	U0
	On	2 byte	U1
Bin Summary	Disable output	2 byte	E0
	Enable output	2 byte	E1
	Reset bin summary to 0	2 byte	E2
Measurement Routines	Normal routine (highest speed)	2 byte	Q0
	Signal reversal (use for low frequency hum rejection)	2 byte	Q1
	Shorting between measurements (used for reducing transient-recovery time within measuring circuit, when measuring with bias; NOT FOR DISCHARGING THE DUT).	2 byte	Q2
	Signal reversal <i>and</i> shorting between measurements	2 byte	Q3
	Quick-acquisition feature	2 byte	Q4
	Quick acquisition & shorting	2 byte	Q5
Display Digit Blanking	Eliminate (a) digits from RLC, (b) digits from QDR	3 byte	Oab
Integration-Time Multiplying Factor	Value (i) multiplies MEDIUM and FAST integration times	Floating point	Ii;
Delay	Value (in ms) = j	Floating point	Jj; **

\* Indicates Turn-On Conditions

\*\* Delay command must be entered after frequency command. (Inverting this sequence will cause delay to revert to its default value.)

Table 3-18  
MESSAGE ACTIVITY ON IEEE-488 BUS DURING A SIMPLE EXAMPLE OF REMOTE CONTROL

Byte order	Message*	AIN line	Comment
1	(UNT)	true	Untalk all devices.
2	(UNL)	true	Unlisten all devices.
3**	(MLA 3)	true	Set Digibridge (address 3) to listen.
4	(MTA n)	true	Set controller (address n) to talk.
5	G	false	Typical device-dependent message: START. (See
6	0	false	Table 3-17 for "program commands".)
7	(UNL)	true	Unlisten Digibridge (must for measurement).
-	--	--	Digibridge makes measurement, asserts SRQ line to indicate completion.
8	(MLA n)	true	Set controller to listen.
9**	(MTA 3)	true	Set Digibridge to talk.
10	(space)		Typical data stream from Digibridge in
11	(space)		the format of Tables 3-11, 3-12, 3-13 sent to
12	C		controller, which will execute
13	(space)		some kind of read command
14	u		(specified by programmer) according to
15	F		destination (such as a printer).
16	(space)		
17	(space)		
18	(space)		
19	1		
20	.		
21	2		
22	3		
23	4		
24	5		
25	(CR)		
26	(LF)		

-----  
\*Message on DI01...DI08 lines is coded and interpreted differently depending on simultaneous state of AIN line (true = asserted = low, false = high). See Table 2-2.

\*\*Bytes 3 and 4 can be programmed in a single command to controller; bytes 8 and 9 similarly. Notice that we refer to factory-set address as "3" by reading a 5-bit binary number (lines DI05...DI01).

### 3.12.4 Data Output in Compacted Binary Format

The compacted binary format for data output can be selected to save time. Selection must be made via IEEE-488 bus, not via the keyboard. The time saving is indicated by the fact that this format conveys a full set of test results in 8 binary bytes, compared to 44 binary bytes required by the regular format. Fewer characters are sent if you select less than complete results (such as bin number only, output only for FAIL, etc).

The data stream for one measurement consists of two to eight 8-bit bytes, depending on what output is programmed. The format is explained partly in truth Table 3-19, and partly in the text that follows.

#### NOTE

The 8 bits in each byte are 76543210, where 0 is LSB (least significant bit). The vertical line or space between bytes is for clarity only, not present in data.

The full eight bytes are sent only if RLC, QDR, and Bin information is needed (i.e., only if "status" bits 2,1,0 are logic 111. Otherwise, the data word is shortened, as follows.

If QDR data are NOT needed, the data format uses 5 bytes as follows.

If both QDR and BIN data are not needed, the "OTHER" byte is omitted.

Name:	STATUS	RLC, e	RLC, mantissa	OTHER	
Byte Number:	byte 1	byte 2	byte 3 byte 4	byte 5	
-----	-----	-----	-----	-----	

If RLC data are NOT needed, the data format uses 5 bytes as follows.  
If both RLC and BIN data are not needed, the "OTHER" byte is omitted.

Name:	STATUS	QDR, e	QDR, mantissa	OTHER	
Byte Number:	byte 1	byte 2	byte 3 byte 4	byte 5	
-----	-----	-----	-----	-----	

If only BIN data are needed. the data format uses only 2 bytes, as follows.  
If RLC, QDR, and BIN data are all NOT needed, no data output occurs.

Name:	STATUS	OTHER	
Byte Number:	byte 1	byte 2	
-----	-----	-----	

The *RLC,e* byte (except for bit 7) conveys the RLC exponent (2s complement). The *RLC,mantissa* bytes (all 16 bits) convey the RLC mantissa (base 2).

The *QDR, e* byte (except for bit 7) conveys the QDR exponent (2s complement).

The *QDR,mantissa* bytes (all 16 bits) convey the QDR mantissa (base 2).

The binary exponent and mantissa define a binary floating-point number, as follows:

$$(\text{exponent}) \\ (\text{Sign}) (2 \quad \quad \quad) * (\text{mantissa})$$

Table 3-19  
TRUTH TABLE OF COMPACTED BINARY FORMAT FOR OUTPUT DATA

Name:	STATUS	RLC, e	RLC, mantissa	QDR, e	QDR, mantissa	OTHER
Byte Number:	byte 1	byte 2	byte 3 byte 4	byte 5	byte 6 byte 7	byte 8
-----	76543210	7-----	-----	7-----	-----	76543210
Normal meas'mt	00 *					
Overrange	01					
Underrange	10					
Invalid meas'	11					
Range 1	00					
Range 2	01					
Range 3	10					
Range 4	11					
Bin number	001					
QDR	010					
QDR & bin no.	011					
RLC	100					
RLC & bin no.	101					
RLC, QDR, bin #	111					
RLC value is +		0				
RLC value is -		1				
QDR value is +				0		
QDR value is -				1		
Parameter L/Q						00
Parameter C/D						01
Parameter C/R						10
Parameter R/Q						11
Ratio (either)						00
Delta percent						01
Value (default)						10
Delta RLC						11
BIN 0						0000
BIN 1						0001
BIN 2						0010
BIN 3						0011
BIN 4						0100
(etc)						
(etc)						
BIN 13						1101
BIN 14						1110

\* Bit 3 of STATUS byte does not convey data.

The following examples illustrate how to obtain ordinary (base-10) numbers from the compacted binary data.

**EXAMPLE 1.** (Bytes are shown separated by spaces.)

STATUS	RLC, e	RLC, mantissa		QDR, e	QDR, mantissa		OTHER
byte 1	byte 2	byte 3	byte 4	byte 5	byte 6	byte 7	byte 8
76543210	76543210	76543210	76543210	76543210	76543210	76543210	76543210
0001x111	01100101	11100001	00001001	01110101	10100000	00000000	01100111

The example-1 interpretation is as follows:

Byte 1: Normal measurement. Range 2. RLC, QDR, and bin number data are needed.

Byte 2, bit 7: Sign of C value is +.

Byte 2, other bits: C exponent is 1100101 in 2s complement notation, which is the same as a negative exponent of 011011 (i.e., -27, base 10).

NOTE 1: bit 6 is always 1 for a negative exponent, 0 for a positive exponent.

Bytes 3, 4: C mantissa is .879044 (directly from the 16-bit binary number).

NOTE 2: In the mantissa, the first bit has the weight of 0.5, the next bit 0.25, the next bit 0.125, and each other bit half of the one before it, to the 16th bit.

Therefore, the C value is  $+ (2 \text{ to the } -27\text{th power}) * (.879044) = (7.45058) * (10 \text{ to the } -9 \text{ power}) * (.879044) = 6.54939 * 10 \text{ e}(-9) \text{ farads} = 6.5494 \text{ nF}$ .

Bytes 5, 6, and 7 (by the same method as bytes 2, 3, and 4):  $D = .0003$  Byte 8: Parameters are C/D. Data numbers are values (normal). Bin 7 assignment.

**EXAMPLE 2.** (Bytes are shown separated by spaces.)

STATUS	RLC, e	RLC, mantissa	
byte 1	byte 2	byte 3	byte 4
76543210	76543210	76543210	76543210
0010x010	00001010	10100011	00011100

The example-2 interpretation is as follows:

Byte 1: Normal measurement. Range 3. RLC data are needed.

Byte 2, bit 7: Sign of R value is +.

Byte 2, other bits: R exponent is 0001010 in 2s complement notation, which is the same as a positive exponent of 001010 (i.e., +10, base 10). (See NOTE 1, above.) Bytes 3, 4: R mantissa is .637146 (from the 16-bit binary number; see NOTE 2, above).

Therefore, the R value is  $+ (2 \text{ to the } +10\text{th power}) * (.637146) = (1024) * (.637146) = 652.44 \text{ ohms}$ .



### 3.13 SELF CHECKS AND FAILURE DISPLAYS (ERROR CODES)

#### 3.13.1 Power-Up Self Check

Every time the instrument is switched ON or the line voltage reappears after an interruption, the Digibridge keeps itself busy for a short time going through an automatic self-check routine. The RLC and QDR displays indicate in code which check is being performed. It is possible to halt the diagnostic routine and hold the displayed code by pressing and holding the [SHIFT] key or other key. Normally these displays follow one another rapidly. However, if one of them persists, there has been a failure in the self check. The nature of the failure and the proper remedy for each are indicated below. Normal operation is inhibited in each of these cases.

#### NOTE

Operation can usually be enabled (in spite of failure messages other than 88888 or 33333) by pressing START button. This action is useful to enable measurements using a test fixture with very large capacitance or for certain transfer impedance measurements. But, it IS NOT RECOMMENDED unless you are well aware of what caused the self-check failure.

88888 8888. The random-access-memory read/write exercise was imperfect. Try power-up again; otherwise the remedy is beyond the operator's control; repair service is required.

77777 XXXX. The detector test was not completed satisfactorily. Be sure that the EXTERNAL BIAS switch is OFF; try power-up again. Otherwise the remedy is beyond the operator's control; repair service is required. (The QDR display provides some service information indicating in code which of 4 important digital signals is stuck, and whether high or low.)

66666 XXXX. The detector scale test failed. CPU will loop on failure. Switch POWER OFF and ON again. If these remedies are ineffective, repair service is required.

555 D XXXX. A signal-strength check failed. When D is 1..4, it indicates the range being checked (with voltage = 1.275 V). When D is 5, the range is 4, with voltage = .075 V. CPU will loop on failure. Be sure that the EXTERNAL BIAS switch is OFF and check to make sure that the charged capacitor protective fuse has not blown (Item 11, Figure 1-3). Recycle power OFF and ON to exit from loop.

444 E XXXX. A check on test frequency and waveform failed. For E of 1, 2, 3, 4, 5, 6, the frequency being checked is 6.06, 6.0, 1.2, 0.48, .0968, .0118 kHz, respectively. CPU will loop on failure; recycle power OFF and ON to exit from loop.

33333 XXXX. PROM data checksum test. XXXX = checksum, which must be zero to pass the test.

222 F XXXX. Calibration constants test. XXXX = normalized value of constant, which must be within the limits of 1.00000 +/- 0.78125 to pass the test. For F = 0, the constant is frequency correction factor. For F = 1, 2, 3, or 4, it is the conductance of range 1, 2, 3, or 4, respectively.

You can proceed from this power-up self-check failure (222 F XXXX) and operate the Digibridge. To do so, press the [C/D] key. Of course, the measured results are liable to be erroneous; you should then proceed to obtain service to repair the fault and/or recalibrate.

11111 1111. Failure of the high-speed math chip on the 1689-9620 high-speed measurement and IEEE/handler interface option. (This check is performed only if that option is present.)

You can proceed from this power-up self-check failure (11111 1111) and operate the Digibridge. To do so, press the [C /D] key. Interface functions can be expected to work properly. However, the Digibridge will operate at its regular speed (as though the high-speed option were absent) if it has this failure.

### 3.13.2 Failure Display due to Signal Overload

"014 " (*right display blank*) Occurrence of an unrecoverable signal overload during the last measurement. This means that a signal overload occurred during RANGE HELD or while measuring on Range 4. Otherwise (if a signal overload occurs on range 1, 2, or 3 and range is NOT held), this failure display is not shown; instead, the Digibridge will change to the next higher-numbered range and try again.

Signal overload can result from any of five causes:

1. RANGE HELD and CONSTANT VOLTAGE with impedance value too low for the range. 2.

Transient voltage from charged capacitor.

3. Transient due to application of bias voltage.

4. Hardware failure.

5. LC resonance effect (measuring inductance).

### 3.13.3 Failure Display due to Abnormal Measurement Cycle

22222 xxxx. The Digibridge will abort the measurement and provide this display if there is (even once during a measurement) a converter/detector malfunction such that the integrator's conversion cannot be completed. There are two versions of this failure:

22222 2222. The cycle is "too long". Integrator voltage does not return to zero in reasonable time.

22222 1111. The cycle is "too short". Integrator voltage was already zero (or wrong polarity) when conversion began.

### 3.13.4 Failure Display due to LC Resonance

A display of "0 14 " or 22222 1111 can occur, in place of the expected L and Q, because the inductor being measured resonates with measuring circuit capacitance. (Resonance can cause an overload of the converter/detector.) The Digibridge thus presents an easily noticed failure display rather than an invalid measurement result.

*When Expected.* This resonance effect can be expected when large values of inductance are being measured at high frequency. In particular, if the Digibridge is autoranging, this effect can be expected in range 1 under any of the following 4 equivalent conditions. (A representative value of L that will cause selection of range 1 is indicated in parentheses beside each condition.)

1. Without extender cable,  $f > 3.8 \text{ kHz}$  ( $L > 1 \text{ H}$  at 4 kHz).
2. With 1688-9600 cable (874 connectors),  $f > 2.8 \text{ kHz}$  ( $L > 1.3 \text{ H}$  at 3 kHz).
3. With 1657-9600 cable (banana plugs),  $f > 1.1 \text{ kHz}$  ( $L > 3 \text{ H}$  at 1.2 kHz).
4. With 1689-9602 cable (*BNC/BNC*),  $f > 2 \text{ kHz}$  ( $L > 2 \text{ H}$  at 2 kHz).
5. With any other cable and remote test fixture, use the following formula:  

$$f > 770 \sqrt{L(200 + C)}$$

where  $f$  is in kHz,  $C$  is stray capacitance outside of the Digibridge, from the high (Ih, Ph) terminal to ground (guard), expressed in pF. (Measurement will be on range 1 if  $L > 4/f$ .)

This resonance effect can also be expected under some conditions of high-frequency measurement with range 1 held but the inductance of the DUT appropriate for range 2. The effect is NOT expected with autoranging in ranges 2, 3, 4, unless stray capacitance is considerably larger than that of the 1657-9600 extender cable.

It is possible for valid measurement, with a slight reduction in accuracy, to be made under conditions very close to those that will trigger the LC resonance failure display. Such a measurement can be expected to meet accuracy specifications if it is displayed at all.

*Recommended Procedure.* If this LC-resonance failure display appears, in the course of otherwise normal measurements, the instrument is functioning normally. Valid measurements can usually be made by taking one or more of the following steps.

- a. Select low source impedance, by pressing [SHIFT] [CONST VOLTAGE] so that the CONSTANT VOLTAGE indicator lights up.
- b. Select a low-impedance range. For example, if measurement is normally in range 1, try holding range 2; or if range 1 has been held, select autorange.
- c. Reduce the measurement frequency.
- d. If cable and test fixture capacitance can be reduced, do so.
- e. If this resonance effect is not easily avoided, consider that the DUT may be self-resonant. If so, unqualified measurements of apparent inductance are misleading. Try a set of measurements of apparent inductance at several frequencies sufficiently low (or high) to avoid the resonance failure display. NOTE: If the NEG RLC indicator is lit, with indicated units of mH or H, the measured reactance is capacitive, although the RLC display is a number of millihenries or henries.

### 3.14 SAMPLE IEEE PROGRAMS

Below are three sample IEEE-488 programs using three different IEEE controllers. These programs are intentionally very short and are intended as aids to demonstrate to the programmer how to operate a Digibridge using a typical controller. It is assumed that the Digibridge address is set to 3.

#### 3.14.1 Programming Hints

- a. The initiation (start) command is "GO". This is the number 0, not the letter O.
- b. It is good practice to begin a new program with a "P2" command. This will reset all parameters to the known turn-on state. If "P2" is used later in the program, it will reset everything, including Nominal Value and any Bin Limits that may be set.

c. An "X" command must be sent to enable data output.

d. The string "P2A10;M3X4Z2G0" should be sent for the Short Circuit Zero. A frequency other than 1 kHz can be sent, if needed.

e. The string "P2A10;M1X4Z1G0" should be sent for the Open Circuit Zero. A frequency other than 1 kHz can be sent, if needed.

f. All commands sent to the Digibridge must be followed by an UNL (unlisten) and then ATN (attention) must be unasserted. If the instrument is set to TALK, this should happen automatically.

### 3.14.2 Hewlett Packard HP85

```
100 REMOTE 703
110 OUTPUT 703; "P2X4G0"
120 ENTER 703; C$
130 DISP C$
140 LOCAL 703
150 SEND7; UNL @ RESUME 7
160 END
```

### 3.14.3 Capitol Equipment Corp. PC-488 Card with the IBM-PC

```
100 DEFINT A-Z
110 DEF SEG=&HC000
120 INIT=0 : TRANSMIT=3 : ENTER=21
130 MY.ADDR=21 : SYSTEM.CONTROL=0
140 DIGIBRIDGE=3
150 CALL INIT (MY.ADDR, SYSTEM.CONTROL)
160 REN$="REN"
170 CALL TRANSMIT (REN$, STATUS)
180 M$="P2X4G0"
190 ST$="LISTEN 3 MTA DATA '"+M$+' UNL"
200 CALL TRANSMIT (ST$, STATUS)
210 R$=SPACE$(17)
220 CALL ENTER (R$, LENGTH, DIGIBRIDGE, STATUS)
230 PRINT " MEASUREMENT IS: ";R$
240 END
Ok
```

### 3.14.4 National Instruments GPIB-PCII Card With The IBM-PC

```
100 '*****INITIALIZE BRIDGE*****
110 ADAP$="GPIB0" : DIGI$="DIGI":V%=1
120 CALL IBFIND (ADAP$,GPIB0%):CALL IBSIC (GPIB0%)
130 IF IBSTA% < 0 THEN GOTO 120
140 CALL IBGTS (GPIB0%,V%)
150 CALL IBFIND (DIGI$,DIGI%)
160 CLS '*****MEASURE AND DISPLAY DATA*****
170 C$=SPACE$(20):D$=SPACE$(20)
180 SET$="P2X6G0" ' bridge setup string
190 CALL IBWRT (DIGI%,SET$) ' send string to bridge
200 CALL IBRD (DIGI%,C$): CALL IBRD (DIGI%,D$)' read measurement results
210 PRINT C$;D$ ' display results
220 CALL IBLOC (DIGI%) : CALL IBGTS (GPIB0%,V%)
' return to local control

230 END
Ok
```

---

# Theory – Section 4

---

4.1 INTRODUCTION . . . . .	4 - 1
4.2 PRINCIPAL FUNCTIONS . . . . .	4 - 4

## 4.1 INTRODUCTION

### 4.1.1 General

This instrument uses an unusual method of measurement, which is quite different from those used in most previous impedance meters or bridges. A thorough understanding of this method will be helpful in unusual applications of the instrument. The following paragraph gives a brief overall description outlining the measurement technique to one familiar with impedance measurement methods. A more detailed description of operation, specific circuitry, and control signals is given later.

### 4.1.2 Brief Description of the 1689 Digibridge.

This Digibridge(R) RLC tester uses a patented measurement technique, in which a microprocessor calculates the desired impedance parameters from a series of 6 or 8 voltage measurements (6 for FAST, 6 for MED, and 8 for SLOW measurement rates). These measurements include quadrature (90 degree) and inverse (180 degree) vector components of the voltages across the device under test  $Z_x$  (the DUT), and across a standard resistor  $R_s$  carrying the same current as the DUT. Each of these voltage measurements is meaningless by itself, because the reference signals have no particular phase relationship to the measured analog signals, and because the current through  $Z_x$  is not controlled. Each set of voltage measurements is made in rapid sequence with the same phase-sensitive detector and analog-to-digital converter. Therefore properly chosen differences between these measurements subtract out fixed offset errors, and ratios between them cancel out the value of the common current, the scale factor of the detector-converter, and the effect of the relative reference-to-signal phase angle.

The phase-sensitive detector uses 4 reference signals, precisely 90 degrees apart, that have exactly the same frequency as the test signal, but whose phase relationship to any of the analog voltages or currents (such as the current through  $Z_x$  and  $R_s$ ) is incidental. Therefore, no precise analog phase shifter or waveform squaring circuit is required. Correct phase relationships are maintained by generating test signal and reference signals from the same high-frequency source.

Because of the measurement technique and circuitry, the only calibration adjustment in the Digibridge is the factory setting of the test-voltage-level reference. The only precision components in this instrument are four standard resistors and a quartz-crystal stabilized oscillator. There is no reactance standard. For example, C and D are calculated by the microprocessor from the set of voltage measurements, the predetermined frequency, and the calibrated  $R$  and  $Q$  of the applicable standard resistor.

In these calculations, the microprocessor automatically removes from the measured result the parameters of the test connection ("stray" capacitance and conductance and series resistance and inductance), if simple open-circuit and short-circuit "ZERO" calibration measurements have been performed by the operator. The values obtained during "ZERO" calibration are stored in Digibridge memory and retained during power-down and power up.

The impedance of each internal standard resistor is similarly stored in memory for use by the microprocessor in the calculation of parameters being measured. (For this purpose, the Digibridge measures its own internal standard resistors against an external standard during factory calibration ---and recalibration, if any.) Therefore, the impedances of the internal resistance standards are known at the calibration frequency (usually 1 kHz), and are computed by the microprocessor for other test frequencies.

The Digibridge also stores the frequency error of its crystal-referenced oscillator (actual vs nominal frequency, expressed in parts per million) so that the microprocessor uses a corrected frequency value in each calculation of capacitance or inductance from measured impedance. This frequency correction is programmed into the Digibridge during factory calibration ---and recalibration, if any.

The microprocessor controls the measurement sequence, according to programs in the read-only memory, using stored operator selections that are made available through keyboard control or (if you have the interface option) by remote-control command. Selections include for example --parameters: R and Q, L and Q, C and D, or C and R; test voltage: .005 to 1.275 V; equivalent circuit: series or parallel; test rate: SLOW, MEDIUM, or FAST; frequency: programmable from 12 Hz to 100 kHz in 503 steps; delay: up to 99999 ms; and averaging: 2 to 255 measurements; etc.

The instrument normally autoranges to find the correct range; but operation can be restricted to any of the four ranges (1, 2, 3, 4), under keyboard control. Each range is 4 octaves wide (16:1), with reduced-accuracy extensions both above and below.

Leading zeroes before the decimal point are blanked out of the RLC and QDR displays.

#### **4.1.3 Block Diagram.**

#### **Figure 4-1.**

The block diagram shows the microprocessor in the upper center connected by data and address buses to digital circuitry including memories (RAM and ROM) and peripheral interface adaptors (PIAs).

Analog circuitry is shown in the lower part of the diagram, where  $Z_x$  is supplied with a test signal at frequency  $f$  from a sine-wave generator, driven by a crystal-controlled digital frequency divider circuit. The P/I signal selector and instrumentation amplifier supply an analog signal that represents 2 impedances alternately: the appropriate internal resistance standard,  $R_s$ , and the DUT,  $Z_x$ .

The phase-sensitive (dual-slope) detector and measurement counters convert this analog signal into digital form. See circuit descriptions below.

From this information and criteria selected by the keyboard (or remote control), the microprocessor calculates the RLC and QDR values for display, averaging, bin assignments, etc. The 1689M Digibridge calculates faster than the 1689 Digibridge.

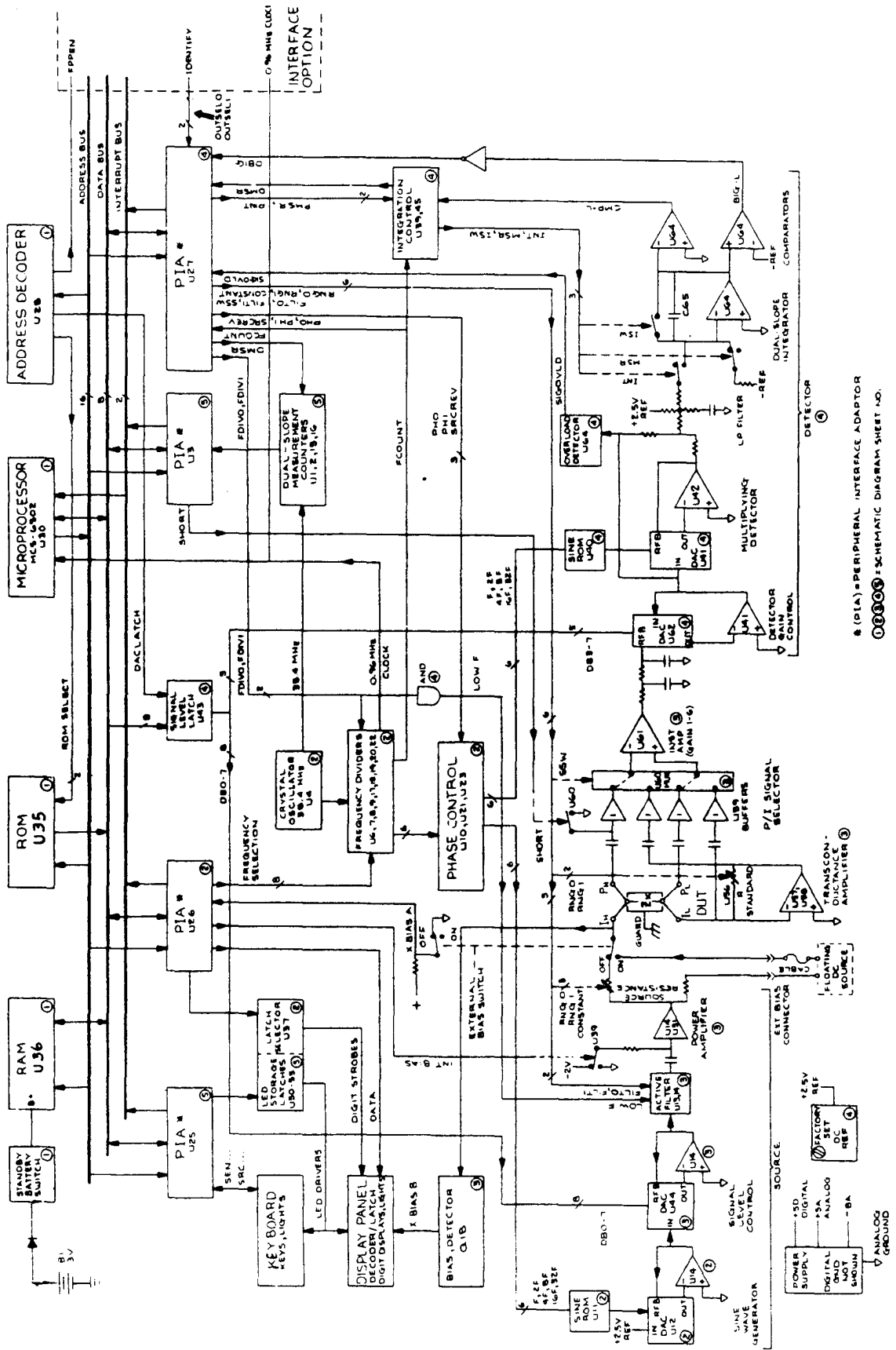

Figure 4-1. Block diagram of the 1689 Precision RLC Digibridge.



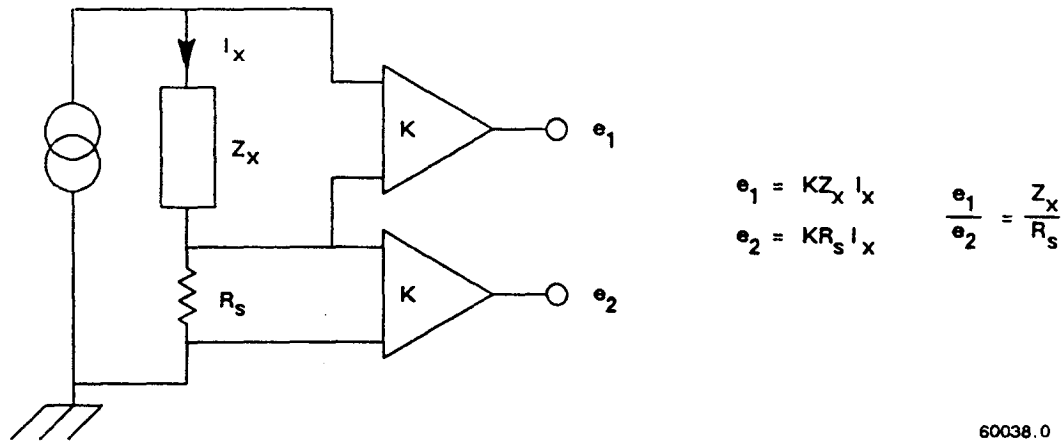

Figure 4-2. Elementary measurement circuit.

## 4.2 PRINCIPAL FUNCTIONS

### 4.2.1 Elementary Measurement Circuit

Figure 4-2.

The measurement technique is illustrated by the accompanying simplified diagram, which can be correlated with the previous (block) diagram. A sine-wave generator drives current  $I_x$  through the DUT  $Z_x$  and standard resistor  $R_s$  in series. Two differential amplifiers with the same gain  $K$  produce voltages  $e_1$  and  $e_2$ . Simple algebra, some of which is shown in the figure, leads to the expression for the "unknown" impedance:

$$Z_x = R_s [e(1)/e(2)]$$

Notice that this ratio is complex. Two values (such as  $C$  and  $D$  or  $L$  and  $Q$ ) are automatically calculated by the microprocessor from  $Z_x$ , frequency, and other information.

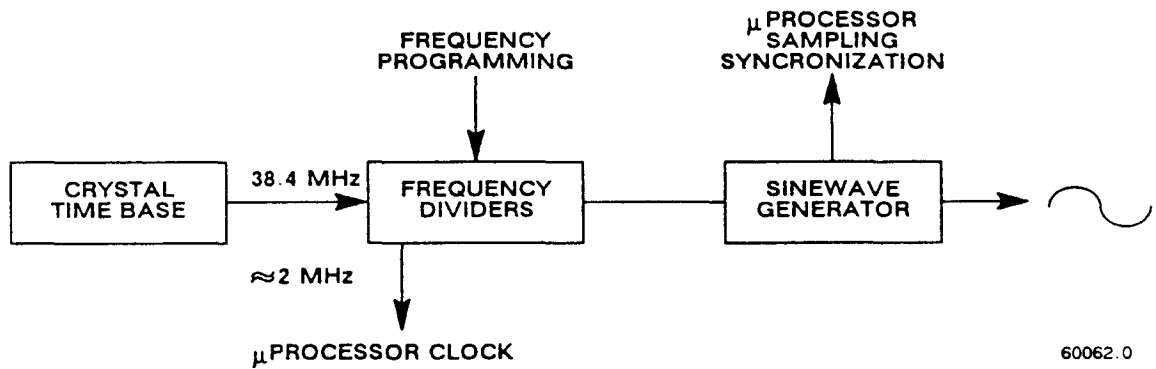

Figure 4-3. Frequency and timing source. Several clocks and synchronizing pulses as well as the measurement signal  $f$  are derived from the accurate time-base signal.

#### 4.2.2 Frequency and Time Source

Figure 4-3.

A necessary standard for accuracy is the frequency of the test signal; and equally important are the generation of multi-phase references for detection and clocks for the microprocessor. Frequency and timing requirements are implemented by derivation from a single very accurate oscillator, operating at 38.4 MHz. Digital dividers and logic circuitry provide the many clocks and triggers, as well as driving the sine-wave generator described below.

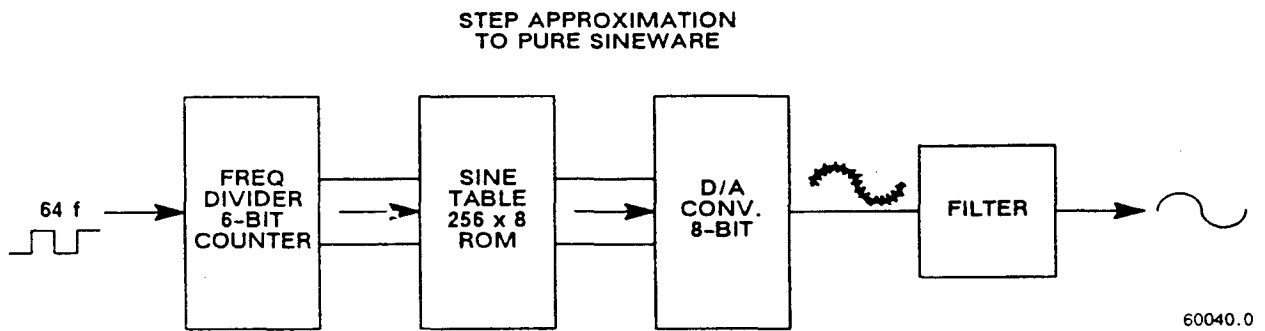

Figure 4-4. Sine wave generator. Given square waves at frequencies of  $64 f$ ,  $32 f$ ,  $16 f$ ,  $8 f$ ,  $4 f$ ,  $2 f$ , and  $f$ , a ROM containing the mathematical sine function drives a D/A converter to form a finely stepped approximation to a sine wave at frequency  $f$ . The filter provides smoothing of the test signal.

#### 4.2.3 Sine-Wave Generation

Figure 4-4.

*Source of the Test Signal.* Starting with a digital signal at 64 times the selected test frequency, the sinewave generator provides the test signal that drives a small but essential current through the DUT. The sine wave is generated as follows

Binary dividers count down from 64 f, providing signals at 32 f, 16 f, ...2f, f. This set of signals is used to address a read-only memory which contains a 64-step approximation to a sine function. The ROM output (as an 8-bit binary number) is converted by a D/A converter to a stepped approximation of a sine-wave, which is then smoothed by filtering before its use in the measurement of a DUT. The filter is switched appropriately, according to the selected test frequency.

*Source of the Reference Sine Wave for the Multiplying Detector.* Another sine-function ROM is addressed by the same digital signals (64 f through f) to produce another stepped approximation of a sine wave at 0 degrees. Suitable inversions of signals 2f and/or f serve to shift the phase of the output sine wave, under microprocessor control, by 90, 180, or 270 degrees.

#### 4.2.4 The Dual-Slope Integrating Detector and Converter

(See Figure 4-1.)

*Circuitry.* The phase-sensitive detector/converter circuit consists of a multiplier whose dc output is measured by a dual-slope converter, providing the measurement in digital form. The multiplier is a multiplying D / A converter whose "reference" input is the test signal and whose digital controls are signals representing a stepwise approximation of a reference sine wave at the test frequency. The dc value of the multiplier output is proportional to the product of signal magnitude multiplied by the cosine of the phase angle between the test signal and the reference sine wave.

The dual-slope converter includes these three stages: dual-slope integrator, comparator, and counter (all controlled by the microprocessor through PIAs). In the dual-slope integrator, a capacitor is charged for a controlled integration time interval (sampling) at a rate proportional to the multiplier output voltage. This capacitor is then discharged at a fixed rate (the deintegration slope) to zero voltage, a condition that is sensed by a comparator. (See signal name "CMP-L" on the block diagram.) Thus, the integrator and comparator transform the sampled dc output from the multiplier into a precise interval of time. The dual-slope measurement counter is gated by this time interval, thus converting it into a digital number, which is a principal data input to the microprocessor.

If the integration time is relatively long, so that the integration capacitor voltage reaches a certain reference level, another comparator triggers the beginning of the return (deintegration) slope before sampling has been completed. (See signal name "BIG-L" on block diagram.) The detector is then sampling and converting simultaneously for a portion of the dual-slope conversion cycle.

*Data Acquisition Time.* Data acquisition time includes pauses for synchronization, and several integration / deintegration cycles.

A pause for synchronization varies depending on timing relationships among the START signal, length of settling time or programmed delay, length of the previous integration/deintegration cycle, and the Digibridge clocks (particularly FCOUNT, shown on block diagram). This pause can be as much as one test-frequency period for high frequencies or up to 1/32 of the test-frequency period for low frequencies.

The integration (sampling, gate, or capacitor charging) time of the dual-slope integrator is the number of full periods of the test frequency whose sum is closest to (4 ms)x(integration-time factor) for FAST, closest to but not over (16.7 ms)x(integration-time factor) for MEDIUM, or closest to but not over 100 ms for SLOW measurement rate. (The integration-time factor is normally 10 but can be programmed between 0.25 and 6.)

The return (deintegration) time depends on the dc voltage being converted and whether "BIG-L" has

been triggered (see above); therefore, this time requirement varies in a complex manner.

Data acquisition includes several complete dual-slope conversion cycles, with the reference sine wave at 3 or 4 different phases, exactly 90 degrees apart, as follows:

For FAST and MEDIUM rates, 6 cycles (2 each with reference phases of 0, 90, and 180).

For FAST and MEDIUM rates if "quick acquisition" special function is enabled, 5 cycles.

For SLOW measurement rate, 8 cycles (2 each with ref phases of 0, 90, 180, and 270).

Therefore, data acquisition time is a complex, discontinuous function of test frequency, the selected measurement rate, programmed integration-time factor, enabling or disabling of "quick acquisition", and pauses for synchronization.

5.1	CUSTOMER SERVICE.....	5-3
5.2	INSTRUMENT RETURN.....	5-3
5.3	REPAIR AND REPLACEMENT OF CIRCUIT BOARDS	5-3
5.4	PERFORMANCE VERIFICATION.....	5-3
5.5	DISASSEMBLY AND ACCESS.....	5-11
5.6	PERIOOIC MAINTENANCE .....	5-26
5.7	TROUBLE ANALYSIS.....	5-28
5.8	ACCURACY VERIFICATION.....	5-38
5.9	RECALIBRATION.....	5-51
5.10	INTERNAL SETTINGS.....	5-60

### WARNING

These servicing instructions are for use by qualified personnel only. To avoid electrical shock, do not perform any servicing, other than that contained in the operating instructions, unless you are qualified to do so.

### CAUTION

For continued protection against fire hazard, replace fuse only with same type and rating as shown on rear panel and in parts list.

Service personnel, observe the following precautions whenever you handle a circuit board or integrated circuit in this instrument.

## HANDLING PRECAUTIONS SUBJECT TO DAMAGE BY STATIC ELECTRICITY

Place instrument or system component to be serviced, spare parts in conductive (anti-static envelopes or carriers, hand tools, etc.), on a work surface defined as follows. The work surface, typically a bench top, must be conductive and reliably connected to earth ground through a safety resistance of approximately 250 kilohms to 500 kilohms. Also, for personnel safety, the surface must NOT be metal. (A resistivity of 30 to 300 kilohms per square is suggested.) Avoid placing tools or electrical parts on insulators, such as books, paper, rubber pads, plastic bags, or trays.

Ground the frame of any line-powered equipment, test instruments, lamps, drills, soldering irons, etc., directly to earth ground. Accordingly, (to avoid shorting out the safety resistance) be sure that grounded equipment has rubber feet or other means of insulation from the work surface. The instrument or system component being serviced should be similarly insulated while grounded through the power-cord ground wire, but must be connected to the work surface before, during, and after any disassembly or other procedure in which the line cord is disconnected.

Exclude any hand tools and other items that can generate a static charge. (Examples of forbidden items are non-conductive plunger-type solder suckers and rolls of tape.)

Ground yourself reliably, through a resistance, to the work surface; use, for example, a conductive strap or cable with a wrist cuff. The cuff must make electrical contact directly with your skin; do NOT wear it over clothing. (Resistance between skin contact and work surface through a commercially available personnel grounding device is typically in the range of 250 kilohms to 1 megohm.)

If any circuit boards or IC packages are to be stored or transported, enclose them in conductive envelopes and/or carriers. Remove the items from such envelopes only with the above precautions; handle IC packages without touching the contact pins.

Avoid circumstances that are likely to produce static charges, such as wearing clothes of synthetic material, sitting on a plastic-covered or rubber-footed stool (particularly while wearing wool), combing your hair, or making extensive erasures. These circumstances are most significant when the air is dry.

When testing static-sensitive devices, be sure dc power is on before, during, and after application of test signals. Be sure all pertinent voltages have been switched off while boards or components are removed or inserted, whether hard wired or plugged in.

The symbol shown below may appear on circuit boards and/or schematic diagrams to call attention to static sensitive component parts. However, the absence of such a symbol does NOT assure the absence of static sensitive devices.

## CERTIFICATION

Products provided by GenRad are thoroughly tested and calibrated to meet product specifications. A Record of Certification of conformance (which certifies that the product meets its specifications and that its calibration is traceable to appropriate national standards) is available upon request at the time of purchase.

## 5.1 CUSTOMER SERVICE

Our warranty (at the front of this manual) attests the quality of materials and workmanship in our products. If malfunction does occur, our service engineers are available for technical telephone assistance. If the difficulty cannot be eliminated by use of the following service instructions, please contact GenRad's Technical Assistance Center (see last page in this manual) giving full information of the trouble and of steps taken to remedy it. Describe the instrument by name, catalog number, and serial number. (Refer to Digibridge front and rear panels. )

## 5.2 INSTRUMENT RETURN

### 5.2.1 Return Material

Before returning an instrument to GenRad for service, contact our nearest Service and Logistic Center for return shipping instructions (see last page).

### 5.2.2 Packaging

To safeguard your instrument during storage and shipment, please use packaging that is adequate to protect it from damage, i.e., equivalent to the original packaging. Any GenRad field office can advise. Contract packaging companies in many cities can provide dependable custom packaging on short notice. Mark the box "Delicate Instrument".

## 5.3 REPAIR AND REPLACEMENT OF CIRCUIT BOARDS

This instruction manual contains sufficient information to guide an experienced and skillful electronic technician in fault analysis and the repair of some circuits in this instrument. Contact QuadTech's Technical Assistance Center if additional help is needed (see last page).

### U.S.A

Sales 800-253-1230

Service 978-461-2100

## 5.4 PERFORMANCE VERIFICATION

### 5.4.1 General

This procedure is recommended for verification that the Digibridge is performing normally. No other check is generally necessary because this procedure checks operation of nearly all of the circuitry. If the Digibridge passes this performance verification, it is safe to assume that the instrument is functional. (However, to insure *accuracy*, refer to paragraph 5.8, Accuracy Verification.)

All tests are done at 1 kHz, 1 volt NOT CONSTANT, and in SLOW measure rate so that basic bridge accuracy is realized. The accuracy of each verification is therefore  $\pm .02\%$  plus the tolerance of the verifying DUT, which is discussed below. Table 5-1 lists the necessary resistors, capacitors, and inductors, which are inexpensive and readily obtained. The most accurate ones available should be used; tolerances listed are the "best" commonly catalogued. There are no calibrations and only one adjustment that could require resetting; and the internal standards are very stable. This procedure checks at least one point on each of the four measurement ranges.

Table 5-1  
COMPONENTS RECOMMENDED FOR PERFORMANCE VERIFICATION

Component	Type *	Nominal Value	Tolerance
Resistors Metal Film	MIL-R-1C509C (Style RN60)	49.9 ohms	+/- 0.1%
		499 ohms	+/- 0.1%
		4.99 kilohms	+/- 0.1%
		49.9 kilohms	+/- 0.1%
		499 kilohms	+/- 0.1%
Capacitors			
Metalized			
Polyester	GE: BA-19A106C	10 uF	+/- 5%
Polystyrene	ARCO: 1PJ-334J	0.33 uF	+/- 0.5%
	1PJ-333J	0.033 uF	+/- 0.5%
	1PJ-332J	0.0033 uF	+/- 0.5%
Inductors			
J.W. Miller			
Non-Ferrous	9220-28	1000 uH	+/- 5%
Ferrite Core	9250-107	100 mH	+/- 10%

-----  
\* Equivalents may be substituted

### CAUTION

Be sure that the voltage switch, rear panel, is correctly set for your power line (90 to 125 V -or- 180 to 250 V), that no components are connected to the test fixture, and that the EXTERNAL BIAS switch is OFF.

#### 5.4.2 Performance Verification Procedure

a. After the line voltage switch has been set to correspond to the input line voltage, connect the line cord and switch the POWER ON.

The Digibridge then enters an automatic self-check routine and displays a sequence of codes. If one of these displays persists, a check failure has occurred and further checks or measurements are inhibited. (See paragraph 3.13.)

Normally, upon completion of the power-up self check, the following preset or default conditions are established, lighting a vertical line of indicators. (However, if the keyboard is locked, the locked-in conditions are re-established and most of the keyboard indicators are dark.) Normal:

```
[FUNCTION] --MEASURE
[DISPLAY] --VALUE
[MEASURE RATE] --SLOW
[MEASURE MODE] --CONT
[EQUIVALENT CIRCUIT] --SERIES
```



The main panel displays and indicators (RLC and QDR) will normally come up with random, meaningless readings; ignore them.

b. However, if the keyboard is locked and the MEASURE indicator is lit, to unlock it, press:

[1][6][8][9][=][LOCK]

(If you have the interface option, it is possible that the FUNCTION is locked at ENTER. Then the use of remote control signals is required either to unlock the keyboard or to select the MEASURE function, which is a prerequisite for unlocking from the keyboard).

c. Confirm or select the following measurement conditions on the Digibridge:

[FUNCTION] --ENTER (necessary for determining test frequency)  
[DISPLAY] --VALUE  
[MEASURE RATE] --SLOW  
[MEASURE MODE] --TRIGGERED (necessary for zeroing)  
[EQUIVALENT CIRCUIT] --SERIES  
EXTERNAL BIAS --OFF (slide switch)

d. Verify that the test frequency is 1 kHz (the power-up default) by pressing:

[SHIFT] [FREQUENCY]

The left-hand display should read 1.0000. If any other reading is observed press:

[1] [=] [SHIFT] [FREQUENCY]

e. Verify that the test voltage is 1 volt by pressing:

[SHIFT] [VOLTAGE]

The left-hand display should read 1.0000. If any other reading is observed, press:

[1] [=] [SHIFT] [VOLTAGE]

f. Press the [FUNCTION] key to select MEASURE function.

g. If the Digibridge has an interface option (which has two 24-pin interface connectors on the rear panel), be sure that the TALK switch (rear panel) is set to TALK ONLY.

h. Zero the Digibridge as follows, before making measurements. (Make sure that the MEASURE and TRIGGERED keyboard indicators are lit.)

*Test Fixture ---for the 1689 Digibridge.* Install the axial-lead adaptors in the test fixture in position for accepting the largest of the verifying DUTs in Table 5-1.

*Test Fixture ---for the 1689M Digibridge.* Install the BNC cable and remote test fixture, as described in paragraph 3.2.4. Install the axial-lead adaptors in the test fixture in position for accepting the largest of the verifying DUTs in Table 5-1.

### *Open Circuit Zero.*

Press the [Cs/D] key.  
Press: [1][6] [8][9] [=][SHIFT] [OPEN].  
Keep hands and all objects at least 10 cm from fixture contacts. Press  
START to initialize zeroing operation.  
Wait until the GO indicator lights.

### *Short Circuit Zero.*

Short the fixture with a piece of copper wire, pressed into the test-fixture adaptors, where the DUT leads will go. Do not move the test fixture adaptors.

Press [1][6][8][9][=][SHIFT][SHORT].  
Press START to initialize zeroing operation.  
Wait until the GO indicator lights again.  
(NOTE: For maximum accuracy, this zeroing procedure should be performed at  
the start of each day and every time the fixture configuration is changed.)

## **PRIMARY MEASUREMENT VERIFICATION**

a. Press the [MEASURE MODE] key to select CONT. (continuous measurements). b.

Press [Rs/Q].

c. Insert, as DUT, the first resistor specified in Table 5-2.

d. Verify that the displays are within the extremes shown for check number 1 in Table 5-2, if the resistor is within the tolerance listed in Table 5-1.

*NOTE ON TOLERANCES:* Acceptable performance of the instrument is bracketed by the set of display "extremes" in Table 5-2. These are defined as the nominal (ideal) measurements plus-or-minus the sum of the instrument accuracy tolerances and the DUT accuracy tolerance (or slightly more). If the accuracy of your DUT is different from the recommendation, revise the acceptable "extremes" accordingly. Notice that this performance verification is NOT intended to prove the accuracy of the instrument.

*NOTE ON INSIGNIFICANT FIGURES:* The right-hand digit(s) of the display may be expected to flicker and change (with the automatically repeating measurements) if they are not significant for the specified accuracy of the instrument. (See further comment with step i below.)

e. Similarly, make the other checks indicated in Table 5-2, under the Rs/Q parameter (checks number 2, 3, 4, 5).

f. Press [Cs/D].

g. Insert as DUT the first capacitor specified in Table 5-2 (check number 6).

h. Verify that the displays are within the extremes shown for check number 6 in Table 5-2, if the capacitor is within the tolerance listed in Table 5-1.

i. Similarly make the other checks indicated in Table 5-2 under the Cs/D parameter (checks number 6, 7, 8, 9).

## **5-6 SERVICE**

In check number 8, verify that the fifth digit is reasonably stable, as follows. (Notice that the fourth digit is the last significant one in the readout, for 0.02 percent accuracy.) In check number 8, the flickering of the fifth digit should stay typically between 2 counts. For example, if the display is 330.1X nF, the "X" might flicker between 2 and 4. If, for example, 'X' is flickering between 9 and 11, it will of course cause a flickering of the preceding digit (330.19 and 330.21). In such a case, the correct readout is the larger 4-digit number (330.2) and the fifth digit is acceptably stable.

j. Press [Ls/Q].

k. Insert as DUT the first inductor specified in Table 5-2 (check number 10).

l. Verify that the displays are within the extremes shown for check number 10 in Table 5-2, if the inductor is within the tolerance specified by Table 5-1.

m. Similarly check the inductor specified in check number 11.

## SECONDARY MEASUREMENT VERIFICATION

The following procedure will verify performance of the secondary display (D) at 1 kHz, 10 kHz, and 100 kHz. Using the 49.9 ohm resistor and 0.0033 uF capacitor listed in Table 5-1 (connected in series), the value of D can be expected to be approximately 0.0010 at 1 kHz, 0.0103 at 10 kHz and 0.1034 at 100 kHz.

NOTE: These readings are based on precise values of 49.9 ohms and 0.0033 uF. If other components are to be used, the D value must be calculated using the formula:  $D = 2\pi R_s C_s$ .

a. Press [Cs/D].

b. Insert the series combination of the 49.9 ohm resistor and 0.0033 uF capacitor in series. The Dreading should indicate approximately 0.0010.

c. Change the frequency to 10 kHz and verify D measurement as follows:

[FUNCTION] ---ENTER

Press [1] [0] [=] [SHIFT] [FREQUENCY]

[FUNCTION] ---MEASURE

The D reading should now indicate approximately 0.0103.

d. Change the frequency to 100 kHz and verify D measurement as follows:

[FUNCTION] ---ENTER

Press [1] [0] [0] [=] [SHIFT] [FREQUENCY]

[FUNCTION] ---MEASURE

The D reading should now indicate approximately 0.1034.

Table 5-2  
PERFORMANCE VERIFICATION

Check Number	Parameter	DUT	RLC Display Extremes	QDR Display Extremes
1	Rs/Q	49.9 ohms	49.840 to 49.959 ohms	*
2		499 ohms	498.40 to 499.59 ohms	
3		4.99 kilohms	4.9840 to 4.9959K ohms	
4		49.9 kilohms	49.840 to 49.959K ohms	*
5		499 kilohms	498.40 to 499.59K ohms	
6	Cs/D	0.0033 uF	3282.8 to 3317.2 pF	.0000 to .0100
7		0.033 uF	32.828 to 33.172 nF	.0000 to .0100
8		0.33 uF	328.28 to 331.72 nF	.0000 to .0100
9		10 uF	9.498 to 10.502 uF	.0000 to .0300
10	Ls/D	1000 uH	.9498 to 1.0502 mH	*
11		100 mH	89.98 to 110.02 mH	*

-----  
\* The right hand display (QDR) can be expected to change frequently; accuracy of that display is not significant in these performance checks.

### 5.4.3 Measurement-Time Checkout

This procedure verifies that the 1689 measurement rate is functioning properly. All measurements are made with the default (power-up) values of test frequency and test voltage (1 kHz and 1 V). The procedure determines the time required per measurement for several operating conditions, *without* and then *with* the high-speed option board. Make a note of each calculated result for final comparisons to verify the speed.

#### Equipment Required:

1. 1689 Digibridge without high-speed option. (To remove it, see paragraph 5.5.5.)
2. 1689-9620 High-speed measurement option board (retrofit or just removed).
3. Watch or clock with digital display of seconds or a sweep second hand.
4. A suitable DUT such as the 24.9-ohm Calibration Resistor (used in the examples, see below).

#### NOTE

The readings can be expected to vary +/- 5% from the examples given, mostly because the manual timing method is liable to such errors. The method is adequate for the purpose intended.

a. Switch the POWER ON. Perform the zeroing procedure (both open circuit and short circuit), as described in paragraph 5.9.2 of the recalibration procedure.

b. Insert the DUT (24.9 ohms +/- 0.1% for example) in the test fixture.

Press: [FUNCTION] key to select ENTER function.

Press: [2] [4] [.] [9] [=] [SHIFT] [NOM. VALUE]

Press: [.] [2] [%] [=] [SHIFT] [BIN NO.] [0] [1]

Press: [MEASURE RATE] (if necessary) to select SLOW rate.

Press: [MEASURE MODE] to select CONTINUOUS mode.

c. With the watch or clock, time the interval between the next two keystrokes. The number of measurements made while the function is MEASURE will automatically be stored in "bin sum" for bin 01.

Press: [FUNCTION] key to select MEASURE function. Wait 60 seconds.

Press: [FUNCTION] key to select ENTER function.

Press: [SHIFT] [BIN SUM] [0] [1].

d. Read the left-hand display, which is the number of measurements made in 60 seconds. (+/- 5% accuracy of timing is assumed.) Use this number as "x" in the following formula; retain these results. Note: the right-hand display should be 1, the bin number being reported.

$$\text{Measurement time} = T = 60,000 \text{ milliseconds} / x$$

For example, if  $x = 58$ , then  $T = 1034 \text{ ms} \pm 5\%$ .

e. Clear all "bin sum" registers as follows. Note: the Digibridge should confirm the clearing action by displaying 0 in the left-hand display area.

Press: [=] [SHIFT] [BIN SUM] [0] [0] [1] [4]

f. Press: [MEASURE RATE] key to select MEDIUM rate.

Repeat the procedure of steps c, d, e (as summarized below), for this rate.

**Time** the interval between the next two keystrokes.

**Press:** [FUNCTION] key to select MEASURE function. Wait 60 seconds.

**Press:** [FUNCTION] key to select ENTER function.

**Press:** [SHIFT] [BIN SUM] [0] [1].

**Read** the left-hand display, the number of measurements made in 60 s.

**Use** this number as "x" in the following formula.

$$T = 60,000 \text{ milliseconds} / x$$

For example, if  $x = 250$ , then  $T = 240 \text{ ms} \pm 5\%$ .

**Clear** "bin sum" registers by pressing: [=][SHIFT] [BIN SUM] [0][0][1][4].

g. Press: [MEASURE RATE] key to select FAST rate.

Repeat the procedure of steps c, d, e (as summarized below), for this rate.

**Time** the interval between the next two keystrokes.

**Press:** [FUNCTION] key to select MEASURE function. Wait 60 seconds.

**Press:** [FUNCTION] key to select ENTER function.

**Press:** [SHIFT] [BIN SUM][0][1].

**Read** the left-hand display, the number of measurements made in 60 s.

**Use** this number as "x" in the following formula.

$$T = 60,000 \text{ milliseconds} / x$$

For example, if  $x = 493$ , then  $T = 122 \text{ ms} \pm 5\%$ .

**Clear** "bin sum" registers by pressing: [=][SHIFT][BIN SUM][0][0][1][4]

- h. Select "Max" measurement rate by pressing: [.] [2] [5] [=] [SHIFT] [SPECIAL] [5].  
 (Note: indicated measure rate must be FAST. For explanation, see paragraph 3.5.5.)  
 Repeat the procedure of steps c, d, e (as summarized below), for "Max" rate.

**Time** the interval between the next two keystrokes.

**Press:** [FUNCTION] key to select MEASURE function. Wait 60 seconds.

**Press:** [FUNCTION] key to select ENTER function.

**Press:** [SHIFT] [BIN SUM] [0][1].

**Read** the left-hand display, the number of measurements made in 60 s.

**Use** this number as "x" in the following formula.

$$T = 60,000 \text{ milliseconds} / x$$

For example, if  $x = 771$ , then  $T = 78 \text{ ms} \pm 5\%$ .

**Clear** "bin sum" registers by pressing: [=] [SHIFT] [BIN SUM] [0][0][1][4].

- i. Switch the Digibridge POWER OFF. Install the high-speed option board 1689-9620 carefully, as described in paragraph 5.5.5.

#### NOTE

After the power-up self checks, the Digibridge with high-speed option will automatically select TRIGGERED measurement mode.

- j. Repeat steps a through h, recording the results as before.

- k. If the calculated values of T in step j indicate a test-time reduction compared to the values of T in steps d through h, the high-speed-measurement option is functioning properly. Refer to Table 5-3 for typical values.

**Table 5-3**  
**EXAMPLES OF MEASUREMENT-TIME REDUCTION BY HIGH-SPEED OPTION**

Rate	Without H-S Option Example, steps d f g h		With H-S Option Example, step j		T Difference of Example	Normal Range of T Differ- ences
	x	T	x	T		
----- 1689 Digibridge -----						
SLOW	60	1000 ms	62	970 ms	30 ms	38 +/- 50 ms
MEDIUM	252	238 ms	300	200 ms	38 ms	38 +/- 20 ms
FAST	510	118 ms	750	80 ms	38 ms	38 +/- 10 ms
"Maximum"	1017	59 ms	1500	40 ms	19 ms	19 +/- 6 ms
----- 1689M Digibridge -----						
SLOW	62	968 ms	63	952 ms	16 ms	24 +/- 50 ms
MEDIUM	294	204 ms	333	180 ms	24 ms	24 +/- 20 ms
FAST	674	89 ms	923	65 ms	24 ms	24 +/- 10 ms
"Maximum"	1364	44 ms	1875	32 ms	12 ms	12 +/- 6 ms

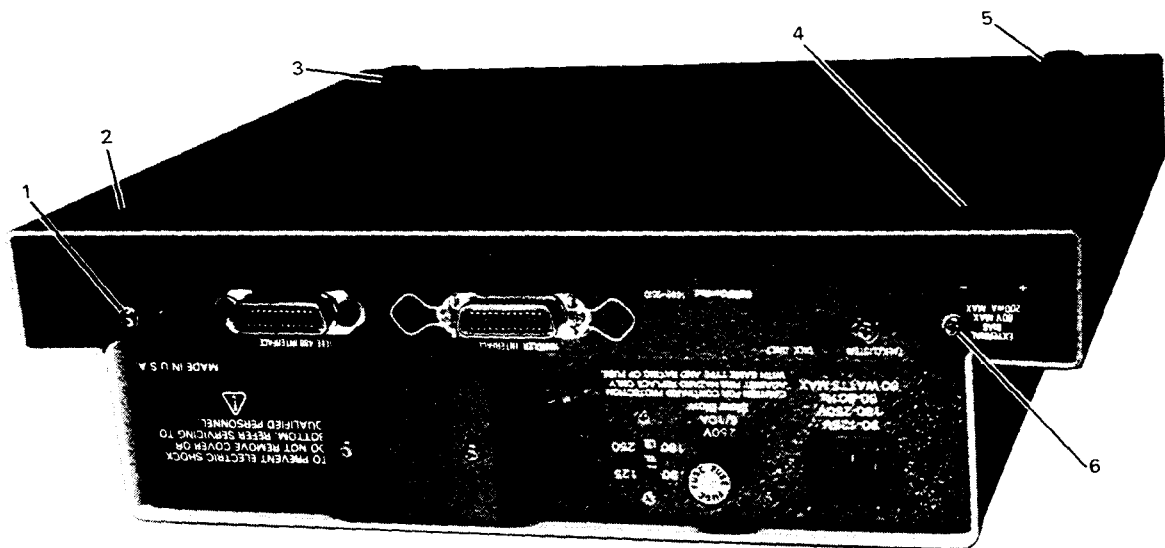

Figure 5-1. Rear and bottom view of the 1689 Digibridge, showing screw locations for disassembly: top-cover screws 1 and 6; bottom-shell screws 2, 3, 4, 5.

## 5.5 DISASSEMBLY AND ACCESS

### WARNING

If disassembly or servicing is necessary, it should be performed only by qualified personnel familiar with the electrical shock hazards inherent to the high-voltage circuits inside the cabinet. Be sure that you never short or apply voltage to the battery B1. (See para 5.7.3.)

### CAUTION

Observe precautions against damage by static electricity whenever you handle a circuit board or integrated circuit in this instrument. Refer to the beginning of Section 5.

### 5.5.1 Disassembly of 1689 Digibridge

Figures 5-1 through 5-9.

Use the following procedure for access to replaceable parts and contact points used in trouble analysis. (For disassembly of 1689M model, refer to paragraph 5.5.2.)

a. Disconnect the power cord.

b. Remove the top-cover screws from the rear panel of the main chassis. See Figure 5-1. (These screws are slightly outboard from the ones designated for interface option or cover plate. One of them is just to the right of the label EXTERNAL BIAS.) Slide the top cover forward about 6 mm so that its front corners are unhooked. Lift it directly upward (Figure 5-2). Reassembly note: Install the cover without air filter, using the 2 screws, 13 mm long. Then stuff the air filter into position through the air intake opening; using your fingers, press the edges and corners of the filter into position.

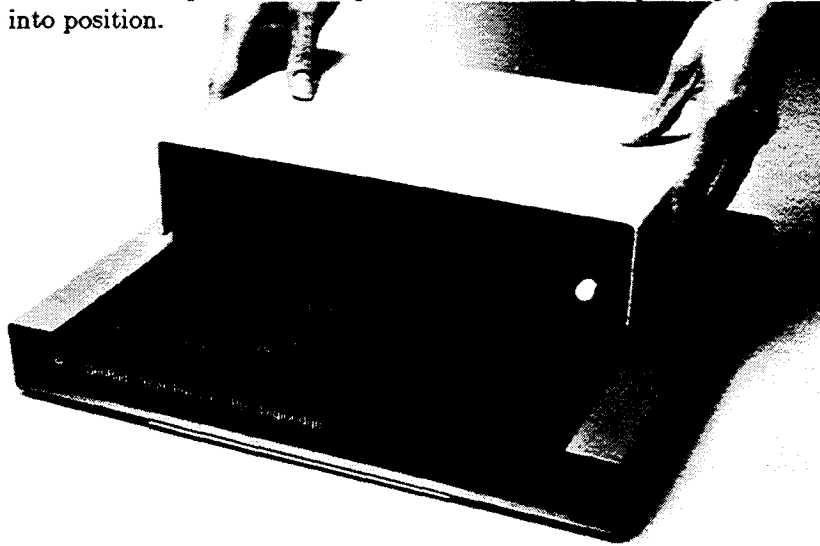

Figure 5-2. Removal of the top cover from 1689 Digibridge.

The next step, removal of display board, is recommended before removal of the main circuit board.

c. Remove the 2 support screws, Figure 5-3, that hold the display board to its brackets. Pull the board directly out of its socket in the main board. Keep the display board in its original (inclined) plane until it is completely free (Figure 5-4). Reassembly note: 2 screws, 6 mm long with washers.

d. Disconnect the ribbon cable (1689-0200) from main board (at connector J5). The cable can be removed from the power supply (J1) after removal of the protective cover as described below. Notice that the connectors are symmetrical; reversing either or both is permitted; and the cable is extra long, for convenience in servicing.

NOTE: The next two steps, removal of the power supply, are NOT related to the removal of the main board. Either can be left in place while the other is removed.



## WARNING

Dangerous voltages are present on wires and terminals that will be exposed in the following steps. BE SURE THAT THE POWER CORD IS DISCONNECTED BEFORE PROCEEDING.

- e. Remove the protective cover (with the warning label) from the upper right portion of the power supply (3 screws).

## CAUTION

In reassembling, inspect carefully to be sure that none of the nearby wires touches the fan rotor or blades. Inspect by looking under the 1657-4720 board. To verify free rotation, blow on the fan and watch it spin.

- f. Remove the five screws that fasten the bottom of the power supply to the main chassis. Four screws are at corners of power supply; the fifth is nearly hidden, between the transformer and the largest capacitor. Lift the power supply slightly and move it back carefully while disengaging the POWER pushbutton extension from its hole in the front panel (Figure 5-5). Reassembly note: 5 screws, 8 mm long.



Figure 5-3. Power supply (V assembly) and display (or DB) board, shown in the 1689 Digibridge, with top cover off. The protective cover has been removed from above the 1657-4720 board.

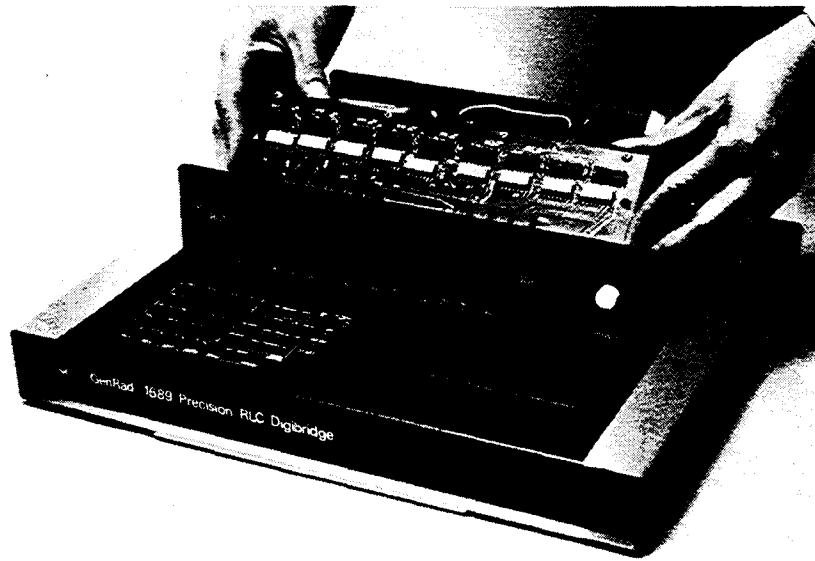

Figure 5-4. Removal of the display board from the 1689 Digibridge.

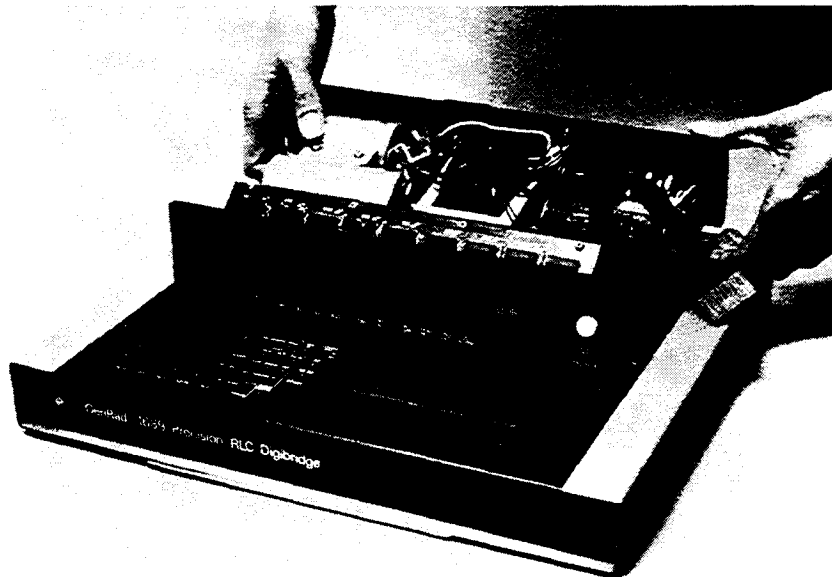

Figure 5-5. Removal of the power supply from the 1689 Digibridge. The ribbon cable must be disconnected first. The display board can be removed first or left in place as shown here.

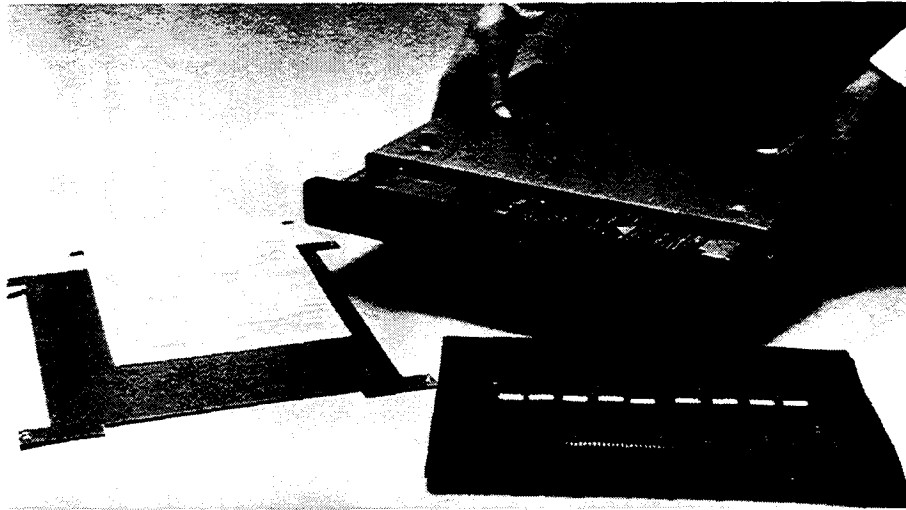

Figure 5-6. Removal of the bottom shell from the 1689 Digibridge. Notice that the top cover has been temporarily installed as a support.

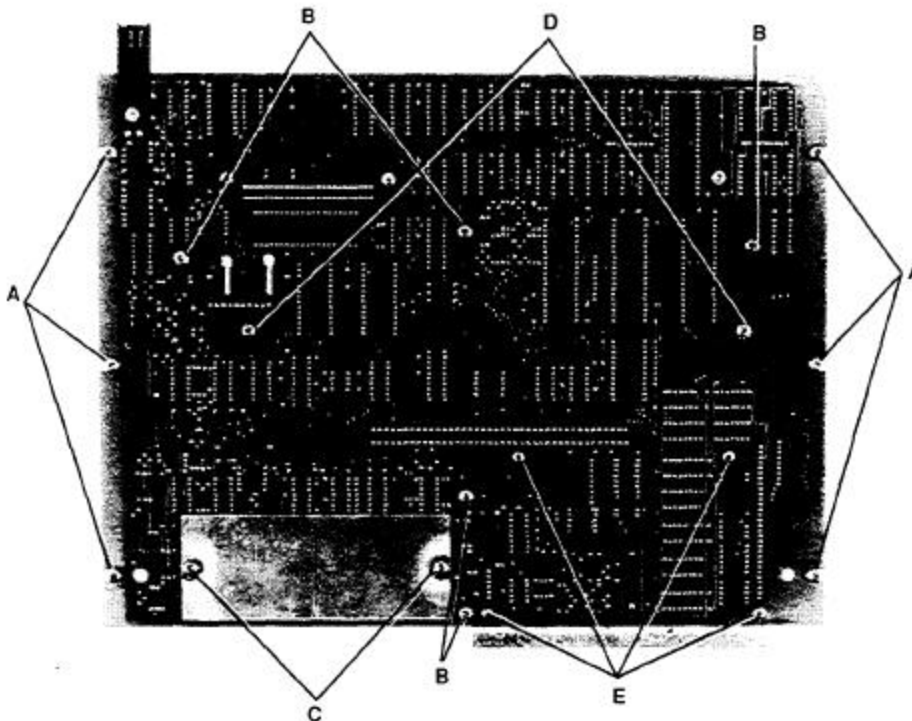

Figure 5-7. Locations of screws on the main board of the 1689 Digibridge, bottom view. Screws at A and d hold the board to the chassis. Screws at C hold a shield and (with 2 screws from the other side) the test fixture assembly. Screws at D hold brackets for the display board; and at E, the keyboard module.

g. Remove the interface option, if you have one, after removing the 2 large screws with resilient washers in the rear panel. See Figure 1-2. (If the panel held by these screws is blank, leave it in place.) Reassembly note: align board edges carefully with connector and guide that are inside of instrument, while pushing interface option into position.

h. After disconnecting the ribbon cable (step d), provide a convenient "up-side down" support by reinstalling the top cover, temporarily. Turn the instrument, bottom up.

i. Remove 4 screws from the bottom shell, one near each rubber foot (Figure 5-1). Lift the instruction card and its retaining pan free. Slide the bottom shell back (or forward), free of the main chassis (Figure 5-6). Reassembly notes: Be sure to enfold the pliable dirt seals at left and right sides of main chassis as you start to slide bottom shell onto main chassis; use 4 screws, 8 mm long.



Figure 5-8. Removal of the main board from the 1689 Digibridge. The ribbon cable must be disconnected first. Prior removal of the display board also is highly recommended. Because the board is partially enclosed by the main chassis, unusual care may be needed in removal. These motions are suggested: slide toward the rear, tilt as shown, and gently lift free.

j. Remove 11 screws from positions shown in Figure 5-7 as A and B, to free the main board. Lift slightly, and slide the board rearward so the keyboard can be lifted past the lip of the chassis. Tilt the front edge up about 6 cm (2 in.) before lifting the whole board out. Figure 5-8 shows how to tilt the main board to the best position for removal. Reassembly note: return washers to original positions; A screws are 6 mm long, B screws are 8 mm long.

k. To remove the keyboard module, remove the 4 screws at E (Figure 5-7) and carefully pull the module directly away from the main board. Reassembly note: be very careful not to bend pins when plugging the keyboard-module connectors into their main-board sockets; use 4 screws, 6 mm long.

1. For access to the test-fixture contacts, remove the dross tray 1657-7700 (the plastic dirt catcher) by spreading it slightly and lifting it off. Then remove the guide block assembly 1689-2000 (includes dross tray) by removing 2 screws and associated washers, spacers and shield plate, on bottom of main board (see "C", Figure 5-7) and 2 test-fixture center shield screws (use hexagonal wrench 2.38 mm = .094 in.) from top of the main board. (See also Figure 5-9.)

Reassembly note: C screws are 13 mm long. Position the guide block assembly for smooth entry of a radial-lead DUT before tightening screws. If an extension cable is available, its paddle boards can be used for a centering jig. Otherwise verify by eye, looking directly down on the board, through the slots in the guide block, to the contact gaps.

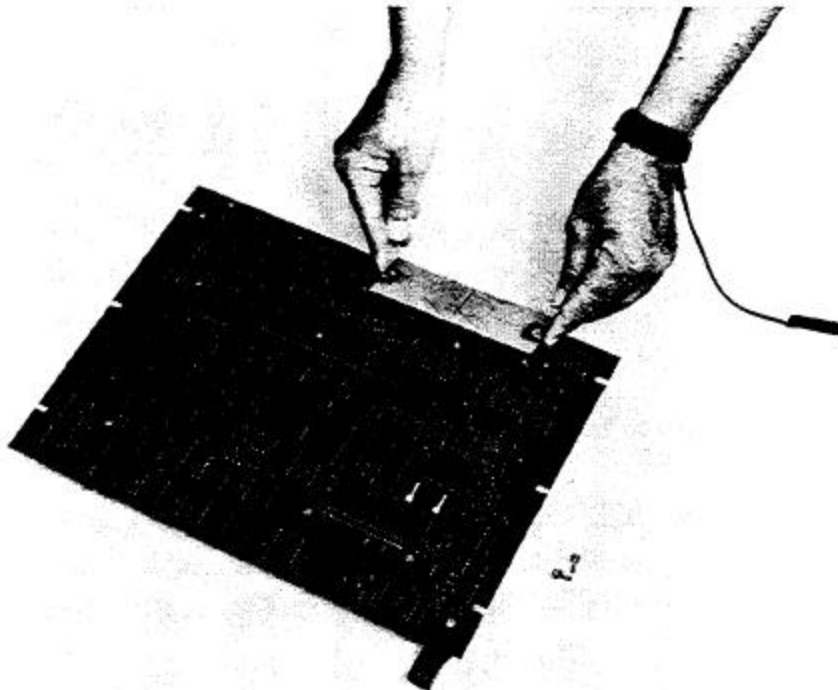

Figure 5-9. Removal of the shield from below the test fixture of the 1689 Digibridge. Notice the use of a personnel grounding strap.

### 5.5.2 Disassembly of 1689M Digibridge

### Figures 5-10 through 5-12.

Use the following procedure for access to replaceable parts and contact points used in trouble analysis.

- a. Disconnect the power cord. Optionally, remove the bail from the front feet by bending it temporarily. (It is springy enough to resume its former shape.)
- b. For access to the bottom of the main board, without further disassembly, remove the access panel from the bottom of the instrument. Note: this panel is held by ten screws and covers a major part of the bottom area.
- c. Remove the four rubber or plastic feet (one screw for each rear foot, two screws for each front foot). Notice that the front feet are *not* interchangeable.

d. Remove the foam-plastic air filter from its holder, in the right side of the cabinet. (Reassembly note: Stuff the air filter into position through the air intake opening; using your fingers, press the edges and corners of the filter into position.)

e. Slide the instrument forward (or cover to the rear) until they are separated. (Reassembly note: slide the cover on until the rear feet mounting holes in the cover are aligned with corresponding holes in the chassis.)

f. Remove the interface option, if you have one, after removing the 2 large screws with resilient washers in the rear panel. See Figure 1-2. (If the panel held by these screws is blank, leave it in place.) Reassembly note: align board edges carefully with connector and guide that are inside of instrument, while pushing interface option into position. Refer also to paragraph 5.5.5.

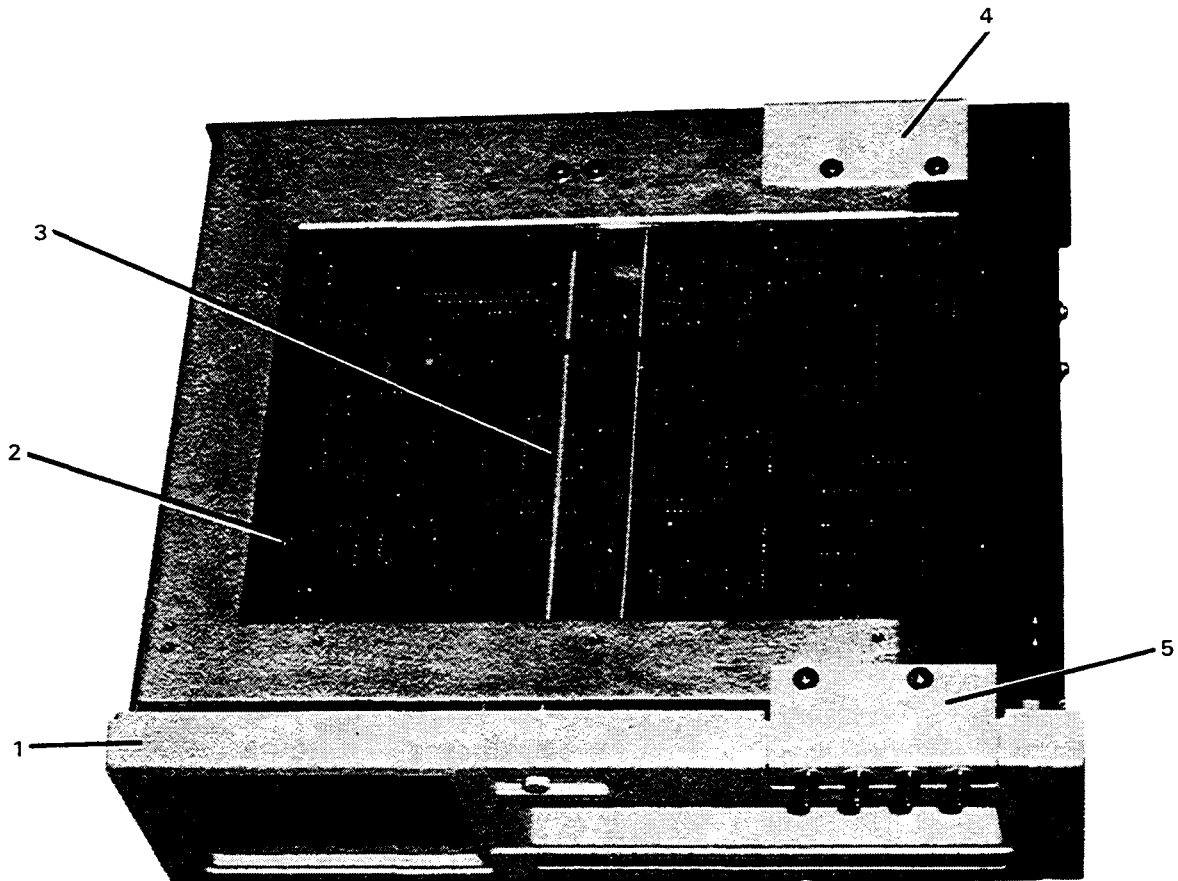

Figure 5-10. Bottom view of 1689M Digibridge with access panel and cover removed.

- |                                      |  |
|--------------------------------------|--|
| 1. Front panel assembly.             | 4. Blank bracket at rear "BNC" position. |
| 2. Main board.                       | 5. BNC connector bracket at front.       |
| 3. Push rod for POWER ON/OFF switch. |  |

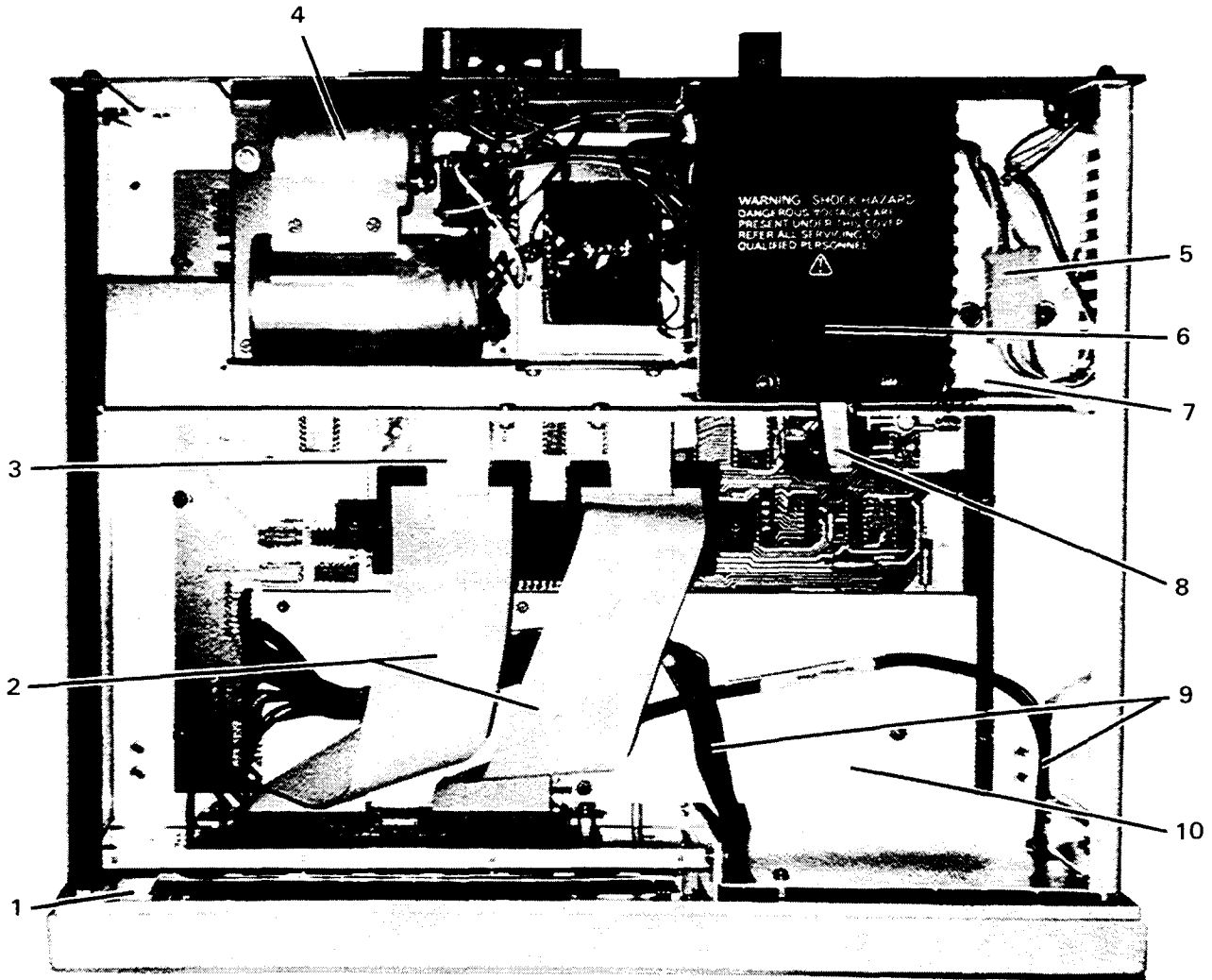

Figure 5-11. Interior top view of 1689M Digibridge, with cover removed.

- |                                    |                                    |
|------------------------------------|------------------------------------|
| 1. Front panel assembly.           | 6. Protective cover.               |
| 2. Ribbon cables to display panel. | 7. Air deflector.                  |
| 3. Retainer for cable connectors.  | 8. Ribbon cable from power supply. |
| 4. Power supply.                   | 9. Ribbon cables to keyboard.      |
| 5. A-c power connector.            | 10. Shield plate.                  |

g. For access to the desired areas on top of the main board, do as much of the following as needed:

**Unplug** the cables.

NOTE: For reassembly, be sure that the keyboard cables are both oriented with color marked edges *up* at the keyboard and *toward the rear* at the main board. Similarly, the two display-board cables must not cross or twist.

**Remove** the shield plate (four screws).

**Remove** the power supply as follows.



## WARNING

Dangerous voltages are present on wires and terminals that will be exposed in the following steps. **BE SURE THAT THE POWER CORD IS DISCONNECTED BEFORE PROCEEDING.**

- (1) Unplug the ribbon cable leading from power supply to main board (at J5).
- (2) Remove the protective cover (with the warning label) from the upper right portion of the power supply (3 screws).
- (3) Disconnect a-c power connectors (from each other) in the cable at right of power supply (cable leads to ON/OFF switch). NOTE: the cable may be shorter and the connectors found farther to the left than pictured.
- (4) Remove five screws that fasten bottom of power supply to the bracket below. Four screws are at corners of power supply; the fifth is nearly hidden, between the transformer and the largest capacitor.

## CAUTION

In reassembling, inspect carefully to be sure that none of the nearby wires touches the fan rotor or blades. Inspect by looking under the 1657-4720 board. To verify free rotation, blow on the fan and watch it spin.

h. For access to the display board, keyboard, and other parts in the front panel assembly, unfasten it from the chassis, as follows.

NOTE: The obvious parts of this assembly are the plastic bezel (at the very front), the subpanel (to which the other parts are attached), the display board, the display window in front of the board, and the keyboard module. Behind and below the display board is the display connector board. Behind the keyboard is the keyboard mount (a wide bracket with clearance holes for cables).

**Remove** the access panel from the bottom. (See above.)

**Remove** the two screws from the BNC-connector bracket (or blank bracket), whichever is at the front.

**Disconnect** the cables from display and key boards. (See above.)

**Place** a small spacer (such as a pad of paper) under the chassis at each side, but *not* under the front panel assembly.

**Remove** four screws (2 at left, 2 at right) that pass through the sides of the chassis (just behind the rear edge of the bezel) into flanges of the subpanel. Pull the front panel assembly forward and tilt it face down.

Notice that moving the bezel forward leaves the POWER ON/OFF push rod unsupported at the front. For reassembly, be sure to check that this push rod is attached (via a short piece of rubber tubing) to the power switch. Guide the front end of this rod through its hole in the bezel while bringing the front panel assembly into position. (The bottom access panel should be out of the way during this procedure.)

Notice also that (if the BNC connector bracket is at the front) its shielded cables must be kept to the left of the display-panel connector board during reassembly (to avoid pinching the cables).

i. To remove the keyboard module:

**Remove** the four screws (all with their heads to the right) that hold the keyboard assembly to the subpanel at the right and the keyboard bracket at the left. Remove this assembly.  
**To separate** the keyboard, remove 4 screws that pass through the mounting plate.

Reassembly note: be sure that all keys and switches of the keyboard are properly located in their holes in the subpanel before tightening the four screws in the subpanel and bracket. Also, plug the two cables into the keyboard before attaching the front-panel assembly to the chassis. **IMPORTANT:** each of these cables plugs onto a row of pins, without any keying. Be sure that the cable is oriented correctly (with color marked edges *up* at the keyboard and *toward the rear* at the main board. *Also* be sure that each cable connector engages its full set of pins and does NOT miss the first or last one.

j. To remove the display board:

**Remove** the two screws that pass through the display board, into spacers on the subpanel (not the two screws that fasten the associated connector board).  
**Slide** the display board upwards, to unplug it from the connectors below.

k. To remove the main board:

**Disconnect** the cables that connect this board with display, keyboard, and power supply. (See above.)  
**Remove** the two screws from below that attach the BNC-connector bracket (at front or rear panel).  
**Remove** the eight screws from above that fasten the main board to the chassis and the stiffener below this board. Note: one of these screws is accessed after first removing the air deflector (2 screws) near the right rear air vent.  
**Remove** the main board, forward and upwards. If removal is obstructed by the front-panel assembly, that can be removed first. (See above.)

### 5.5.3 Relocation of BNC Connector Bracket (Test Signal Interface Port) on 1689M

The BNC connectors that provide interface (via cables) to the DUT test fixture can be located at the lower part of either front or rear panel. The four BNC connectors remain mounted on their bracket and cabled to the main board during relocation from front to rear, or vice versa. To relocate this bracket from front to rear:

a. Disconnect the power cord. Remove the bail from the front feet by bending it temporarily. (It is springy enough to resume its former shape.)

b. Remove the access panel from the bottom of the instrument. Note: this panel is held by ten screws and covers a major part of the bottom area.

c. Loosen generously (but do *NOT* remove) the two right-side screws that fasten the front-panel assembly into the chassis. Stand the instrument on its right side. Remove the two left-side screws that are opposite to the ones just loosened. Now the front-panel assembly can be tipped away from the instrument an inch or two (as required in the next step). Note the display and keyboard cables remain connected.

- d. Remove the blank bracket (2 screws) from the rear BNC-contractor position.
- e. Remove the two screws that fasten the BNC connector bracket to the main chassis, below the front panel.
- f. Holding the front-panel assembly tipped away from the instrument slightly, snake the BNC connector bracket between the main board and the nearby part of the chassis, until free from its front position. Return the front-panel assembly to its normal position and secure it with its two screws. Refer to Figure 5-12.
- g. Snake the BNC connector bracket carefully into the rear position (where the blank bracket was). Handle the shielded cable assembly with care and be sure that it is dressed neatly, with a minimum of twist or stress in its new position.
- h. Fasten the BNC connector bracket in the rear position and the blank bracket in the front position.
- i. Reassemble the instrument and verify normal operation.

To relocate the BNC connector bracket to the front again, reverse this procedure.

#### **5.5.4 Access to Internal Components**

**(See Figures 6-4,6-5.)**

*Main Board.* Locations of principal interior parts and points of interest for trouble analysis are shown in Section 6 layout drawings (Figures 6-4, 6-5). The analog circuitry is placed along the front (forward of the display-board connector) and along the front half of the right-hand edge. However, most of this board supports digital circuitry.

*Power Supply.* For access to parts in the power supply, refer to Section 6.

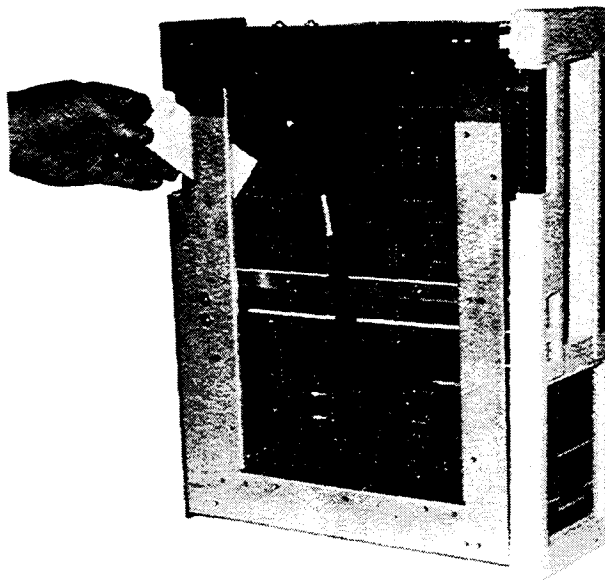
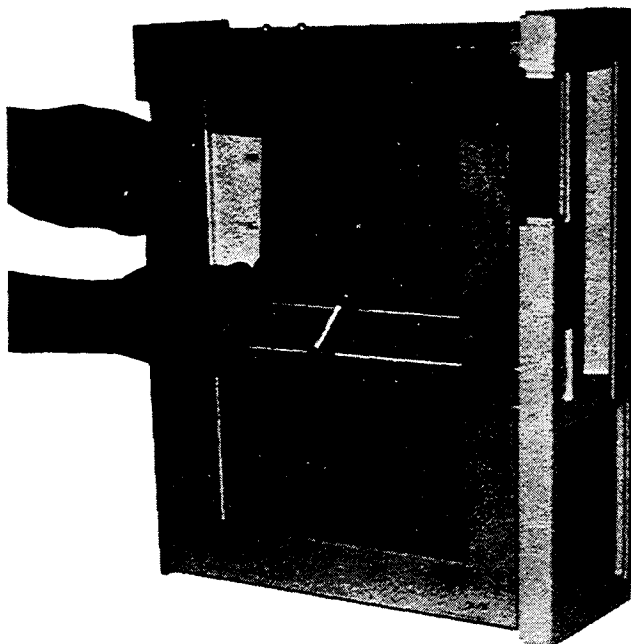
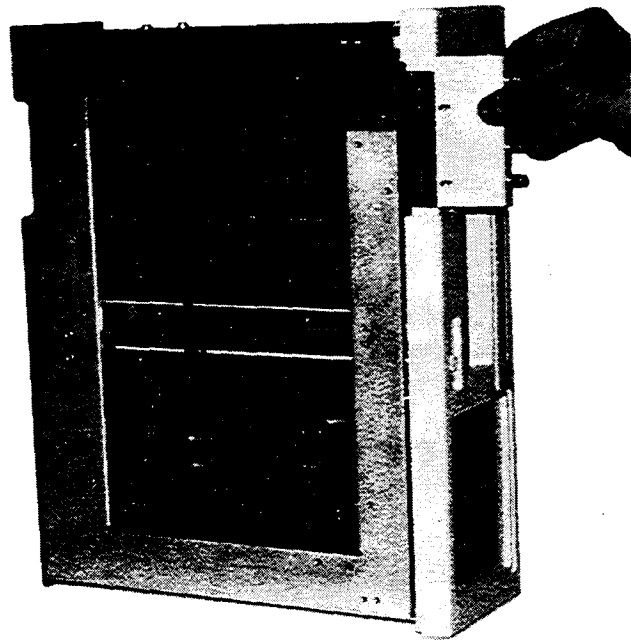

Figure 5-12. How to snake the BNC connector bracket from its front position to its rear position. It is important to proceed carefully because of tight clearances and the presence of many sharp tips of wire that can interfere.

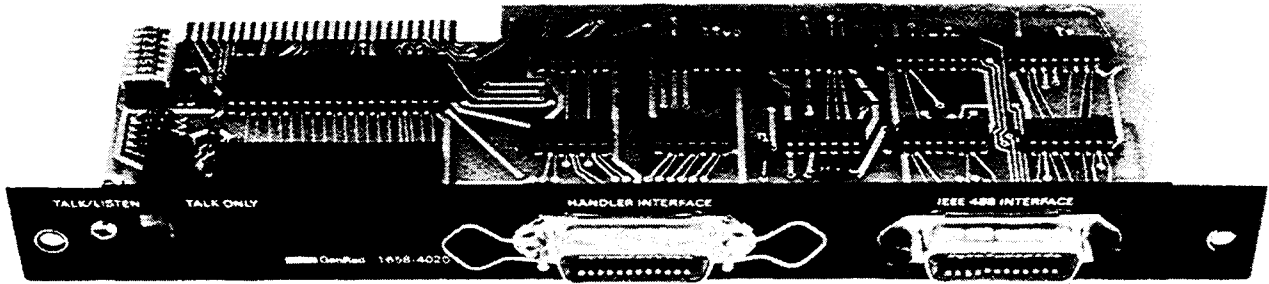

Figure 5-13. IEEE/handler interface option assembly 1658-9620, including the interface option board (IOB) 16584620.

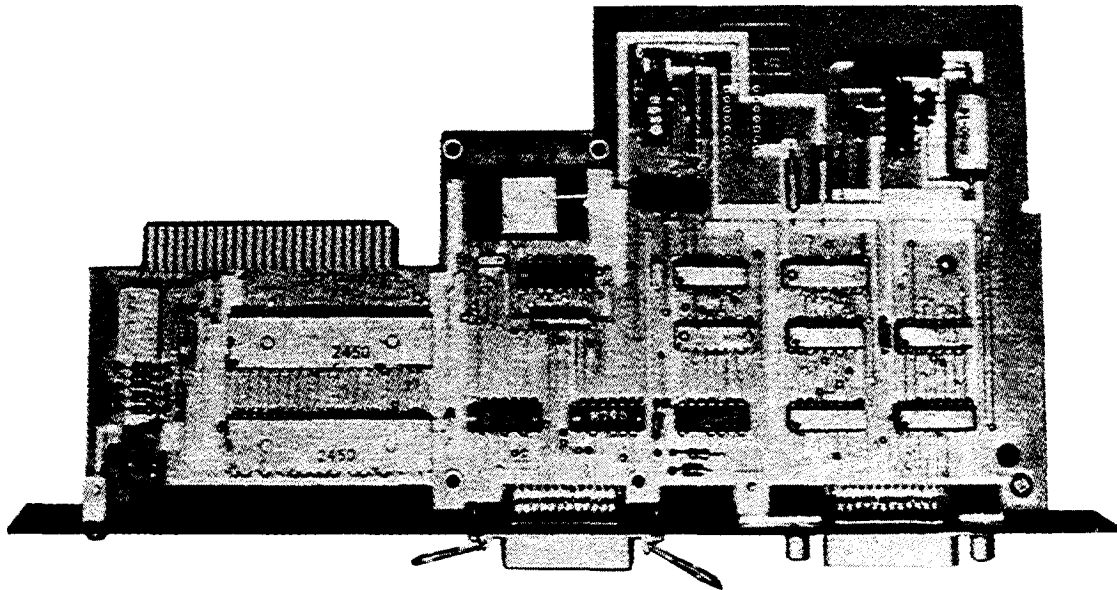

Figure 5-14. High-speed measurement and IEEE/handler option 1689-9620, including the 1689-4620 circuit board.

### 5.5.5 IEEE/Handler Interface Options

Figure 5-13.

This Digibridge accepts either of two options that provide both IEEE-488-bus and handler interfaces. Refer to the Specifications in the front of this manual and to Table 1-3 in Section 1.

*Removal of Interface Board.* The procedure is the same for either option and either Digibridge:

- a. Switch POWER OFF and disconnect power cord from Digibridge.
- b. Place the instrument in the normal position (flat on table or in rack). Looking at the rear panel, remove the two screws that hold the interface-option's rear panel (or the blank cover plate) from the Digibridge. Refer to Figures 1-3 and 1-4, in Section 1.

- c. Withdraw the interface option (or the cover plate) horizontally, directly away from the front panel.

### CAUTION

Observe precautions while handling the interface option. Because there are static sensitive parts on the board, DO NOT TOUCH THE CIRCUITS or ICs. Refer to Section 5 of this manual, for recommended handling procedure.

*Installation.* Install or reinstall the interface option as follows.

- a. Hold the interface option by its rear panel, so that the labels near the connectors read "right-side up".

*Look through the opening into the instrument and observe the connector that will receive the interface option board's edge contacts.* Insert the board *horizontally* through the opening, with care to align the board-edge contacts with the mating connector inside.

- b. Press the interface option fully into the Digibridge by hand, confirming that alignment is correct. Reinstall the screws that were removed in step b, above.

## 5.5.6 Removal of Multiple-Pin Packages

Use caution when removing a plug-in integrated-circuit or other multiple-pin part, not to bend pins nor stress the circuit board. Withdraw the part straight away from the board. Unless an IC is known NOT to be a static-sensitive type, place it immediately on a conductive pad (pins in the pad) or into a conductive envelope.

DO NOT attempt to remove a soldered-in IC package unless you have the proper equipment and skills to do so without damage. If in doubt, return the board to GenRad.

## 5.6 PERIODIC MAINTENANCE

### 5.6.1 Care of the Test Fixture

For best results and minimum maintenance effort, the operator must remove any obvious dirt from leads of DUTs before inserting them into the test fixture. Its contacts will wipe through a film of wax, but they can become clogged and ineffectual if the operator is careless about cleanliness.

About once a year (more or less depending on usage) the test fixture and its axial-lead adaptors should be inspected and cleaned as follows:

- a. Clean the contact surfaces and blades of the axial-lead adaptors with isopropyl alcohol. Rub with a cotton swab (Q-tip). Remove any remaining liquid alcohol by blowing with the breath and remove any remaining cotton fibers, with tweezers.
- b. Expose the test fixture contacts for cleaning as follows (depending on which test fixture is being cleaned).

Test Fixture Included On 1689 Digibridge. Remove the main board and expose the test-fixture contacts by removing its guide block assembly (part number 1689-2000), as described in paragraph 5.5.1 and repeated here for convenience.

Remove the dross tray 1657-7700 (the plastic dirt catcher) by spreading it slightly and lifting it off.

Carefully remove the guide block assembly (part no. 1689-2000, includes dross tray) by removing 2 screws and associated washers, spacers and shield plate, on bottom of main board (see "C", Figure 5-7) and 2 test-fixture center shield screws (use hexagonal wrench 2.38 mm = .094 in.) from top of the main board. (See also Figure 5-9.)

Reassembly note: C screws are 13 mm long. Position the guide block assembly for smooth entry of a radial-lead DUT before tightening screws. If an extension cable is available, its paddle boards can be used for a centering jig. Otherwise verify by eye, looking directly down on the board, through the slots in the guide block, to the contact gaps.

#### **1689-9600 Test Fixture (the one without a START bar).**

**Remove** the four rubber feet (one screw apiece) and slide the bottom housing off.

**Remove** the two hex socket head screws near the middle of the circuit board (top side; use hexagonal wrench 2.38 mm = .094 in).

**Remove** the two screws and associated washers near the right and left ends of the circuit board (bottom side).

**Carefully remove** the guide block assembly (part number 1689-2000).

Reassembly note: See above.

#### **1689-9605 Test Fixture (the one with a START bar and GO/NO-GO lights).**

**Remove** the four rubber feet (one screw apiece) and slide the base off.

**Remove** the two hex socket head screws near the rear, along the front--to-back midline of the circuit board (top side; use hexagonal wrench 2.38 mm = .094 in).

**Remove** the two screws and their washers, below the right and left ends of the test-fixture guide block, taking care not to lose the spring under the START bar, which will become free.

**Carefully remove** the guide block assembly (not available as a replacement part), which includes the START bar, and which is tethered to the circuit board by a ground wire.

Reassembly note: See above.

c. Clean and check the 4 contact strips. Use a card wet with isopropyl alcohol for cleaning. Hold the board at an angle so that any drip falls away from the circuits.

d. *If necessary for better access for cleaning*, remove 2 front contacts (P IN 1689-1015). Use a hexagonal wrench (2.38 mm, .094 in.) to remove 2 screws per contact. Reassembly note: gap between contacts should not exceed 0.24 mm (.009 in., or the thickness of 3 layers of typing paper); and contacts must press against each other (insulated by tiny dielectric spacers attached near each end of slot) so that a wire of 0.64 mm diameter (AWG 22, .025 in.) can be withdrawn from between them with a force of 1 (minimum) to 2 (maximum) newtons (100 to 200 grams). Tighten the hex-drive screws with a torque of 1.3 to 1.4 newton-meters (12 in-lb).

#### CAUTION

Because of alignment difficulty in reassembly,  
DO NOT use the next step unnecessarily.

e. *If necessary*, remove the 2 remaining contacts as in the previous step. Reassembly note: align the contacts so that the surfaces that will press against the DUT leads are collinear (so that the guide block can be positioned with its slots matching the gaps in BOTH contact pairs); tighten hex-drive screws as specified above.

## 5.6.2 Cleaning the Air Filter

About once a year (or more often in dusty environments) clean the air filter as follows. The air filter is a spongy piece of plastic found in the air intake vent on the right side of the Digibridge. (See Figure 6-1.) Pull the filter out with your fingers or pliers. Wash it thoroughly in warm water and a mild detergent. Rinse. Squeeze the water out and let it dry completely. Then stuff the air filter into position through the air intake opening; using your fingers, press the edges and corners of the filter into position.

## 5.6.3 Care of the Display Panel

Use caution when cleaning the display window, not to scratch it nor to get cleaning substances into the instrument. Use soft cloth or absorbent cotton, moistened with a mild glass cleaner, such as "Windex" (Drackett Products Co., Cincinnati, Ohio). DO NOT use a paper towel; do NOT use enough liquid to drip or run.

If it should be necessary to place marks on the window, use paper-based masking tape (NOT any kind of marking pen, which could be abrasive or react chemically with the plastic). To minimize retention of any gummy residue, remove the tape within a few weeks.

## 5.7 TROUBLE ANALYSIS

### 5.7.1 General

#### CAUTION

Only well qualified personnel should attempt trouble analysis. Be sure power is OFF during disassembly and setting up for tests. Carefully observe the HANDLING PRECAUTIONS given at the beginning of Section 5.

*Resources.* Refer to Section 4 for a good understanding of the theory of operation. The block diagrams and discussion there provide necessary background, which can generally save time in trouble analysis. Refer to Section 6 for hardware details: circuit layouts, schematic diagrams, and parts lists.

*Abnormal digital Signal levels.* Most digital signal levels in this instrument are normally near zero (logic low), about +3.5 to +5 V (logic high), or rapidly switching between these states. Failure of a digital source often produces a dc voltage of about +2 V on a signal line. Use high-impedance probes in measuring. Use a scope as well as a voltmeter, because an average of 2 V may be normal for a digital signal that has a duty cycle near 50%.

*Duplicated circuits and resistor networks.* Some circuits, as in the display board for example, are duplicated several times. The ICs can usually be exchanged between a faulty circuit and a functional one, to identify a "bad" IC. Notice, also, that the resistor networks DB-Z2...DB-Z10 are simply compact packages of 220-ohm resistors. If one resistor is open, it is not necessary to replace the entire package. Use a 5% resistor.

*Circuit board replacement.* Refer to paragraph 5.3 for recommended procedures to obtain replacements.

*Power-Up Self Check.* Upon power-up, the Digibridge performs a self-check sequence as explained in paragraph 3.13. If a self-check failure occurs, the instrument display will indicate the nature of the failure. For more detail refer to paragraph 5.7.2 below.



*Telltale symptoms.* Scan the following group of symptoms for a preliminary analysis of trouble and suggestions for more detailed procedures if applicable.

**Display.** A perpetually blank digit or decimal point may be caused by a fault in the directly associated circuit on the display board. (Refer to comments above.)

**D Error.** A large D error may be caused by faulty "protection" diodes in the analog front end. Check main board components CR30, CR31, CR32, and CR33.

**Reactance Error.** If Cor L measurements are not accurate, the test signal source may be at fault. In checking it, verify that the frequency is within +/- 0.01 % of the specified nominal frequency. Refer to paragraph 3.4.1.

**Keyboard Malfunction.** If instrument passes its power-up self check and proceeds to measure BUT has no (or only a few) keyboard indicators lit, and the keys on the keyboard don't function normally: the fault is probably in the 30-wire cable connection between keyboard and main board. *If* the keyboard has been disconnected, check for misalignment of the connector that plugs directly into the keyboard. If only one key or indicator malfunctions, check that portion of the keyboard.

**Test Signal.** To check performance of the test-signal source, use a scope to look at the open-circuit signal at the I<sub>h</sub> terminal of the test fixture (right front contact ---be sure there is no DUT). The signal on each range should be an undistorted sine wave at the selected frequency, with the top of the waveform about +3.4 V and the trough about +0.85 V.

**Analog Front End and Detector.** To check the entire analog front end, install any typical DUT in the test fixture, select the default test conditions (including CONT MEASURE MODE) by switching POWER OFF and ON. (The keyboard must not be locked.) Use an oscilloscope to look at the signal at the instrumentation amplifier output (main board, U61 pin 14). This waveform should switch back and forth between two 1-kHz sinewaves whose amplitudes are proportional to the voltages across the DUT and the internal standard resistor. If the DUT is an open circuit or a short circuit, this signal should switch back and forth between a very small ac signal and a 6.8 V pk-pk ac signal. If these signal levels are incorrect or the signals are distorted, the problem is either in the sinewave generator or in the analog front end. Check this waveform with known "problem" test conditions. If this signal appears to be correct, use an oscilloscope to verify that the signal at main board, U64 pin 7 has the characteristic staircase/sawtooth waveform illustrated in Figure 5-15. If this is true (and if similarly normal waveform appears even when you select known "problem" test conditions), the fault is probably NOT in the analog detector.

**Introduction to Detailed Analysis.** The following trouble analysis procedures will serve as a guide for localizing a fault to a circuit area. In some cases, a specific component part can be isolated for replacement. In other cases, the problem can be narrowed down only to a circuit board.

Except for the short-cuts indicated above, follow the procedure strictly in the order given, doing the principal steps (a, b, c, d,...) until a failure is found. If so, do the secondary steps, if any are given at the point of failure (1, 2,3...).

#### NOTE

Reference designators, such as MB-U21, are frequently abbreviated in the following text, for example U21, because the context of the service procedure should leave no doubt as to which board is being serviced.

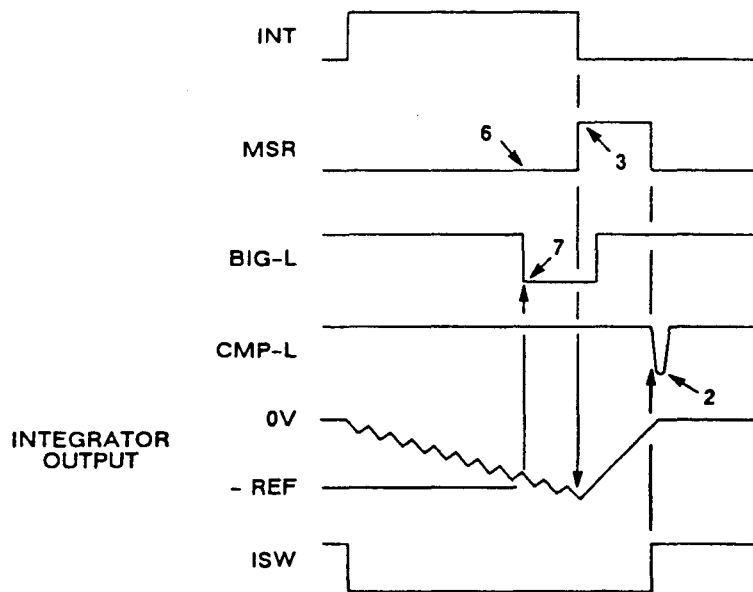

60041.0

Figure 5-15. Timing diagram for the detector portion of the power-up self-check, with keys to the crucial events that are checked. Labels 7 thru 1 correspond to tests identified with displays of 77777 7777 thru 77777 1111, respectively. When the instrument is making measurements, the waveforms are different in many details.

### 5.7.2 Power-Up Self Check and Certain Aborted Measurements

Figure 5-15.

The following outline of failure displays includes comments on some of the self check routines, significance of the displays, and some suggestions for appropriate service procedures.

#### GENERAL NOTES

For the most rigorous self check, in servicing, repeat the power-up self check several times, at least once with a short circuit as "DUT" in the test fixture and once with the test fixture empty (open circuit). A normally functional Digibridge should pass both ways.

Keen observation of the fleeting displays associated with the tests that pass, before the one that fails, are sometimes useful. Pressing any key, such as [SHIFT] will halt the self-test routine and hold the display until the key is released. Look for trends or tests that pass only marginally.

#### SELF-CHECK (FAILURE) DISPLAYS

88888888. RAM read/write exercise failure; Digibridge hangs up. PROCEDURE: Switch POWER OFF and ON to clear hangup and repeat self check. Check RAM circuitry and data and address buses.

77777 XXXX. Detector test failure; Digibridge hangs up. PROCEDURE: Switch POWER OFF and ON to clear hangup and repeat self check. He sure that the EXTERNAL BIAS switch is OFF. Use scope to check waveforms on the main board as indicated below and in the accompanying figure.

77777 7777. DBIG (U27 pin 2) is stuck low. Integration failure. PROCEDURE: check integrator output (U64 pin 7). Its acquisition, i.e. integration slope (downward) should cross the level of -5.1 V; then BIG-L (U64 pin 14) should go low and DBIG high, signaling the microprocessor to start conversion, i.e. deintegration.

77777 6666. DMSR (U27 pin 8) is stuck high. Integration failure. PROCEDURE: check MSR (U45 pin 11). Both of these signals should be low during integration. Check the circuit back through D flip-flop U45 to PMSR at U27 pin 10.

77777 5555. FCOUNT is not toggling (U27 pins 9, 40). Check the circuit back to frequency multiplexer U19 pin 9. Verify that all frequencies are present on the inputs to the multiplexer and that the control

lines FDIVO and FDIV1 are functioning (U19 pins 2, 14, respectively).

77777 3333. DMSR (U27 pin 8) is stuck low. Integration failure. PROCEDURE: Check MSR (U45 pin 11). Both of these signals should go high, starting the deintegration.

77777 2222. CMP-L (U64 pin 8) is stuck high. Deintegration failure. PROCEDURE: check that integrator output (U64 pin 7) rises to cross the 0-V level at the end of deintegration. CMP-L should go low at that crossing, and may remain low for only a brief pulse. The leading edge should cause DMSR to go low and ISW (U45 pin 6) should go high.

77777 1111. DBIG (U27 pin 2) is stuck high. Deintegration failure. PROCEDURE: verify that BIG-L goes high and DBIG goes low when integrator output becomes more positive than -5.1 V.

66666 XXXX. Detector scale factor and zero bias test failure; the Digibridge will loop, automatically repeating the test and updating the display. XXXX is the magnitude of "zero" measurement, normalized to 1.

COMMENT: The "zero" measurement includes a sequence of five dual-slope conversions (measurements of voltage coming into the detector from the instrumentation amplifier). Frequency is 1 kHz; test signal level is 75 mV. The signal component is removed by averaging the results of two dual-slope conversions, sampled in opposite phases. The detector is supposed to be biased so that its "zero" output is essentially in the center of its operating range. For convenience, the CPU divides the "zero" measurement by its normal value and displays the result. Consequently, the ideal value for XXXX is 1.000. If it is less than 0.875 or more than 1.125, the test fails.

ANALYSIS PROCEDURE: Check the following circuits:

1. Zero (half-scale) bias current circuit (CR38, R116).

NOTE: R116 is a 10-kilohm potentiometer, which should be adjusted for 2.5 V measured at the cathode of CR38. These components are found about 93 mm

(3 5/8 in.) from the right front corner, measured toward center of board.

2. Detector scale (integrator) current circuit (CR40, R119, U63).

3. Phase control circuit (U26, U27, U21, U23, U18, U22).

4. Detector switches (U63).

555 D XXXX. Signal strength check failure; the Digibridge will loop, automatically repeating the test and updating the display. The digit D indicates the range and voltage level used. (See below.) Test frequency is 1 kHz.

COMMENT: Possible cause is having EXTERNAL BIAS switch ON during power-up. The effect depends on what is connected to the EXTERNAL BIAS connector and what is in the test fixture. This switch must be OFF to assure normal power-up routines, also, check to make sure that the charged capacitor protective fuse has not blown (Item 11, Figure 1-3), the effect is similar. The Digibridge separately squares the measurements of 4 component voltages, a quadrature pair across the DUT and a pair across the internal standard resistor. The squares are summed to represent the square of the applied voltage (essentially the open-circuit voltage from the

HIGH terminals of the test fixture to ground. To normalize this result, it is divided by the square of the "zero" measurement. (See 66666 XXXX, above.) The ideal value for XXXX is about 0.64. If it is less than 0.250 or more than 1.000, this test fails.

ANALYSIS PROCEDURE: See below; depends on the failure display, which is coded to indicate test voltage (high or low) and range of the failed test.

555 50000. (Confirming symptoms: If you press START repeatedly until the instrument completes its self check, the BIAS ON indicator will be lit even though the EXTERNAL BIAS switch is OFF, no bias is applied, and INT BIAS has not been selected.) The fault is probably in the 6-wire connection between keyboard and main board. Check to be sure that the cable connector properly engages all 6 pins at the keyboard.

5555 XXXX. Low voltage (75 mV rms), range 4. If XXXX is less than 0.250, check for a malfunction in the circuits that supply the test signal I<sub>h</sub> (U32, U31, U14, U13, U44 ...back to U4). Check the input signals and the gain through instrumentation amplifier U61.

However, if XXXX is greater than 1.000, check the test voltage and source resistance selector circuits (U32, controlled by U27 pins 6, 7); check filter selector U13, controlled by U27 pins 12, 13, as well as pins 14, 15, via U21 and U38. Also check for RAWSINE on D/A converter U44 pin 15.

5554 XXXX. High voltage (1.275 V), range 4. Check test voltage selector circuit and instrumentation amplifier.

555 3 XXXX. High voltage (1.275 V), range 3. Check signal at I<sub>h</sub> terminal with test fixture short circuited. Check signal at output of transconductance amplifier circuit (U58 pin 8) with test fixture short circuited.

555 2 XXXX. High voltage (1.275 V), range 2. (See previous suggestion.) 555 1

XXXX. High voltage (1.275 V), range 1. (See previous suggestion.)

444 E XXXX Test frequency and waveform check failure; the Digibridge will loop, automatically repeating the test and updating the display. The digit E indicates the frequency used in the test. (See below.) High voltage test signal is used, on range 4.

COMMENT: Measurement, summing of squares, and normalization are exactly as described for 555 D XXXX. Also the failure limits for XXXX are the same (0.250 and 1.000), except for tests 1 and 2, which have the limits: 0.125 and 1.000.

ANALYSIS PROCEDURE: check for the generation of the proper frequency (indicated in code by failure display, see below) by U5, U6, U7, U8, U20, U17, U18, U19, U22. Check filter circuitry in signal source (U13) and detector (U62, U40, U41). Operation can usually be enabled, in spite of failure messages "444 1 XXXX" or "444 2 XXXX", by pressing the START button.

444 6 XXXX. .0118 kHz.  
444 5 XXXX. .0968 kHz.  
444 4 XXXX. 0.480 kHz.  
444 3 XXXX. 1.200 kHz.  
444 2 XXXX. 6.000 kHz.  
444 1 XXXX. 6.0606 kHz.

33333 XXXX. PROM data checksum failure. If the checksum XXXX is not 0000, check all digital circuitry, starting with the 6502 microprocessor U30. Any error on the address or data bus could cause a checksum error ---check ROM U35, check RAM U36, U34; check all of the PIAs U3, U25, U26, U27. Look for address or data lines stuck at about 2 V or stuck low.

222 F XXXX. Calibration constants check failure; Digibridge hangs up, but will respond to keyboard inputs. The digit F is the range in question. COMMENT: Each check consists of a comparison between the stored calibration data for the range and the normal, expected values. The calibration can be expressed (essentially) as the conductance of the internal standard resistor. The Digibridge normalizes this conductance by dividing it by the nominal conductance of the standard, and displays the result, XXXX, which should be very close to 1.000. (See table giving source resistance for each range in paragraph 3.4.2.) If xx:xx is less than 0.2187 or more than 1.781, this test fails. ANALYSIS PROCEDURE: depends upon display; see below.

NOTE: This is a non-catastrophic failure. If you press the [Cs/D] key, the Digibridge will proceed with the self-check routine. The instrument can be operated as usual, but results may be erroneous. To restore accuracy, recalibrate, as described in paragraph 5.9.

222 4 XXXX. Range 4 may be incorrectly calibrated. Refer to paragraph 5.9 for recalibration procedure. If calibration is accomplished correctly, but this failure display appears when POWER is cycled OFF and ON, check battery Bl. (See Figure 6-4. Connect voltmeter only briefly.) If Bl voltage is less than 2.0 V, replace battery with a new one, as described in paragraph 5.7.3. If the problem is clearly associated with the loss of calibration when POWER is cycled OFF and ON, but the battery voltage is adequate, check the standby power circuit (Q9, Q10, CR9, CR15). Only if necessary, check Rs standard switching circuitry (R96 through R99, U36 pin 1, U27, U56, U57, U58).

222 3 XXXX. Range 3. Be sure that recalibration has been done correctly. If necessary, check Rs standard switching circuitry as described above.

222 2 XXXX. Range 2. Same comment as for range 3. 222 1

222 1 XXXX. Range 1. Same comment as for range 3.

222 0 XXXX. Frequency correction factor. ANALYSIS PROCEDURE: refer to 444 E XXXX.

11111 1111. Math chip operational check failure. COMMENT: This test is performed only if you have the high-speed interface option 1689-9620 installed.

NOTE: This is a non-catastrophic failure. If you press the [Cs/D] key, the Digibridge can be operated as usual, but measurement time will be typical of an instrument WITHOUT the high-speed option.

### 5.7.3 Battery and Fuse Replacement

#### BATTERY

If, at power-up, there is a failure display of 222 4 xxxx and investigation shows the most likely cause to be low battery voltage, you probably should replace battery Bl. (See power-up self check in paragraph 3.13 and above in 5.7; see part description in Table 1-3 and/or Section 6.) The procedure is as follows.

a. Remove the main board.

b. Find Bl at the right of center (see Figure 6-4). Cut its straps. Observe correct polarity, for replacement, + toward center of board.

## WARNING

Wear safety glasses while doing any work on the battery. DO NOT short or apply voltage to the battery. Dispose of the old one in accordance with local regulations for disposal of hazardous materials. DO NOT incinerate.

c. Unsolder and remove the old battery with care not to overheat.

d. Install the replacement and secure with straps (like the originals) or lacing cord, to safeguard terminals from strain.

e. Solder the terminals with care and DO NOT overheat.

f. Perform complete calibration procedure. Refer to paragraph 5.9.

## FUSE

If at power-up, there is a failure display of 555 5 XXXX (see Self-Check paragraph 3.13.1 and Trouble Analysis paragraph 5.7.1) replacement of the capacitor discharge fuse may be necessary (see Table 1-2).

a. Remove the top and bottom covers.

b. This fuse is located in a socket on the main board and behind the power switch. Unplug the fuse (using needle nose pliers) and replace.

## 5.7.4 Power Supply

### NOTE

In the following procedure, do the principal steps (a, b, c, d, ...) as long as everything checks out normally. But if a failure is found, follow the secondary steps, if any are given at the point of failure (1, 2, or 3).

Check the power supply (V assembly) if there is a massive failure (nothing works) or as a starting procedure in any thorough analysis. Refer to Figure 5-3.

### NOTE

If a voltage regulator (U1, U2, or U3) must be replaced, be sure to spread silicone grease (like Dow Corning compound no. 5) on the surface toward the heat sink. For U1, coat both sides of the insulating washer.

a. Check the output voltages, using a digital voltmeter, with ground reference at V-J1, pin 9 (ribbon cable unplugged), as follows:

Pin 1 = +4.75 V to +5.25 V,  
Pin 3 = +4.75 V to +5.25 V,  
Pin 4 = -7.6 V to -8.4 V.

1. If trouble is found at step a, check both analog and digital "+ 5 V" circuit: At outputs of U1 and U2: + 5 Vdc (regulated).  
At WTI (inputs of U1 and U2): + 10.8 Vdc, when primary voltage is 115 Vrms, between terminals 1 and 2 of transformer T1.  
Across input to diode bridge (yellow-to-yellow): 10 Vrms.
2. Check ".8 V" circuit: At output of U3: -8 Vdc (regulated). At input (center terminal) of U3: -13.8 Vdc, when primary voltage is 115 Vrms, between terminals 1 and 2 of transformer T1.  
Across WT7 to WT8: 11.3 Vrms.
3. Check power-line circuit to primary of transformer V-T1.

b. Make a check similar to step a, with ribbon cable connected, ground reference at front edge of MB board (near the test fixture), probing MB-J5 from below the board, referring to Figure 6-4. (This checks for overload outside the power supply.)

### 5.7.5 Sinewave Generator Checks

Check the MB-board circuits that supply the test signals to the DUT, as follows.

a. Perform the zeroing procedure (both open circuit and short circuit), as described in paragraph 5.9.2 of the recalibration procedure.

b. Make the following test setup and keyboard selections.

```
[FUNCTION] --MEASURE  
[DISPLAY] --VALUE  
[MEASURE RATE] ---SLOW  
[MEASURE MODE] --CONT.  
[EQUIVALENT CIRCUIT] --SERIES
```

c. Install a 10 kilohm resistor as the DUT.

d. Use an oscilloscope to verify that the signal at the right-hand end of the DUT in the test fixture is a sine wave, as follows. (For scope ground return, connect to the ground plane on the circuit board or via a 6-32 screw to the tapped hole in the left-hand end of the test fixture.)

Frequency: 1 kHz,  
Amplitude: approx 1.5 Vpk-pk.

e. If no fault appears in steps a through d, skip to paragraph 5.7.6.

## NOTE

The prefix "MB-" for main board is omitted in the following text, wherever it is not necessary for clarity.

f. With an oscilloscope, observe and measure the signal at U32 pin 15. It must be a 1-kHz sinewave, 3.0 V<sub>pk-pk</sub>.

g. With an oscilloscope, check at U31 pin 8, UI4 pin 14, and UI4 pin 8, for a 1-kHz sinewave, 3.0 V<sub>pk-pk</sub>. If the test signal is missing, check backward, to the precision oscillator U4, then forward through dividers and sinewave generator, as shown on the main-board schematic sheets 2 and 3, in Section 6 of this manual.

### 5.1.6 Front End Amplifiers and Switches

Check the MB-board analog circuits that process the measurement signals from the test fixture to the point of A/D conversion, as follows.

a. Verify that there is a normal test signal at the test fixture. (See paragraph 5.7.5 step d, above.)

b. Check the range switching circuitry as follows. (Be sure that the RANGE HELD indicator is NOT lit.) Insert as DUT each of following resistors. With a scope connected to the right side of each DUT in turn, check for a 1-kHz sinewave with the level indicated below.

- 10 ohm --test signal should be 1.0 V<sub>pk-pk</sub> (range 4)
- 1 kohm --test signal should be 2.4 V<sub>pk-pk</sub> (range 3)
- 10 kohm --test signal should be 2.0 V<sub>pk-pk</sub> (range 2)
- 1 Mohm --test signal should be 3.1 V<sub>pk-pk</sub> (range 1)

If discrepancy is found in step b, check for 3.4 V<sub>pk-pk</sub> at the appropriate signal source check point --as described in Table 5-4 --for the particular range in use.

c. Install a 1-kilohm resistor in the test fixture. Check the PH circuit at U59 pin 8, for a 1-kHz sinewave, 2.4 V<sub>pk-pk</sub>.

If there is discrepancy in step c, but U59 pin 10 has a 2.4 V<sub>pk-pk</sub> sinewave, then U59 is faulty.

d. Check the output of the IL circuit at U59 pin 14 for a 1-kHz sinewave, with the following selection of DUTs in turn:

- 10 ohm ---signal level should be 3.2 V<sub>pk-pk</sub> (range 4)
- 1 kohm ---signal level should be 970 mV<sub>pk-pk</sub> (range 3)
- 10 kohm ---signal level should be 1.3 V<sub>pk-pk</sub> (range 2)
- 1 Mohm ---signal level should be 315 mV<sub>pk-pk</sub> (range 1)

If a discrepancy is found in step d, check similarly at the R-Std signal check point --as described in Table 55. The signal should be the same as listed in step d above for U59 pin 14, for the particular DUT and range.



Table 5-4  
SOURCE RESISTOR RANGE SWITCHING CHECKS

RNG1	Control Signals		Range	Nom Source Resistance	Signal Source Check Point
	RNG0	LSRC			
0	0	0	4	25 ohm	U32 pin 12
0	1	1	3	400 ohm	U32 pin 14
1	0	1	2	6.4 kohm	U32 pin 15
1	1	1	1	97.4 kohm	U32 pin 11

Table 5-5  
DETECTOR (STANDARD) RESISTOR RANGE SWITCHING CHECKS

RNG1	Control Signals		Range	Nominal Standard Resistance	R-Std Signal Check Point
	RNG0	LSTD			
0	0	0	4	25 ohm	U56 pin 12
0	1	1	3	400 ohm	U56 pin 14
1	0	1	2	5.97 kohm	U56 pin 15
1	1	1	1	97.4 kohm	U56 pin 11

Table 5-6  
EQUIPMENT FOR ACCURACY VERIFICATION

Name	Requirements	Recommended
Capacitor	Decade, 3-terminal, 1 pF to 1 uF, accuracy: +/- 0.05% +/- 0.5 pF	GenRad 1413-9700
Capacitor	Decade, 50 pF to 1.11115 uF, accuracy: +/- 0.5%	GenRad 1412
Extender cable	Adapt test fixture to type 874 connectors	GenRad 1688-9600
Adaptors (2 req'd)	Tee with type 874 connectors	Gilbert 0874-9910*
Extender cable	Adapt test fixture to binding posts and banana plugs	GenRad 1657-9600
Capacitor	Four-terminal, ratio type, 10 uF to 100 uF, accuracy: +/- 0.25%	GenRad 1417-9700
Capacitor	DC blocking, 500 uF, 10 V	GE 69F2214G2
Capacitor	Three-terminal, 1 uF, acc: +/- 0.02%, certified within +/- 0.03% including effects of aging since last certification	GenRad 1409-Y
Resistor	Decade, 3-terminal, 1 ohm to 1 Mohm, accuracy: +/- 0.01%	GenRad 1433-H
Inductors	Fixed, 2-terminal, 1 mH, +/- 0.1%	GenRad 1482-E
	100 mH, +/- 0.1%	GenRad 1482-L
	1 H, +/- 0.1%	GenRad 1482-P
	10 H, +/- 0.1%	GenRad 1482-T

\*Gilbert Engineering Co., Inc., 5310 W. Camelback Rd, Glendale, AZ 85301

## 5.8 ACCURACY VERIFICATION

### 5.8.1 General

This procedure is a more rigorous alternative to the performance verification described in paragraph 5.4. Precision standards of impedance are required for this procedure, which checks the accuracy as well as the overall performance of the instrument. It will be controlled from the front panel, without disassembly. Table 5-6 lists the recommended standards and associated equipment. For the C accuracy checks, the standard is a precision decade capacitor.

Calibration of Standard. The acceptable RLC readout (min to max range) may have to be modified if the actual (calibrated) value of your standard or its accuracy (either or both) is different from the tabulated value(s).

For example, if your 10-pF standard is known to be  $10.18 \pm 0.25$  pF, then compute the new tolerance as follows: Digibridge accuracy  $\pm 0.02$  percent. The limits are, therefore, 9.92 to 10.44 pF.

Verify that the instrument meets performance specifications as follows.

### 5.8.2 Capacitance Measurement Accuracy (Small and Medium C, Ranges 1, 2, 3)

Make the test setup and verify instrument performance as follows:

#### CAUTION

Be sure the line voltage switch, rear panel, is correctly set for your power line voltage.

a. After the line voltage switch has been set to correspond to the input line voltage, connect the power cord and switch POWER ON.

b. Connect the 1688-9600 extender cable (type 874 connectors) to the Digibridge test fixture, as described in paragraph 3.2.5. The screws must be hand tightened because they provide the ground (guard) connection.

c. Connect the "high" leads (red and red white) to one of the 874 Tee connectors. Connect the "low" leads (black and black/white) to the other 874 tee.

d. Before measurement, zero the Digibridge as follows. In this process, the Digibridge automatically measures stray parameters and retains the data, which it uses to correct measurements so that results represent parameters of the DUT alone, without (for example) test-fixture or adaptor capacitance.

Be sure that MEASURE RATE is SLOW and that the RANGE HELD indicator is NOT lit. DO NOT have test voltage programmed to other than 1 V, nor frequency to other than 1 kHz.

*Open Circuit.*

**Leave** the two type 874 tees connected to the 1688-9600 extender cable, but not connected to each other.

**Press** [FUNCTION] key (if necessary) to select MEASURE function.

**Press** [MEASURE MODE] key (if necessary) to select TRIGGERED mode.

**Press** these keys deliberately: [1] [6] [8] [9][=] [SHIFT] [OPEN].

**Confirm** that the GO indicator is lit. Press the START button.

**Keep** hands and objects at least 10 cm (4 in.) from test fixture.

**Wait** for the GO indicator to be lit again, on the keyboard (not on any remote test fixture).

(The RLC display should be .00000).

*Short Circuit.*

**Connect** the two type 874 tees together.

**Press** these keys deliberately: [1] [6] [8] [9][=] [SHIFT] [SHORT].

**Confirm** that the GO indicator is lit. Press the START button.

**Wait** for the GO indicator to be lit again, on the keyboard (not on any remote test fixture).

**Disconnect** the two type 874 tees from each other.

e. Connect the type 874 tee with the red cables to the HIGH terminal of the 1413-9700 decade capacitor. Connect the other tee (black cables) to the LOW terminal of this capacitor.

f. Set the decade capacitor dials to 00000 pF.

**Press** the Cs/D key.

**Press** these keys deliberately: [1] [6] [8] [9][=] [SHIFT] [OPEN].

**Confirm** that the GO indicator is lit. Press the START button.

**Wait** for the GO light. The RLC display should be .00000 pF.

**Press** [MEASURE MODE] key to select CONT.

**Press** [EQUIVALENT CIRCUIT] key to select SERIES.

g. Set the decade capacitor to 10 pF. If necessary, press the START button. Verify that the C and D measurements subsequently displayed on the Digibridge are within the limits given in the first *line* of Table 5-7.

h. Similarly, for each line in the table, set the capacitor and the Digibridge measurement rate, and verify that the resulting measurements are satisfactory.

i. Disconnect the 1688-9600 extender cable from the capacitor and the Digibridge.

NOTE

Whenever doing short-circuit or open-circuit zeroing, remember that the GO light to watch is the one on the keyboard (not on any remote test fixture, for example).

Table 5-7  
CAPACITANCE ACCURACY CHECKS (RANGES 1 TO 3)

Capacitor Setting	Meas Rate	Digibridge Accuracy	Decade C Accuracy	RLC Display Min*	RLC Display Max*	QDR Display Max**
----- Range 1 -----						
10 pF	SLOW	.02%	5.05%	9.493	10.507	6100 ppm
100 pF	SLOW	.02%	.55%	99.430	100.57	2500 ppm
1500 pF	SLOW	.02%	.083%	1498.4	1501.6	700 ppm
1500 pF	MED	.05%	.083%	1498.0	1502.0	1002 ppm
1500 pF	FAST	.15%	.083%	1496.5	1503.5	1705 ppm
6400 pF	SLOW	.02%	.058%	6395.0	6405.0	500 ppm
----- Range 2 -----						
10 nF	SLOW	.02%	.055%	9.9925	10.008	200 ppm
25 nF	SLOW	.02%	.052%	24.982	25.018	200 ppm
25 nF	MED	.05%	.052%	24.974	25.026	500 ppm
25 nF	FAST	.15%	.052%	24.949	25.051	1200 ppm
100 nF	SLOW	.02%	.051%	99.929	100.07	200 ppm
----- Range 3 -----						
200 nF	SLOW	.02%	.05%	199.86	200.14	200 ppm
400 nF	SLOW	.02%	.05%	399.72	400.28	200 ppm
400 nF	MED	.05%	.05%	399.60	400.40	500 ppm
400 nF	FAST	.15%	.05%	399.20	400.80	1200 ppm
1000 nF	SLOW	.02%	.05%	999.30	1000.7	200 ppm

\* These ranges of acceptable displays are based on specified accuracy of decade capacitor, recently calibrated. If the capacitor values are known to higher accuracy by special calibration or lesser accuracy because of long-term drift, the acceptable RLC max and min criteria must be revised accordingly.

\*\*Based on D values stated in GenRad documentation for the type 1413 decade capacitor. If capacitor D values are known more accurately, the acceptable QDR display criteria can be reduced accordingly.

Table 5-8  
CAPACITANCE ACCURACY CHECKS (RANGE 4)

Capacitor Setting	Digibridge Accuracy	St'd C Accuracy	RLC Display (Uncorrected)		RLC Display Correction (See text)	Acceptable D	
			Min	Max		Min	Max
1 uF	--	--	{Used to determine K}			.0085	.0115
10 uF	.02%	.07%	9.991	10.009	+10K	.0085	.0115
100 uF	.02%	.07%	99.91	100.09	+100K	.0085	.0115

### 5.8.3. Capacitance Measurement Accuracy (Large C, Range 4)

This procedure follows after paragraph 5.8.2. (Leave the test frequency at 1 kHz, the test voltage at 1 V, the measure rate SLOW, the selected parameter Cs/D, and the RANGE HELD indicator NOT lit.)

a. Connect the 1657-9600 extender cable (with banana plugs) to the Digibridge test fixture. Hand tighten the screws, to provide the ground (guard) connection.

b. Connect the "high" leads (red and red/white) together. Separately connect the "low" leads (black and black white) together.

c. Before measurement, zero the Digibridge as follows:

*Open Circuit.*

**Leave** the high (red) banana plug stack disconnected from the low (black) stack.

**Press** [FUNCTION] key (if necessary) to select MEASURE.

**Press** [MEASURE MODE] key (if necessary) to select TRIGGERED mode.

**Press** these keys deliberately: [1] [6][8] [9][=] [SHIFT] [OPEN].

**Confirm** that the GO indicator is lit.

**Keep** hands and objects at least 10 cm (4 in.) from test fixture.

**Press** the START button.

**Wait** for the GO indicator to be lit. The RLC display should be .00000 pF.

*Short Circuit.*

**Connect** the two banana plug stacks together; leave the guard (black/green) open.

**Press** these keys deliberately: [1][6][8][9][=][SHIFT] [SHORT].

**Confirm** that the GO indicator is lit.

**Press** the START button.

**Wait** for the GO indicator to be lit. The RLC display should be .00000 ohms.

**Press** the [MEASURE MODE] key to select CONT.

d. Connect the three-terminal-uF capacitance standard (GR 1409- Y) as follows. This standard should be certified to an accuracy of +/- .03% including the effects of aging.

RED,	IH: capacitor H binding post
RED & WHITE,	PH: stacked on the red banana plug
BLACK	IL: capacitor L binding post
BLACK & WHITE,	PL: stacked on the black banana plug
BLACK & GREEN	G: capacitor G, NOT linked to L

e. Verify that the RLC display agrees with the certified value of the standard (corrected for temperature if appropriate) within  $\pm 0.0005$   $\mu\text{F}$  which is the sum of .03% for the standard and 0.02% for the Digibridge.

f. Calculate the difference D1, as follows, and retain it for future use.

$$D1 = (\text{displayed measurement}) - (\text{value of standard}) \mu\text{F}$$

g. Remove the 1- $\mu\text{F}$  standard and connect the 4-terminal ratio-type capacitance standard (GR 1417) and the blocking capacitor (500  $\mu\text{F}$ ) as follows. Be sure that the dc blocking capacitor is fully discharged before connecting it. Notice that only the left-hand terminals of the standard are used.

RED,	IH: + end of blocking capacitor
-end of blocking cap:	CURRENT H terminal of capacitance standard
RED & WHITE	PH: POTENTIAL H terminal of capacitance standard
BLACK	IL: CURRENT L terminal of capacitance standard
BLACK & WHITE	PL: POTENTIAL L terminal of capacitance standard
BLACK & GREEN	G: uninsulated terminal of capacitance standard

h. Set the dials on the capacitance standard thus:

CAPACITANCE: 1  $\mu\text{F}$  TEST  
FREQUENCY: 1 kHz

#### NOTE

For detailed information on the GR 1417 4-Terminal Capacitance Standard, refer to its instruction manual.

i. Read the RLC display, which should be close to the nominal value of the standard: 1  $\mu\text{F}$ .

j. Calculate the difference D2, as follows, and retain it for future use.

$$D2 = (1.0000 \mu\text{F}) - (\text{displayed measurement}) \mu\text{F}$$

NOTE: The DQ display should show  $D = .0085$  to  $.0115$ .

k. Calculate the calibration factor K as follows:

$$K = D1 + D2 \quad (\mu\text{F})$$

Example. Suppose that in step e, the display is 1.0013, and the value of the standard is 1.0006; then  $D1 = +.0007$   $\mu\text{F}$ . In step i, the nominal is 1.0000; suppose that the display is 1.0024; then  $D2 = -.0024$   $\mu\text{F}$ . The correction K would therefore be:

$$+.0007 - .0024 = -.0017 \text{ (}\mu\text{F)}.$$

l. Reset the capacitance-standard dial to: CAPACITANCE = 10  $\mu\text{F}$ .

m. Read the RLC display and correct it by adding 10K. (For example, if the display is 10.023  $\mu\text{F}$  and if  $K = -.0017$ , the corrected measurement is 10.006  $\mu\text{F}$ .) Verify that the corrected measurement is within the acceptable extremes for the 10- $\mu\text{F}$  setting in Table 5-8.

n. Reset the capacitance-standard dial to: CAPACITANCE = 100  $\mu\text{F}$ . Read the RLC display and correct it by adding 100K. As in step m, verify that the corrected measurement is within the acceptable extremes shown in Table 5-8.

Table 5-9  
RESISTANCE ACCURACY CHECKS (at 1 kHz)

Standard Resistor Setting	Equivalent Circuit	Measure Rate	Typical Standard Accuracy*	Digibridge Accuracy	RLC Display Acceptable Extremes*
10.00 ohms	Series	SLOW	.03%	.02%	9.995 to 10.005
25.00 ohms	Series	SLOW	.018%	.02%	24.990 to 25.010
25.00 ohms	Series	MED	.018%	.05%	24.893 to 25.017
25.00 ohms	Series	FAST	.018%	.12%	24.965 to 25.035
90.00 ohms	Series	SLOW	.012%	.02%	89.971 to 90.029
200.0 ohms	Series	SLOW	.011%	.02%	199.94 to 200.06
400.0 ohms	Series	SLOW	.01%	.02%	399.88 to 400.12
400.0 ohms	Series	MED	.01%	.05%	399.76 to 400.24
400.0 ohms	Series	FAST	.01%	.12%	399.48 to 400.52
1500 ohms	Parallel	SLOW	.01%	.02%	1499.5 to 1500.5
2000 ohms	Parallel	SLOW	.01%	.02%	1999.4 to 2000.6
6400 ohms	Parallel	SLOW	.01%	.02%	6398.1 to 6401.9
6400 ohms	Parallel	MED	.01%	.05%	6396.2 to 6403.8
6400 ohms	Parallel	FAST	.01%	.12%	6391.6 to 6408.4
24 kilohms	Parallel	SLOW	.01%	.02%	23.993 to 24.007
30 kilohms	Parallel	SLOW	.01%	.02%	29.991 to 30.009
100 kilohms	Parallel	SLOW	.01%	.02%	99.97 to 100.03
100 kilohms	Parallel	MED	.01%	.05%	99.94 to 100.06
100 kilohms	Parallel	FAST	.01%	.12%	99.87 to 100.13

-----  
\* If the calibrated value of the resistance standard is slightly different from the nominal value, or if the standard's accuracy is different from the typical accuracy, correct the "acceptable extremes" accordingly.

#### 5.8.4 Resistance Measurement Accuracy

This procedure follows after paragraph 5.8.3. (Thus, test frequency = 1 kHz, test voltage = 1 V, measure rate = SLOW, range held indicator is NOT lit, and parameter Cs/D is specified.)

a. With the Digibridge still connected to the 1657-9600 extender cable, connect its banana plugs to the 1433-H Decade Resistor as follows:



"high" leads (red and red/white) to the H binding post .  
"low" leads (black and black/white) to the L binding post  
guard lead (black/green) to the G binding post  
Disconnect any link between the G and L binding posts.

b. Set the decade resistor dials to 00000 ohms.

**Press** the [Rs/Q] key.

**Press** [:MEASURE MODE] key to select TRIGGERED.

**Press** these keys deliberately: [1] [6][8] [9] [=] [SHIFT] [SHORT].

**Confirm** that the GO indicator is lit. Press the START button.

**Wait** for the GO indicator to be lit again. The RLC display should be .00000 ohms.

**Press** [MEASURE MODE] key to select CONT.

c. Refer to Table 5-9. Set the decade resistor dials to 0000010, as indicated in the first line of the table and verify that the RLC display is between the extremes listed. Repeat for each line of the table, setting the decade resistor dials, Digibridge equivalent circuit, and measurement rate, and verifying the results, as tabulated.

### 5.8.5 Inductance Measurement Accuracy

This procedure follows after paragraph 5.8.4. (Thus, test frequency = 1 kHz, test voltage = 1 V, measure rate = SLOW, range held indicator is NOT lit, and parameter Rs/Q is specified.)

a. Connect the 1657-9600 extender cable to the Digibridge test fixture. Hand tighten the screws, to provide ground (guard) connection.

b. Connect the "high" leads (red and red/white) together and separately connect the "low" leads (black and black/white) together.

c. Before measurement, zero the Digibridge as follows:

*Open Circuit.*

**Keep** the "high" banana-plug stack separated from the "low" stack.

**Press** [FUNCTION] key (if necessary) to select MEASURE function.

**Press** [MEASURE MODE] key (if necessary) to select TRIGGERED mode.

**Press** these keys deliberately: [1][6][8][9][=][SHIFT][OPEN].

**Confirm** that the GO indicator is lit.

**Keep** hands and objects at least 10 cm (4 in.) from test fixture.

**Press** the START button.

**Wait** for the GO indicator to be lit again. The RLC display should be .00000 pF.

*Short Circuit.*

**Connect** the 2 banana-plug stacks together, leave the guard (black/green) open.

**Press** these keys deliberately: [1][6][8][9][ #SHIFT] [SHORT].

**Confirm** that the GO indicator is lit.

**Press** the START button.

**Wait** for the GO indicator to be lit again. The RLC display should be .00000 ohms.

**Press** the [MEASURE MODE] key to select CONT.

Table 5-10  
INDUCTANCE ACCURACY CHECKS (at 1 kHz)

Standard Inductor (LS)	Range	Measure Rate	Digibridge Accuracy	Typical Standard Accuracy	RLC Display* Acceptable Extremes	Expected Q**
1 mH	4	SLOW	.02%	0.1%	.9988 to 1.0012	7.5
		MED	.05%	0.1%	.9985 to 1.0015	---
		FAST	.15%	0.1%	.9975 to 1.0025	---
100 mH	3	SLOW	.02%	0.1%	99.88 to 100.12	7.5
		MED	.05%	0.1%	99.85 to 100.15	---
		FAST	.15%	0.1%	99.75 to 100.25	---
1 H	2	SLOW	.02%	0.1%	.9988 to 1.0012	10
		MED	.05%	0.1%	.9985 to 1.0015	---
		FAST	.15%	0.1%	.9975 to 1.0025	---
10 H	1	SLOW	.02%	0.1%	9.988 to 10.012	10
		MED	.05%	0.1%	9.985 to 10.015	---
		FAST	.15%	0.1%	9.975 to 10.025	---

\* These ranges of acceptable displays are based on specific accuracy of decade inductors, recently calibrated. If the inductance values are known to higher accuracy by special calibration or lesser because of long-term drift, the "acceptable RLC extremes" must be revised accordingly.

\*\* Based on Q of Type 1482 Standard Inductor, as stated in GenRad documentation. If inductor Q values are known more accurately, the Q can be checked to tighter tolerances.

d. Connect the banana plugs of the 1687-9600 extender cable to the I-mH inductance standard (1482-E) as follows:

Connect link between ground and LOW binding posts.  
 "high" leads (red and red/white) to the LOW binding post and case.  
 "low" leads (black and black/white) to the HIGH binding post.  
 guard lead (black/green) hanging free.

NOTE: These standard inductors are calibrated using a two-terminal connection with the case tied to the LOW terminal.

e. Press the [Ls/Q] key to select inductance parameter.  
 Press the [EQUIVALENT CIRCUIT] key (if necessary) to select SERIES.

f. Refer to Table 5-10 and verify that the RLC display is between the extremes listed for 1 mH, SLOW measurement rate (first line of table).

g. Similarly, with the inductance standards 1 mH, 100 mH, and 1 H, as indicated in the LS column, and with the indicated measurement rate, verify that the RLC display is acceptable for each line of the table, for ranges 4,3,2, and 1.

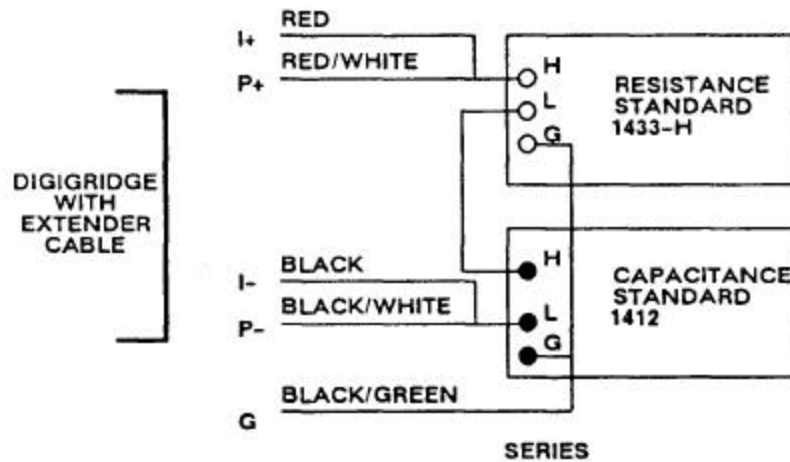

60042.0

Figure 5-16. Series connections of standards for D accuracy checks.

### 5.8.6 D Measurement Accuracy

Figure 5-16.

Verify D-measurement accuracy with the following procedure. Dissipation-factor checks will be made using series equivalent circuit, with corresponding connections of resistance and capacitance standards.

This procedure follows after paragraph 5.8.5. (Thus, test frequency = 1 kHz, test voltage = 1 V, measure rate = SLOW, range held indicator is NOT lit, and parameter L/Q is specified.)

- a. Connect the 1657-9600 extender cable to the Digibridge remote test fixture. Hand tighten the screws, to provide ground (guard) connection.
- b. Connect the "high" leads (red and red/white) together and separately connect the "low" leads (black and black/white) together.
- c. Press [FUNCTION] key to select ENTER function. To select 100 Hz, press [.] [1] [=] [SHIFT] [FREQUENCY].
- d. Before measurement, zero the Digibridge as follows:

*Open Circuit.*

**Keep** the "high" banana-plug stack separated from the "low" stack.  
**Press** [FUNCTION] key (if necessary) to select MEASURE function.  
**Press** [MEASURE MODE] key (if necessary) to select TRIGGERED mode.  
**Press** these keys deliberately [1] [ ] [8] [9] [=] [SHIFT] [OPEN].  
**Confirm** that the GO indicator is lit.  
**Keep** hands and objects at least 10 cm (4 in.) from test fixture.  
**Press** the START button.

**Wait** for the GO indicator to be lit again. The RLC display should be 00000 pF.

*Short Circuit.*

**Connect** the 2 banana-plug stacks together, leave the guard (black/green) open.

**Press** the keys deliberately: [I] [6j[8] [9][=] [SHIFT][SHORT]

**Confirm** that the GO indicator is lit.

**Press** the START button.

**Wait** for the GO indicator to be lit again. The RLC display should be 00000 ohms.

**Press** the [MEASURE MODE] key to select CONT.

e. Using the extender cable and plain bus wire, connect the decade R and C standards in series, as DUT to the Digibridge, as shown in Figure 5-16 and tabulated below.

RED, I+:	stack on P+
RED & WHITE, P+:	resistor H
BLACK, I-:	stack on P
BLACK & WHITE, P-:	capacitor L
BLACK & GREEN, G:	resistor G, capacitor H side post, and capacitor L side post (suitably connected together with a link and/or bus wire).

Also connect with a short jumper from resistor L to capacitor H.

f. Confirm or select measurement conditions on the Digibridge thus:

DISPLAY	-VALUE
MEASURE RATE	-SLOW
EQUIVALENT CIRCUIT	-SERIES
FREQUENCY	-100 Hz
MEASURE MODE	-CONT
HOLD RANGE	-autorange
Parameter	-C/D
EXT BIAS	-OFF

g. Set the resistance and capacitance standards to the values given in line 1 of Table 5-11. Verify that the DQ display is within the range given, inclusive. Lock in this range on the 1689 by pressing [SHIFT][HOLD RNG].

**Table 5-11**  
**D-ACCURACY CHECK**

Resistance Standard	Capacitance Standard	DQ Display (Min to Max)
50 $\Omega$	0.1592 $\mu\text{F}^*$	.0046 to .0054
100 $\Omega$	same*	.0096 to .0104
500 $\Omega$	same*	.0496 to .0504
1 $\text{k}\Omega$	same*	.0996 to .1004
5 $\text{k}\Omega$	same*	.4995 to .5005
10 $\text{k}\Omega$	same*	.9994 to 1.001
50 $\text{k}\Omega$	same*	4.992 to 5.008
90 $\text{k}\Omega$	same*	8.975 to 9.025

\* Set the capacitance standard to obtain, on the RLC readout, the tabulated capacitance.

h. Continue down the table, verifying each line. Because the capacitance in the series equivalent circuit is different from the decade capacitor setting when the series resistance is large, use the RLC readout to indicate capacitance in those lines of the table.

### 5.8.7 Limit Comparison Bins

Verify the Digibridge performance with regard to limit comparison and bin assignments as follows. The resistance standard 1433-H (Figure 5-16) or equivalent is required for this test.

a. Confirm or select measurement conditions on the Digibridge as listed:

FUNCTION	-ENTER
DISPLAY	-VALUE
MEASURE RATE	-SLOW
EQUIVALENT CIRCUIT	-SERIES
FREQUENCY	-1 kHz (Press [1][=][SHIFT][FREQUENCY]) if necessary
MEASURE MODE	-CONT
RANGE	-Select range 3 by repeatedly pressing R/Q for the first kohm range and then press [SHIFT] [HOLD RNG], if necessary to hold.
EXT BIAS	-OFF

b. Connect the 1657-9600 extender cable from the Digibridge remote test fixture as follows:

- "high" leads (red and red/white) to resistor H
- "low" leads (black and black/white) to resistor L
- "ground" lead (black/green) to resistor G

c. Refer to Table 5-12. After making the sequence of key-strokes (using the appropriate limit entry keys) shown under "Entry", verify that the Digibridge numerical displays are like the numbers tabulated in the same row of the table under "Displays". Make all entries as tabulated,

d. Select on the Digibridge:

FUNCTION - MEASURE  
 DISPLAY - BIN No.

e. Refer to Table 5-13. For each setting of the resistance standard, verify that the DQR display is blank, the bin (RLC) display is a single digit as tabulated, and the GO/NO-GO lights work as tabulated.

Table 5-12  
 ENTRY OF LIMITS

Entry		RLC Display	DQ Display
(none)		(blank)	(blank)
[5]	[=] [SHIFT] [NOM VALUE]	5.0000	(blank)
[.]	[1] [=] [SHIFT] [BIN No.] [0] [0]	(blank)	.1000
[1]	[%] [=] [SHIFT] [BIN No.] [0] [1]	5.0500	4.950
[2]	[%] [=] [SHIFT] [BIN No.] [0] [2]	5.1000	4.900
[3]	[%] [=] [SHIFT] [BIN No.] [0] [3]	5.1500	4.850
[4]	[%] [=] [SHIFT] [BIN No.] [0] [4]	5.2000	4.800
[5]	[%] [=] [SHIFT] [BIN No.] [0] [5]	5.2500	4.750
[6]	[%] [=] [SHIFT] [BIN No.] [0] [6]	5.3000	4.700
[7]	[%] [=] [SHIFT] [BIN No.] [0] [7]	5.3500	4.650
[8]	[%] [=] [SHIFT] [BIN No.] [0] [8]	5.4000	4.600
[9]	[%] [=] [SHIFT] [BIN No.] [0] [9]	5.4500	4.550
[10]	[%] [=] [SHIFT] [BIN No.] [0] [10]	5.5000	4.500
[11]	[%] [=] [SHIFT] [BIN No.] [0] [11]	5.5500	4.450
[12]	[%] [=] [SHIFT] [BIN No.] [0] [12]	5.6000	4.400
[13]	[%] [=] [SHIFT] [BIN No.] [0] [13]	5.6500	4.350

Table 5-13  
BIN ASSIGNMENT CHECK

Resistance Standard Set To	GO/NO-GO	Bin Display
5000 $\Omega$	GO	1
5057 $\Omega$	GO	2
5107 $\Omega$	GO	3
5157 $\Omega$	GO	4
5207 $\Omega$	GO	5
5257 $\Omega$	GO	6
5307 $\Omega$	GO	7
5357 $\Omega$	GO	8
5407 $\Omega$	GO	9
5457 $\Omega$	GO	10
5507 $\Omega$	GO	11
5557 $\Omega$	GO	12
5607 $\Omega$	GO	13
5657 $\Omega$	NO-GO	14
0000 $\Omega$	NO-GO	0
5000 $\Omega$	GO	1

NOTE 1 - When using the 1689-9605 remote test fixture, use the START bar and observe the GO/NO-GO indicators on this fixture, rather than those on the Digibridge.

NOTE 2 - When the handler interface option is present, the bin signal lines can be checked with a scope (during the above procedure) to verify their logic "low" state. Refer to the interface option schematic in Section 6.

## 5.9 RECALIBRATION

### 5.9.1 Preparation

*Introduction.* This service procedure requires a set of external calibration resistors whose R and Q values are exactly known and can require a frequency counter. (See table in next paragraph.) For the frequency correction, the counter makes a measurement; but for the four internal resistance standards, the Digibridge makes the measurements. After recalibration, the Digibridge retains in RAM the corrections that the microprocessor needs to compensate for the small errors in the actual values of test frequency and internal standard resistor parameters. (Therefore, the Digibridge calculates its measurement results correctly, accomplishing by calculation the same result that would be obtained if the recalibration process actually trimmed the internal standards exactly to their nominal values.)

*Required Equipment.* Refer to Table 5-14.

Table 5-14  
EQUIPMENT FOR RECALIBRATION

GenRad No.	Description	Requirements
---	Temperature stabilized room	23 degrees C (73.4 F) recommended
1689-9604	Kit of 4 calibration resistors with nominal resistances of 24.9, 374 ohms; 5.97, 95.3 kilohms, and calibration "open" and "short".	R and Q values known at 1 kHz, R accuracy +/- .002%, calibration traceable to NBS; Q calibrated to +/- 25 ppm.*
---	Universal counter/timer, with ground strap **	Accuracy better than +/-10 ppm (+/-2 ppm preferred) in averaging multiple period measurement.
---	Screw, bright plated brass **	Size: 0.138-32 x 0.5 (diam-thds/in. x length, in.)

\* Refer to calibration certificate (Form No. 1689-8204) supplied with the kit.

\*\* Counter and screw are needed for frequency calibration only.

*Decision Whether Frequency Calibration is Needed.* The frequency calibration (paragraph 5.9.7) is necessary -and should be completed before recalibrating any range -if any of the following is true:

1. If the battery B1 has been replaced or disconnected for any reason.
2. If either RAM (U36) or ROM (U35) has been replaced or disconnected.
3. If the RAM standby battery circuit has been serviced.
4. If oscillator U4 has been replaced.

*Procedure*

- a. Remove any adaptor that may be in the test fixture. Inspect the Digibridge test fixture for cleanliness. If it is dirty or if it is scheduled for periodic cleaning soon, clean the test fixture as described in paragraph 5.6.
- b. Place all equipment including the Digibridge(s) to be recalibrated in the temperature stabilized room, normally at 23 degrees C.
- c. Switch Digibridge(s) ON and if frequency calibration is needed (see above) switch the counter power ON. Allow all equipment to stabilize for at least two hours. Leave the Digibridge test conditions at the defaults.
- d. If frequency calibration is needed (see "Decision ..." above), skip to the procedure of paragraph 5.9.7 before zeroing and recalibrating ranges 4, 3, 2, and 1.

*Decision Whether K Factor Calibration Is Needed.* The K Factor Calibration (paragraph 5.9.8) is necessary and should be completed before recalibrating any range, if the following is true.

1. If battery, RAM or ROM have been replaced or disconnected for any reason.
2. If the RAM standby battery circuit has been serviced.



### 5.9.2 Zeroing and Selecting "DQ in PPM"

This zeroing procedure is like the routine procedure in Operation, Section 3. In this process, the Digibridge automatically measures stray parameters related to the test fixture and associated circuits and retains the data, which it uses in each recalibration step below to correct measurements so that results most accurately represent parameters of the external calibration resistor alone. *NOTE: Leave the I- T factor at 1 (the power-up default) or more, NOT less. (See para 3.5.5.)*

#### *Open Circuit.*

- a. Press [FUNCTION] key (if necessary) to select MEASURE mode.  
Press [MEASURE MODE] key (if necessary) to select TRIGGERED mode.
- b. Be sure that the test fixture is open circuited.
- c. Press these keys: [1] [6] [8] [9] [=] [SHIFT] [OPEN]. (A zero in each, left and right displays, and the GO indicator should be lit, confirming this step.)
- d. Keep hands and objects at least 10 cm (4 in.) from test fixture.
- e. Press the START button. The GO indication disappears.
- f. Wait for the GO indicator to be lit again (approximately 10 seconds).

#### *Short Circuit.*

- a. Short the fixture with a very low-resistance "short circuit".
- b. Press the keys: [1] [6] [8] [9] [=] [SHIFT] [SHORT]. (A 5 in each, left and right displays, and the GO indicator should be lit, confirming this step.) Keep away from test fixture, as in step d above.
- c. Press the START button. The GO indication disappears.
- d. Wait for the GO indicator to be lit again (approximately 10 seconds).  
The RLC display should be .00000 (ohms or mH).
- e. Disconnect the short circuit.

*DQ in PPM.* Press [SHIFT] [DQ in PPM] keys if necessary to light this indicator.

### 5.9.3 Recalibration for Range 4

- a. Connect the 24.9-ohm calibration resistor to the Digibridge test fixture.

b. Enter the known parameters of the calibration resistor as in the following example, based on the values R = 24.895 ohms and Q = 15 ppm. (NOTES: The Digibridge will accept six digits for R, even though only five will be displayed. The Q is associated with "bin 00", and its value must be preceded with "-" if the known Q is negative. )

Select ENTER with [FUNCTION] key and CONTINUOUS with [MEASURE MODE] key.

Press [4] [=] [SHIFT] [SPECIAL] [1]

Press [2][4][.][8][9][5][=][SHIFT][NOM VALUE]

NOTE: the calibration resistance value should appear in the left display. The DQ in PPM indicator must be lit.

Press [1][5][=][SHIFT][BIN NO] [0] [0]

NOTE: The calibration Q value should appear in the right-hand display.

NOTE: The calibration Q value should appear in the right-hand display.

c. Enable and execute the recalibration for this range as follows. (The following keystrokes are the same for any range.)

Select MEASURE with the [FUNCTION] key and TRIGGERED with [MEASURE MODE] key. Press [1][6][8][9][=][1][SHIFT][CALIBRATE]

NOTE: The GO indicator being lit and a 6 in the left and a 6 in the right displays confirm that calibration is enabled.

Press START (The GO indicator remains unlit while calibration proceeds.)

Keeping hands away from the test fixture, wait until the GO indicator is lit again. This completes recalibration of one range.

d. Check as follows that the Digibridge operates properly with the recalibration.

Select CONTINUOUS with the [MEASURE MODE] key.

The Digibridge should measure the calibration resistor like any ordinary resistor and display its R and Q (ppm) values. The Q display can be expected to "jump" a bit. (Precision and repeatability are in the order of 5 ppm). Also, the NO-GO indicator will probably be lit; this is normal.

e. Disconnect the calibration resistor from the test fixture.

### 5.9.4 Recalibration for Range 3

a. Connect the 374-ohm calibration resistor to the Digibridge test fixture.

b. Enter the known parameters of the calibration resistor as in the following example, based on the values  $R = 374.06$  ohms and  $Q = 5$  ppm. (NOTES: The Digibridge will accept six digits for R, even though only five will be displayed. The Q is associated with "bin 00", and its value must be preceded with "." if the known Q is negative.)

Select ENTER with [FUNCTION] key and verify that MEASURE MODE is CONT.

Press [3][=][SHIFT][SPECIAL][1]

Press [3][7][4] [.] [0] [6] [=] [SHIFT] [NOM VALUE]

NOTE: the calibration resistance value should appear in the left display. The DQ in PPM indicator must be lit.

Press [5] [=] [SHIFT] [BIN NO] [0][0]

NOTE: the calibration Q value should appear in the right-hand display.

c. Enable and execute the recalibration for this range as follows. (The following keystrokes are the same for any range.)

Select MEASURE with the [FUNCTION] key and TRIGGERED with [MEASURE MODE] key.

Press [1][6][8][9][=][1][SHIFT][CALIBRATE]

NOTE: The GO indicator being lit and a 6 in the left and a 6 in the right displays confirm that calibration is enabled.

Press START (The GO indicator remains unlit while calibration proceeds.)

Keeping hands away from the test fixture, wait until the GO indicator is lit again. This completes recalibration of one range.

d. Check as follows that the Digibridge operates properly with the recalibration.

Select CONTINUOUS with the [MEASURE MODE] key.

The Digibridge should measure the calibration resistor like any ordinary resistor and display its R and Q (ppm) values. The Q display can be expected to "jump" a bit. (Precision and repeatability are in the order of 5 ppm). Also, the NO-GO indicator will probably be lit; this is normal.

e. Disconnect the calibration resistor from the test fixture.

### 5.9.5 Recalibration for Range 2

a. Connect the 5.97-kilohm calibration resistor to the Digibridge test fixture.

b. Enter the known parameters of the calibration resistor as in the following example, based on the values R = 5.9581 kilohms and Q = .22 ppm. (NOTES: The Digibridge will accept six digits for R, even though only five will be displayed. The Q is associated with "bin 00", and its value must be preceded with "." if the known Q is negative.)

Select ENTER with [FUNCTION] key and verify that MEASURE MODE is CONT.

Press [2][=][SHIFT][SPECIAL][1]

Press [5][.][9][5][8][1][=][SHIFT][NOM VALUE]

NOTE: the calibration resistance value should appear in the left display. The DQ in PPM indicator must be lit.

Press [-][2][2][=][SHIFT][BIN NO][0][0]

NOTE: the calibration Q value should appear in the right-hand display.

c. Enable and execute the recalibration for this range as follows. (The following keystrokes are the same for any range.)

Select MEASURE with the [FUNCTION] key and TRIGGERED with [MEASURE MODE] key.

Press [1][6][8][9][=][1][SHIFT][CALIBRATE]

NOTE: The GO indicator being lit and a 6 in the left and a 6 in the right displays confirm that calibration is enabled.

Press START (The GO indicator remains unlit while calibration proceeds.)

Keeping hands away from the test fixture, wait until the GO indicator is lit again. This completes recalibration of one range.

d. Check as follows that the Digibridge operates properly with the recalibration.

Select CONTINUOUS with the [MEASURE MODE] key.

The Digibridge should measure the calibration resistor like any ordinary resistor and display its Rand Q (ppm) values. The Q display can be expected to "jump" a bit. (Precision and repeatability are in the order of 5 ppm). Also, the NO-GO indicator will probably be lit; this is normal.

e. Disconnect the calibration resistor from the test fixture.

### 5.9.8 Recalibration for Range 1

a. Connect the 95.3-kilohm calibration resistor to the Digibridge test fixture.

b. Enter the known parameters of the calibration resistor as in the following example, based on the values R = 94.986 kilohms and Q = -280 ppm. (NOTES: The Digibridge will accept six digits for R, even though only five will be displayed. The Q is associated with "bin 00", and its value must be preceded with "-" if the known Q is negative.)

Select ENTER with [FUNCTION] key and verify that MEASURE MODE is CONT.

Press [1][=][SHIFT][SPECIAL][1]

Press [9][4][.][9][8][6][=][SHIFT][NOM VALUE]

NOTE: the calibration resistance value should appear in the left display. The DQ in PPM indicator must be lit.

Press [-][2][8][0][=][SHIFT][BIN NO] [0] [0]

NOTE: the calibration Q value should appear in the right-hand display.

c. Enable and execute the recalibration for this range as follows. (The following keystrokes are the same for any range.)

Select MEASURE with the [FUNCTION] key and TRIGGERED with [MEASURE MODE] key. Press

Press [1][6][8][9][=][1][SHIFT][CALIBRATE]

NOTE: The GO indicator being lit and a 6 in the left and a 6 in the right displays confirm that calibration is enabled.

Press START (The GO indicator remains unlit while calibration proceeds.)

Keeping hands away from the test fixture, wait until the GO indicator is lit again. This completes recalibration of one range.

d. Check as follows that the Digibridge operates properly with the rccalibration.

Select CONTINUOUS with the [MEASURE MODE] key.

The Digibridge should measure the calibration resistor like any ordinary resistor and display its Rand Q (ppm) values. The Q display can be expected to "jump" a bit. (Precision and repeatability are in the order of 5 ppm). Also, the NO-GO indicator will probably be lit; this is normal.

e. Disconnect the calibration resistor from the test fixture.

### 5.9.7 Frequency Calibration

a. If frequency calibration is not necessary (refer to "Decision ...", in paragraph 5.9.1), omit the procedures of paragraph 5.9.7. If necessary at all, these steps should be done before paragraphs 5.9.2 through 5.9.6.

b. Connect the counter as follows to measure the period of the test frequency, nominally 1 kHz. If the Digibridge is not disassembled, provide for a ground connection as follows. (Otherwise, see NOTE below.) Insert a 6-32 (1/2 -inch long) screw into the tapped hole at the right-hand end of the Digibridge's test fixture (tighten

gently). Connect the ground return of the counter's probe to this screw.

Insert the short-circuit wire used above (for example) into the right-hand slot of the test fixture only. Connect the counter's probe to this wire.

NOTE: If calibration is being done with the main board out of the cabinet, a more convenient ground connection is found near the front edge of the board at a guard-jumper terminal labeled E1 on the board (DUT CONNECTOR GND on the schematic diagram).

b. Measure the test signal frequency, preferably as a period and calculate its reciprocal.

For example, if the period is 1.000007 ms, the frequency is 0.999993 kHz.

c. Calculate the frequency correction "c" (error) in ppm, as follows:

$$c = \frac{(\text{measured frequency}) - 1.000000 \text{ kHz}}{1 \text{ kHz}} \times 1,000,000 .$$

For example:  $c = (0.999993 - 1.000000) \times 1,000,000 = -7 \text{ ppm}$ .

d. Enter the frequency correction "c" (error) in ppm, as follows. The allowable range of entry is -99 to +99

For example, if the value of "c" is -7 ppm:

Select ENTER function and press:

[-][7][=][SHIFT][SPECIAL][0]

Notice that the correction "C" appears in the left display, followed by a decimal point. The correction has NOT been entered yet. Confirm the value. Then continue the entry process by pressing:

[1][6][8][9]

The decimal point should disappear, indicating that the correction has been entered.

e. Confirm normalcy as follows:

Press [1][=][SHIFT][FREQUENCY] (The left display should now be 1)

Press [1][=][SHIFT][VOLTAGE] (The left display should be 1)

f. Now continue with the zeroing and range recalibration procedures, starting at paragraph 5.9.2.

### 5.9.8 Frequency Correction K Factor Procedure

The Frequency K Factor correction is for small changes related to loading errors and timing errors with respect to frequency. There is one K factor for each of the four ranges.

These corrections are determined during initial factory calibration and the procedure is not necessary to repeat unless the contents of the RAM have been lost due to battery failure or other corruption.

This procedure is not recommended during normal recalibration (see paragraphs 5.9.1 -5.9.6).

#### PROCEDURE:

a) Reset K factors to typical values (required as a starting reference).

1. Press [FUNCTION] to ENTER
2. Press [1][6][8][9][.][9][SHIFT][SPECIAL][SHIFT]
3. Press [START] (to indicate storage of K factors)

b) Check K factors:

1. Press [R/Q]
2. For RANGE 1 press [1][6][8][9][.][5][SHIFT][SPECIAL][SHIFT]  
If units are ohms display will be -238.42 ( $= -238.42 \times 10^{-9}$ )  
If units are Kohms display will be -.23842 ( $= -.23842 \times 10^{-6}$ )
3. For RANGE 2 press [1][6][8][9][.][6][SHIFT][SPECIAL][SHIFT]  
Ohms = -11.176  
Kohms = -.01118
4. For RANGE 3 press [1][6][8][9][.][7][SHIFT][SPECIAL][SHIFT]  
Ohms = 4.6000  
Kohms = .00460
5. For RANGE 4 press [1][6][8][9][.][8][SHIFT][SPECIAL][SHIFT]  
Ohms = 5.5879  
Kohms = .00559

c) Calibrate all 4 ranges of the digibridge as described in paragraphs 5.9.2 through 5.9.6.

d) Determine new K factors.

In order to calculate the K factor it is necessary to measure the delta% value of the calibration resistors from 1 kHz to 20 kHz for range 1 and from 1 kHz to 100 kHz for ranges 2, 3, and 4.

1. Select FUNCTION            ---ENTER  
   DISPLAY            ---VALUE  
   MEASURE RATE    ---SLOW  
   MEASURE MODE    ---CONTINUOUS

2. Select the frequency of 1 kHz by pressing:

[1] [=] [SHIFT] [FREQUENCY]

3. Select the range to be calibrated by pressing:

[x] [=] [SHIFT] [SPECIAL] [1] (where x = 1, 2, 3, or 4)

4. Select FUNCTION ---MEASURE

Insert the calibration resistor for the range to be calibrated.

(95 Kohm for range 1, 6 Kohm for range 2, 374 ohm for range 3, or 25 ohm for range 4). NOTE: For range 1 only, the 95 Kohm standard may only give 4 digits of resolution. Perform the following to get 5 digits:

Select FUNCTION ---ENTER.

Enter a nominal value by pressing:

[9] [5] [=] [SHIFT] [NOM VAL]

Select FUNCTION ---MEASURE

DISPLAY ---DELTA%

DISPLAY ---VALUE

Record the average value standard resistor as indicated on the Digibridge display.

For example: For range 1, the reading might be 95.286 Kohm.

5. Select FUNCTION -ENTER

Enter as a nominal value the reading noted above. For example:

Range 1, press [9] [5] [.] [2] [8][6] [=] [SHIFT] [NOM VAL]

6. Change the frequency to 20 kHz for range 1, 100 kHz for ranges 2, 3, 4.

For example: Range 1 press [2][0][=][SHIFT][FREQUENCY]

7. Determine the delta% reading as follows:

Select FUNCTION ---MEASURE

DISPLAY ---DELTA%

Note the average reading. For example: Range 1 may be -.8849.

8. Calculate the new K factor as follows:

$$K_b = \frac{\text{delta}\%}{K_f} + K_a \left( 1 + \frac{\text{delta}\%}{100} \right)$$

where  $K_b$  = K factor

$K_a$  = typical correction factor (refer to step b, use the ohm values for all ranges)

delta% = % change 1 kHz value to higher frequency.

$K_f$  is Frequency Factor Range 1 = .001579 (for 20 kHz)

Range 2,3,4 = .03948 (for 100 kHz)

For example: Range 1 calculation:

$$K_b = \frac{- .8849}{.001579} + (-238.42) \left( 1 + \frac{- .8849}{100} \right)$$

$$K_b = -798.83$$

e) Store the new correction factor for each range.

Select FUNCTION --ENTER

Select DISPLAY --VALUE

Select R/Q --until ohms LED is on

Enter the new K factor as a nominal value. For

example: Range I, press:

[-][7][9] [8] [.] [8] [3] [=] [SHIFT] [NOM VAL]

Store the K factor for each range:

For range I, press [1][6][8][9][.][1][=][SHIFT][SPECIAL][SHIFT]

For range 2, press [1][6][8][9][.][2][=][SHIFT][SPECIAL][SHIFT] For range 3, press

For range 3 press [1][6][8][9][.][3][=][SHIFT][SPECIAL][SHIFT]

For range 4 press [1][6][8][9][.][4][=][SHIFT][SPECIAL][SHIFT]

Select MEASURE RATE --MEDIUM to FAST to SLOW

r) Once the K factors have been determined and stored for all four ranges (step d through e) repeat the recalibration procedure for all ranges (see paragraphs 5.9.2 through 5.9.6).

## 5.10 INTERNAL SETTINGS

### 5.10.1 Address for IEEE-488 Interface

Each device (instrument) in a system linked by an IEEE-488 bus must have its own address (except in the simple case of a single "talker only" with one or more "listeners" that are always listening). The initial setting of address, provided by the factory, in the interface option of this Digibridge, is 00011. If the requirements of a system installation make it necessary to change the Digibridge address, use the following procedure. Refer to paragraph 2.8.4 for further comments and a table of possible addresses.

a. Remove the interface option, after removing the 2 large screws with resilient washers in the rear panel. See Figure 1-2

### CAUTION

Observe the handling precautions given at the beginning of the Service Section.

b. Find S2 which is located at the end of the interface option board, about 3 cm (1 in.) from the TALK switch S1. If S2 is covered, lift the cover off, exposing the "DIP" switch, which has 2 rows of 6 tiny square pads with numbers 1 thru 6 between the rows. The five device-dependent bits of the address are set by this switch.



c. Set in the desired bits as follows. To enter logical 1's, depress pads nearest the end of the board. To enter logical 0's, depress pads on the other side of the "DIP" switch, the side marked with a + sign. The address is read from 5 to 1 (not using 6). Thus, for example, to set up the address 00011, enter 0's at positions 5, 4, 3; enter 1's at positions 2, 1. (This makes the talk address "C" and the listen address "#".)

NOTE: Strictly speaking, the address includes more; S2 determines only the device--dependent bits of the address. You cannot choose talk and listen addresses separately, only as a pair. The list of possible pairs is shown in Table 2-3. In the above example, the remote message codes MLA and MTA are X0100011 and X1000011, respectively. Thus the listen address and the talk address are distinguished, although they contain the same set of device--dependent bits, which are set into S2.

d. Replace the interface option assembly in its former place. Reassembly note: align board edges carefully with connector and guide that are inside of instrument, while pushing interface option into position.

### 5.10.2 Making +5 Volts Available via the Handler Interface Connector

A five--volt low-power dc bus is normally brought out via pin 10 of the handler interface connector. This bus is useful to supply voltage for opto-couplers in a handler. NOTE: Do NOT attempt to draw more than 25 mA. The bus is connected via a factory-installed jumper, which is accessible as follows.

a. Remove the interface option, after removing the 2 large screws with resilient washers in the rear panel. See Figure 1-2.

#### CAUTION

Observe the handling precautions given at the beginning of the Service Section.

b. Find wire tie points WT2 and WT3, on the circuit board, near the handler interface connector.

c. If the jumper is missing, connect a wire jumper between WT2 and WT3.

d. Replace the interface option assembly in its former place. Reassembly note: align board edges carefully with connector and guide that are inside of instrument, while pushing interface option into position.

---

# Parts Lists and Diagrams – Section 6

---

6.1 GENERAL	6-1
6.2 REFERENCE DESIGNATIONS	6-1
6.3 DIAGRAMS	6-5
Figure 6-1. 1689 Front View, showing mechanical parts	6-2
Figure 6-1A. 1689M Front View, showing mechanical parts	6-4
Figure 6-2. 1689 Rear View, showing mechanical parts	6-2
Figure 6-2A. 1689M Rear View, showing mechanical parts	6-4
Federal Supply Code for Manufacturers	6-6
Figure 6-3. Main Board, schematic sheet 1, 1689-4702-SD	6-7
Figure 6-4. Main Board, layout sheet 1 . . . 1689-4702	6-8
Figure 6-5. Main Board, layout sheet 2 . . . 1689-4702	6-9
Figure 6-6. Main Board, schematic sheet 2, 1689-4702-SD	6-10
Figure 6-7. Main Board, schematic sheet 3, 1689-4702-SD	6-11
Figure 6-8. Main Board, schematic sheet 4, 1689-4702-SD	6-12
Figure 6-9. Main Board, schematic sheet 5, 1689-4702-SD	6-13
Figure 6-10. Main Board, schematic sheet 6, 1689-4702-SD	6-14
Figure 6-11. Main Board, schematic sheet 7, 1689-4702-SD	6-14
Figure 6-12. Power Supply, assembly . . . . 1689-2005	6-15
Figure 6-13. Power Supply Board, layout . . . 1657-4720	6-16
Figure 6-14. Power Supply, schematic . . . . 1689-2005-SD	6-16
Figure 6-15. Display Board, layout . . . . . 1658-4715	6-17
Figure 6-16. Display Board, schematic . . . . 1658-4715-SD	6-18
Figure 6-17. High-Speed Interface Board, layout sheet 1, 1689-4720	6-19
Figure 6-18. High-Speed Interface Board, layout sheet 2, 1689-4720	6-19
Figure 6-19. High-Speed Interface, schematic sheet 1, 1689-4720-SD	6-20
Figure 6-20. High-Speed Interface, schematic sheet 2, 1689-4720-SD	6-21
Figure 6-21. High-Speed Interface, schematic sheet 3, 1689-4720-SD	6-22
Figure 6-22. Interface Option Board, layout, 1658-4720-1D	6-23
Figure 6-23. Interface Option, schematic, 1658-4720-2DA	6-24
Figure 6-24. Keyboard Module, assembly . . . 1687-4200	6-25
Figure 6-25. Keyboard Indicators, detail . . 1687-4710-1D	6-25
Figure 6-26. Keyboard, schematic . . . . . 1687-4710-2D	6-26

## 6.1 GENERAL

This section contains the parts lists, circuit board layout drawings, and schematic diagrams for the instrument. Refer to Section 4 for the functional block diagram and Section 5 for further details about part locations.

## 6.2 REFERENCE DESIGNATIONS

Each electrical component part on an assembly is identified on the equipment and drawings by means of a reference designator comprised of letters and numbers. Component parts on a circuit board or assembly are classified by the letter or letters of the reference designators (R for resistor, C for capacitor, etc) and individually identified by the numerical part of the reference designator (R1 for the first resistor, R2 for the second, etc). Some of the less obvious designator letters are. DS or CR for indicator light, Q for transistor, U for integrated-circuit device, WT for wire tie point, J or P for connector, and Z for network.

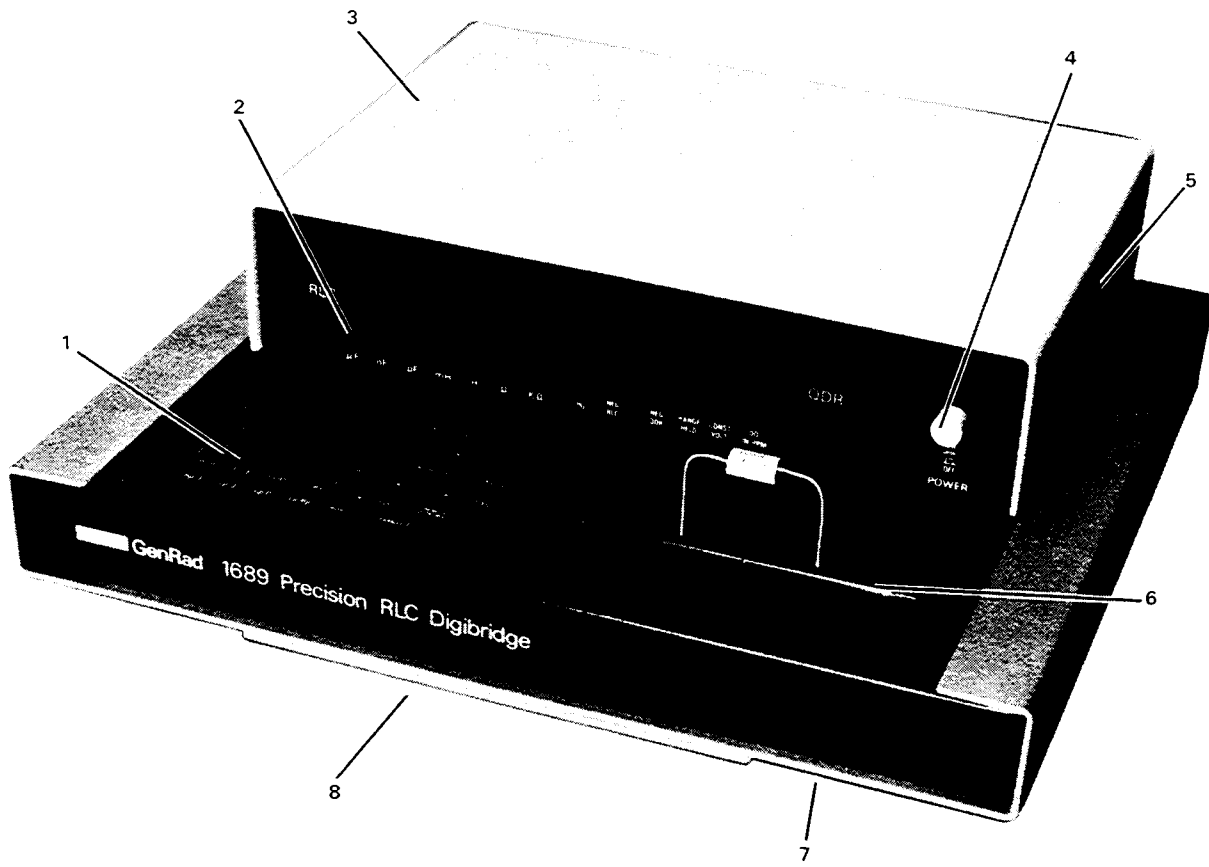

Figure 6-1. Front view of 1689, showing replaceable mechanical parts.

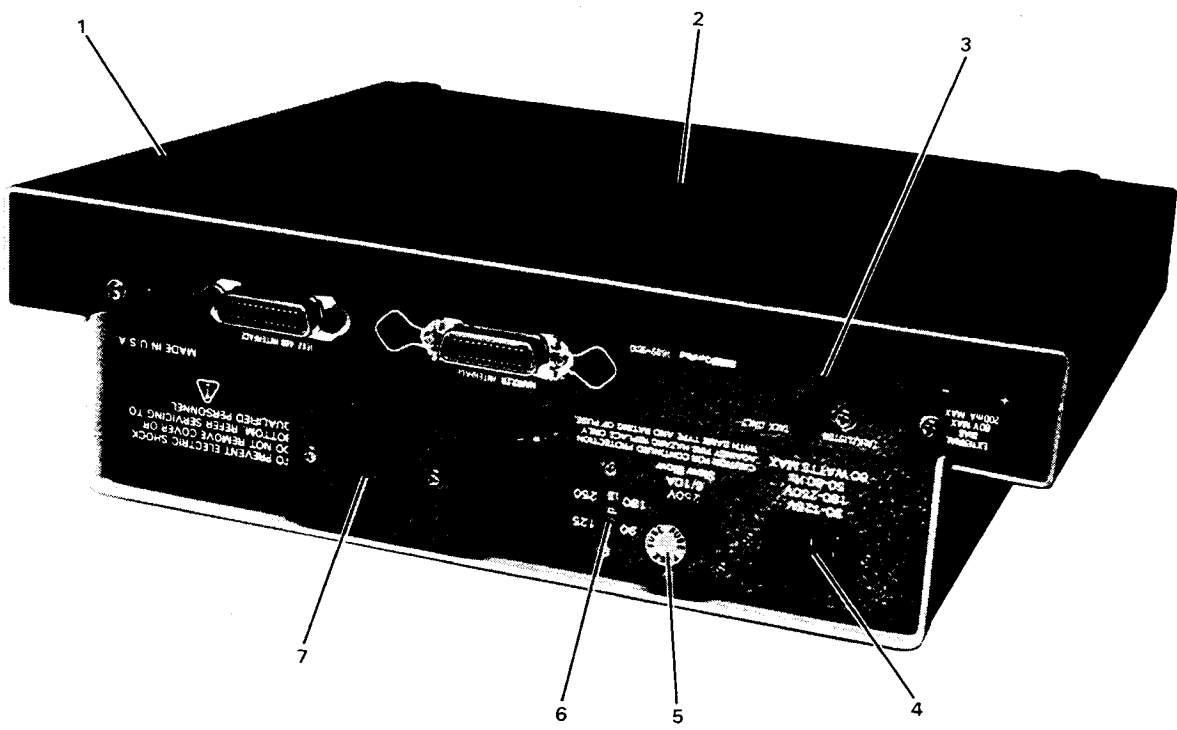

Figure 6-2. Rear view of 1689, showing replaceable mechanical parts.

MECHANICAL PARTS LIST FOR 1689 DIGIBRIDGE

FRONT (Figure 6-1)

Item	Description	GenRad Part	Mftr	Mftr Part No.
1	Keyboard top plate	1689-8040	24655	1689-8040
2	Display panel	1689-7000	24655	1689-7000
3	Top cover	1689-8003	24655	1689-8003
4	Switch actuator rod assembly	1689-2006	24655	1689-2006
5	Air filter (washable, dry type)	5270-5456	24655	5270-5456
6	Test fixture upper assembly	1689-2000	24655	1689-2000
	(includes dross tray	1657-7700	24655	1657-7700
	and foamed plastic pad)	1657-7800	24655	1657-7800
-	Test fixture contacts (4 required; included on 1689-4702 board) each:	1689-1015	24655	1689-1015
7	Card Pan	1658-8200	24655	1658-8200
8	Instruction card	1689-0110	24655	1689-0110

REAR (Figure 6-2)

Item	Description	GenRad Part	Mftr	Mftr Part No.
1	Foot (4 required) each:	5260-2051	24655	5260-2051
2	Bottom shell (card pan not shown)	1657-8000	24655	1657-8000
3	(High-speed meas interface option shown) Blank plate used if no option present:	1658-8040	24655	1658-8040
4	Power connector J101	4240-0250	82389	EAC-302
5	Fuse extractor post F1	5650-0100	75915	342-004
6	Line voltage switch S2	7910-0832	82389	11A-1266
7	Cover (over transistor U1)	1657-8120	24655	1657-8120

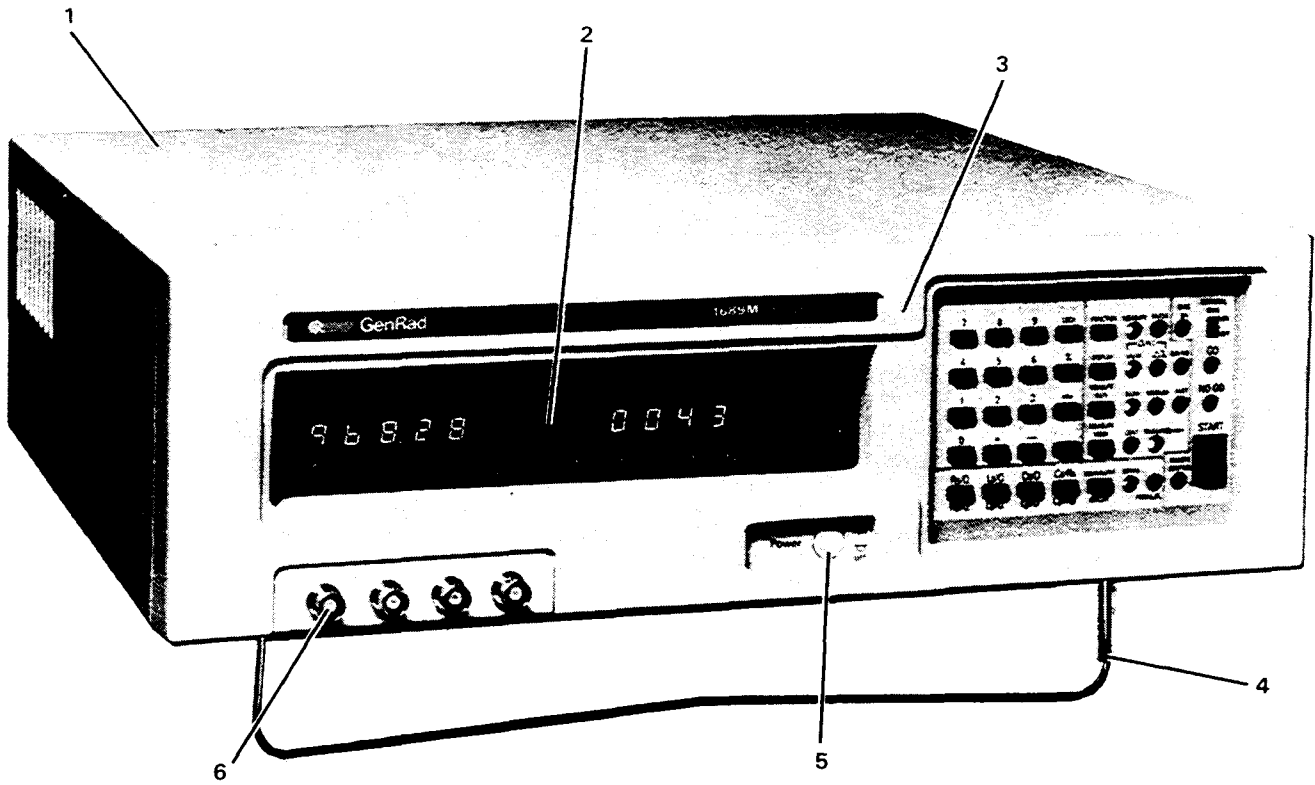

Figure 6-1(A). The 1689M, front view, showing replaceable mechanical parts.

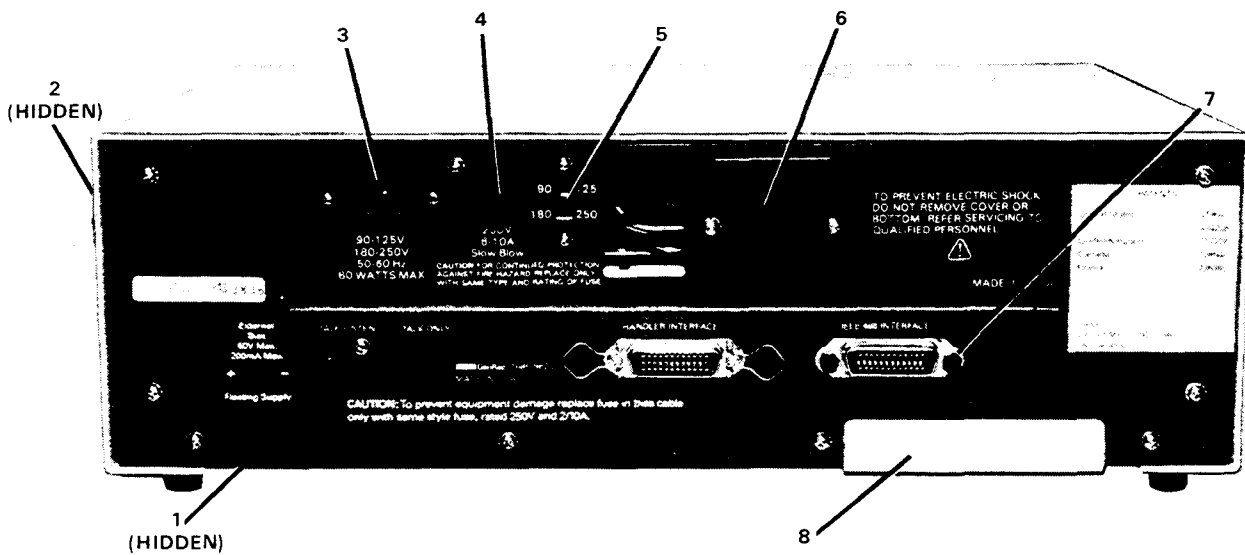

Figure 6-2(A). The 1689M, rear view, showing replaceable mechanical parts.

## MECHANICAL PARTS LIST FOR 1689M

### FRONT (Figure 6-1A)

Item	Description	GenRad Part	Mftr	Mftr Part No.
1	Cover	1689-8304	24655	1689-8304
2	Display window	1689-8308	24655	1689-8308
3	Bezel (plastic front piece)	1689-8305	24655	1689-8305
4	Set of four feet and tilting bail	4171-0445	24655	4171-0445
5	Switch actuator rod assembly (POWER)	1689-1001	24655	1689-1001
6	Single BNC connector (receptacle)	4230-2301	24655	4230-2301

### REAR (Figure 6-2A)

Item	Description	GenRad Part	Mftr	Mftr Part No.
1	Bottom access door	1689-8319	24655	1689-8319
2	Air filter (washable, dry type)	5270-5456	24655	5270-5456
3	Power connector J101	4240-0250	82389	EAC-302
4	Fuse extractor post F1	5650-0100	75915	342-004
5	Line voltage switch S2	7910-0832	82389	11A-1266
6	Cover (over transistor U1)	1657-8120	24655	1657-8120
7	(High-speed meas interface option shown)			
	Blank plate used if no option present:	1658-8040	24655	1658-8040
8	Blank plate for rear position of BNCs	1689-8312	24655	1689-8312

### 6.3 DIAGRAMS

In this section, the schematic diagrams are located on right-hand fold-out pages for convenience. The associated parts list, layout drawing, assembly view, etc for each schematic diagram are located on the apron of the same page, the facing page, or otherwise nearby.

**FEDERAL SUPPLY CODE**  
**FOR MANUFACTURERS**  
**From Defense Logistics Agency Microfiche**  
**H4-2 SB 708-42 GSA-FSS H4-2**

Ref FMC Column  
in Parts Lists

Code	Manufacturer	Code	Manufacturer	Code	Manufacturer	Code	Manufacturer
00136	McCov Electrs., Mt. Holly Springs, PA 17065	15605	Cutler Hammer, Milwaukee, WI 53202	56289	Sprague, North Adams, MA 01247	80894	Pure Carbon, St. Marys, PA 15857
00192	James Mtg., Chicago, IL 60181	15782	Houston Inst., Bellaire, TX 77401	57171	Stimpson, Bayport, NY 11705	81030	Int'l Inst., Orange, CT 06477
00194	Waisco Electrs., Los Angeles, CA 90018	15801	Fenwal Electrs., Framingham, MA 01701	58553	Superior Valve, Washington, PA 15301	81073	Grayhill, LaGrange, IL 60525
00327	Weliwyn Inntst., Westlake, OH 44145	15819	Sinclair & Rush, St. Louis, MO 63111	59730	Thomas & Betts, Elizabeth, NJ 07207	81143	Isolantec, Sterling, NJ 07980
00434	AMPerox., New Bedford, MA 02745	16037	Source Pine Mica, Spruce Pine, NC 28777	59875	TRW, Cleveland, OH 44117	81312	Winchester, Oakville, CT 06779
00656	Schwarz, New Bedford, MA 02745	16068	Intrnt Diode, Jersey City, NJ 07304	60039	Torrington, Torrington, CT 06790	81349	Military Specifications
00779	KAP Inc., Harrisburg, PA 17105	16179	Omniv Spectra, Farmington, MI 48024	61007	Towmsnd, Braintree, MA 02184	81350	Joint Army-Navy Specifications
01009	Alden Products, Brockton, MA 02413	16179	Astrolab, Linden, NJ 07036	61637	Union Carbide, New York, NY 10017	81483	Int'l Rectifier, El Segundo, CA 90245
01121	Helen Bradley, Milwaukee, WI 53204	16352	Cioba, Fairlawn, NJ 07410	61884	United Carr. East, Boston, MA	81741	Chicago Lock, Chicago, IL 60641
01255	Liton Ind., Beverly Hills, CA 90213	16485	Sterling Inst., New Hyde Park, NY 11040	63060	Victoreen, Cleveland, OH 44104	81831	Fittron, Flushing, NY 11354
01281	TRW, Lawndale, CA 90260	16636	Indiana General, Oglesby, IL 61348	63743	Ward Leonard, Mt. Vernon, NY 10550	81840	Ledex, Dayton, OH 45402
01295	Tl., Dallas, TX 75222	16758	Delco, Kokomo, IN 46901	65083	Westinghouse, Bloomfield, NJ 07003	81860	Barry Wright, Watertown, MA 02172
01526	GE, Waynesboro, VA 22960	16950	Precision Dynamics, Burbank, CA 91504	65092	Weston, Newark, NJ 07114	82119	Sylvania, Emorium, PA 15834
01930	Amerock, Rockford, IL 61101	16952	Amer Micro Devis., Summersville, SC 29483	70106	Acushnet Cap., New Bedford, MA 02742	82227	No. Amer. Philips, Chesire, CT 06410
01963	Cherry Electrc., Waukegan, IL 60085	17117	Elctrc Molding, Woonsocket, RI 02895	70109	Adams & Westlake, Elkhart, IN 46514	82273	In Pattern & Model, LaPorte, IN 46350
02111	Spectrol Electrs., City of Industry, CA 91745	17540	Mohawk Spring, Schiller Park, IL 60176	70417	Chrysler, Detroit, MI 48231	82389	Switchcraft, Chicago, IL 60630
02114	Ferrocube, Saugerter, NY 12477	17745	Angstrom Precsn., Hagerstown, MD 21740	70485	Atlantic India Rubber, Chicago, IL 60607	82567	Reeves Hoffman, Carlisle, PA 17013
02629	Fenwall Lab., Morton Grove, IL 60053	17771	Singer, Somerville, NJ 08876	70563	Amperite, Union City, NJ 07087	82647	Matsak & Controls, Attleboro, MA 02703
02639	GE, Schenectady, NY 12307	17850	Zitex, Concord, CA 94520	70611	Caro Coil, Providence, RI 02905	82807	Milwaukee Restor., Milwaukee, WI 53204
02660	Amphenol, Broadview, IL 60153	17856	Siliconix, Santa Clara, CA 95054	70892	Bead Check, Bridgeport, CT 06605	82877	Rotron, Woodstock, NY 12498
02735	RCA, Somerville, NJ 08876	18324	Synetics, Sunnyside, CA 94086	70903	Balden, Chicago, IL 60644	82901	IN General Magnet, Valparaiso, IN 46383
02768	Fasta., Des Plains, IL 60016	18542	New Prod Eng., Wabash, IN 46992	71126	Bronson, Beacon Falls, CT 06403	83003	Vero, Garland, TX 75040
03042	Carter Ink., Cambridge, MA 02142	18677	Scanba., El Monte, CA 91731	71279	Cambridge Thermionic, Cambridge, MA 02138	83014	Hartwell, Placenta, CA 92670
03508	GE, Syracuse, NY 13201	18736	Computer Dode., S. Fairlawn, NJ 07936	71294	Canfield, Clifton Forge, VA 24422	83033	Messner, Mt Carmel, IL 62863
03550	Vanguard Electrs., Inglewood, CA 90302	18795	Cycon, Sunnyside, CA 94086	71400	Bussmann, St. Louis, MO 63107	83058	Carr Fastener, Cambridge, MA 02142
03636	Grayburne, Yonkers, NY 10701	18911	Durant, Watertown, WI 53094	71450	CTS, Elkhart, IN 46514	83186	Victory Eng., Springfield, NJ 07081
03877	Transitron Electrs., Wakefield, MA 01880	19178	Zero, Monson, MA 01057	71468	Cannon, Los Angeles, CA 90031	83259	Parker Seal, Cuervo City, CA 90231
03888	KDI Pyrofilm, Whippany, NJ 07981	19209	GE, Ganesville, FL 32601	71482	Clare, Chicago, IL 60645	83330	H.H. Smith, Brookline, NY 11207
03911	Clarex, New York, NY 10001	19373	Easton, Haverhill, MA 01830	71560	Centralab, Milwaukee, WI 53212	83361	Bearing Spclty., San Francisco, CA
04009	Arrowhead, Hartford, CT 06106	19396	Paktron, Vienna, VA 22180	71899	Continental Carbon, New York, NY	83587	Solar Electrc., Warren, PA 16365
04643	Diptronics, Alberton, NY 11507	19617	Captron, Chicago, IL 60622	71707	Crescent Box, Philadelphia, PA 19134	83594	Burroughs, Plainfield, NJ 07061
04713	Motorola, Phoenix, AZ 85008	19644	LRC Electrs., Horsheds, NY 14845	71729	Chicago Min. Lamp, Chicago, IL 60640	83740	Union Carbide, New York, NY 10017
04919	Component Mfg., W. Bridgewater, MA 02379	19701	Electra, Independence, KS 67301	71744	Chicago Min. Lamp, Chicago, IL 60640	83766	Mass Eng'g., Quincy, MA 02171
05079	Tansator Electrs., Bennington, VT 05201	20093	Elect Inds., Murray Hill, NJ 07974	71785	Cinch, Chicago, IL 60624	83781	National Electcs., Geneva, IL 60134
05245	Corcom, Chicago, IL 60639	20754	KMC., Long Valley, NJ 07853	71823	Dann., Downey, CA 90241	84411	TRW, Ogalela, NB 69153
05276	ITT Electronics, Pomona, CA 91766	21335	Fafnir Bearing, New Britain, CT 06650	72136	Electromotive, Wilimantic, CT 06226	84835	Lehigh Metals, Cambridge, MA 02140
05402	Controls Co. of Amer., Melrose Pk., IL 60160	21688	Raytheon, Norwood, MA 02062	72228	Continental Ser., New Bedford, MA 02742	84970	Sarkes Tarzian, Bloomington, IN 47401
05574	Viking Ind., Chatsworth, CA 91311	21759	Lenox Fugle, Watchung, NJ 07060	72259	Nytronics, Berkeley Hts, NJ 07922	84971	TA Mfg., Los Angeles, CA 90039
05624	Barber Colman, Rockford, IL 61101	22526	Berg Electrs., New Cumberland, PA 17070	72619	Diagnost., Brooklyn, NY 11237	86024	Kapco, Flushing, NY 11352
05748	Barna Mfg., Mansfield, OH 44901	22589	Electro Space Fabrcrtr., Topton, PA 19562	72689	General Inst., Newark, NJ 07104	86420	Payson Casters, Gurnee, IL 60031
05820	Wakefield Eng., Wakefield, MA 01880	22753	UID Electcs., Hollywood, FL 33022	72795	Drake, Chicago, IL 60631	86577	Pre Metal Prod., Stoneham, MA 02180
06383	Panduit, Tinley Pk., IL 60477	23336	Wavetek, San Diego, CA 92112	72794	Dzus Fastener, W. Hill, NY 11795	86684	RC, Harrison, NY 07029
06406	Trustco & Maclean, Waterbury, CT 06708	23342	Avnet Electcs., Franklin Park, IL 60131	72825	Eloy, Philadelphia, PA 19144	86687	REC, New Rochelle, NY 10801
06665	Precision Monitor, Santa Clara, CA 95050	23336	Pamotor, Bingham, CA 94110	72862	Elite Sloop Nut, Union, NJ 07083	86800	Conn Electcs., Brooklyn, NY 11222
06743	Clevite, Cleveland, OH 44110	24351	Indiana Grrl Electrc., Keesby, NJ 08832	72982	Eric, Erie, PA 16512	88140	Cutler Hammer, Lincoln, IL 62856
06795	WLS Stamp, Cleveland, OH 44104	24355	Analog Devis., Cambridge, MA 02142	73445	Amperex Electrs., Hicksville, NY 11801	88204	GTE Sylvania, Ipwitich, MA 01938
06915	Riecho Plstc., Chicago, IL 60646	24444	General Semicond., Tempe, AZ 85281	73559	Carling Electrc., Hartford, CT 06110	88219	Gould Nat Battery, Trenton, NJ 08607
06928	Teledyne Kntcs., Soland Bch, CA 92075	24446	GE, Schenectady, NY 12305	73690	Eco Resistor, New York, NY	88419	Cornell Dubilier, Fuquay Varine, NC 27526
06978	Roadin Electrs., Nashville, TN 37210	24454	GE, Syracuse, NY 13201	73803	Tl., Attleboro, MA 02703	88627	K&G Mfr., New York, NY
07047	Ross Milton, Southampton, PA 18966	24455	GE, Cleveland, OH 44112	73899	JFD Electcs., Brooklyn, NY 11219	89265	Potter & Brumfield, Princeton, IN 47671
07126	Digirhan, Pasadena, CA 91105	24602	EMC Technly., Cherry Hill, NJ 08034	73957	Groov-Pan., Ridgefield, NJ 07657	89482	Holtzer Cabot, Boston, MA 02119
07127	Eagle Signal, Baraboo, WI 53913	24655	Eng Rad., Concord, MA 01742	74193	Heinemann, Trenton, NJ 08602	89665	United Transformer, Chicago, IL
07123	Cinch Graphix, City of Industry, CA 91744	24758	Lenox Fugle, S. Plainfield, NJ 07080	74199	Quam Nichol., Chicago, IL 60637	89870	Berkshire Transformer, Kent, CT 06757
07261	Avnet, Culver City, CA 90230	25289	Vacrite, Berkeley, CA 94710	74445	Huibel, Stratford, CT 06497	90201	Mallory Cap., Indianapolis, IN 46206
07263	Fairchild, Mountain View, CA 94040	25289	E&G, Bedford, MA 01730	74545	Hubbell, Stratford, CT 06497	90303	Mallory Bar., Tarrytown, NY 10591
07387	Bircher, N. Los Angeles, CA 90032	26601	Tri-County Tube, Nunda, NY 14517	74861	Industrial Cndsr., Chicago, IL 60618	90534	Gulton Inds., Metuchen, NJ 08840
07595	Amer Semicond., Arlington Hts, IL 60004	26805	Omn Spectra, Waltham, MA 02154	74868	Amphenol, Danbury, CT 06810	90750	Westinghouse, Boston, MA 02118
07699	Magnetic Core., Newburgh, NY 12550	26806	American Zettler, Costa Mesa, CA 92626	74970	Johnson, Waseca, MN 56093	90952	Hardware Prod., Reading, PA 19602
07707	USM Fastener, Shelton, CT 06484	27014	National, Santa Clara, CA 95051	75042	IRCI TRW, Burlington, IA 52601	91032	Continental Wire, York, PA 17405
07828	Bodine, Bridgeport, CT 06605	27545	Hartford Universal Bull., Rocky Hill, CT 06087	75376	Kurz-Kasch., Dayton, OH 45401	91146	Cannon, Salem, MA 01970
07829	Bodine Electrc., Chicago, IL 60618	28480	HP, Palo Alto, CA 94304	75382	Kuka, Mt Vernon, NY 10551	91210	Gerber, Mishawaka, IN 46544
07910	Cont Devis., Hawthorne, CA 90250	28520	Heyman Mfg., Kenilworth, NJ 07033	75491	Lafayette, Syosset, NY 11791	91293	Johnson, Boonton, NJ 07005
07983	State Labs., New York, NY 10003	28875	IMC Magnetics, Rochester, NH 03867	75608	Linden, Providence, RI 02905	91417	Harris, Melbourne, FL 32901
07999	Borg Inst., Delavan, WI 53115	28959	Hoffman Electcs., El Monte, CA 91734	75915	Litelford, Des Plains, IL 60016	91506	Augit Bros., Attleboro, MA 02703
08524	Beif Electrc., Los Angeles, CA 90045	30043	Solid State Devis., LaMirada, CA 90638	76006	Lord Mfg., Erie, PA 16512	91598	Chandler, Westfield, CT 06109
08556	Bell Electrc., Chicago, IL 60632	30646	Backman Inst., Cedar Grove, NJ 07009	76149	Mallory Electrc., Detroit, MI 48204	91637	Dale Electrc., Columbus, ME 58901
08730	Vaseline Prod., Franklin Lakes, NJ 07471	30674	IBM, Armonk, NY 10604	76241	Milco, Chicago, IL 60616	91688	Eco, Willow Grove, PA 19090
09213	GE, Buffalo, NY 14220	30985	Pergas Magnetics., Toledo, OH 43609	76381	3 M Co., St. Paul, MN 55101	91719	General Inst., Dallas, TX 75220
09353	C&K Components, Watertown, MA 02172	31019	Solid State Scntific., Montgomery, PA 18936	76385	Minor Rubber, Bloomfield, NJ 07003	91836	Kings Electcs., Tuckahe, NY 11223
09408	Star-Tronics, Georgetown, MA 01830	31514	Standford Appld Eng., Costa Mesa, CA 92626	76487	Millen, Malden, MA 02148	91916	Mephisto Tool, Weymouth, NY 12534
09823	Burgess Battery, Freeport, IL 61032	31814	Analogic., Wakefield, MA 01880	76545	Mueller Electr., Cleveland, OH 44114	91929	Honeywell, Freeport, IL 61032
09856	Fenwal Electrs., Framingham, MA 01701	31951	Tridex., Pittsburgh, PA 15231	76684	National Tube., Pittsburgh, PA	92519	Electra Insul., Woodside, NY 11377
09922	Burdny., Norwalk, CT 06852	32001	Jensen, Chicago, IL 60638	76854	Oak Inds., Crystal Lake, IL 60014	92768	Edderton Germeshusen, Boston, MA 02115
10025	Glasseal Prod., Linden, NJ 07036	33095	Spectrum Control., Fairview, PA 16415	77132	Dot Fastener, Waterbury, CT 06720	92872	IMC Magnetics, Westbury, NY 11591
10389	Chicago Switch, Chicago, IL 60647	33173	GE, Owensboro, KY 42301	77147	Patton MacGuy., Providence, RI 02905	92970	Amperx, Redwood City, CA 94063
11236	CTS of Berne, Berne, IN 46711	34141	Koehler, Marlboro, MA 01752	77166	Pearce Roberts Rubber., Trenton, NJ 08638	92966	Hudson Lamp, Kearny, NJ 07032
11599	Chandler Evans, W. Hartford, CT 06101	34156	Semco., Costa Mesa, CA 92626	77263	Plant Bros. Rubber, CT 06720	93332	Sylvania, Woburn, MA 01801
11983	Neuronics, Minneapolis, MN 55427	34333	Silicon Genrl., Westminster, CA 92683	77315	Positive Lockwater., Newark, NJ	93346	Amer Electcs Labs., Lansdale, PA 19446
12040	National, Santa Clara, CA 95051	34335	Advanced Micro Devis., Sunnyvale, CA 94086	77329	AMF, Princeton, IN 47570	93618	R&C Mfg., Ramsey, PA 16671
12045	Electrc Transistors, Flushing, NY 11354	34649	Intel., Santa Clara, CA 95051	77342	AMF, Princeton, IN 47570	93916	Cramer, New York, NY 10013
12498	Teledyne, Mountain View, CA 94043	34677	Soliton Devis., Jupiter, FL 33458	77542	Ray-o-Vac, Madison, WI 53703	94144	Raytheon, Quincy, MA 02169
12617	Hamlin, Lake Mills, WI 53551	35929	Constans, Montreal, QUE, CAN	77630	TRW, Camden, NJ 08103	94154	Wagner Electrc., Livingston, NJ 07039
12672	RCA, Woodbridge, NJ 07095	36462	National Ltd., Montreal, QUE, CAN	77638	General Inst., Brooklyn, NY 11211	94271	Weston, Archibald, PA 18403
12697	Cloarostat, Dover, NH 03820	37942	Mallory, Indianapolis, IN 46206	78189	Shakproof., Elgin, IL 60120	94422	Tel Labs., Manchester, NH 03102
12856	Micrometals., City of Industry, CA 91744	38443	Marlin Rockwell, Jamestown, NY 14701	78277	Sigma Inst., Braintree, MA 02184	94538	Dickson, Chicago, IL 60619
12954	Dickson Electrs., Scottsdale, AZ 85252	39317	McGill Mfg., Valparaiso, IN 46383	78429	Airco Spear., St. Marys, PA 15867	94696	Magnecraft, Chicago, IL 60630
12969	Unirode, Watertown, MA 02172	40931	Honeywell, Minneapolis, MN 55408	78488	Stackpole, St. Marys, PA 15867	94800	Atlas Ind., Brookline, NH 03033
13094	Electrocraft, Hopkins, MN 55343	42190	Muter, Chicago, IL 60638	78553	Tinnerman, Cleveland, OH	95076	Garde, Cumberland, RI 02964
13103	Thermally, Dallas, TX 75234	42498	National, Metros, MA 02176	78553	Telephonics, Huntington, NY 11743	95121	Dale Electrc., Columbus, ME 58901
13148	Vogue Inst., Richmond Hill, NY 11418	43334	New Departure Hyatt., Sandusky, OH 44870	78989	RCA, Harrison, NJ 07029	95146	Alco Electcs., Lawrence, MA 01843
13150	Vernitron, Lacona, NH 03246	43991	Norma Hoffman, Stanford, CT 06904	79136	Waldes Kohnoor, New York, NY 11011	95238	Continental Conn., Woodside, NY 11377
13327	Soliton Devis., Tappan, NY 10983	49671	RCA, New York, NY 10020	79497	Western Rubber, Goshen, IN 46526	95275	Vitramon, Bridgeport, CT 06601
13715	Fairchild, San Rafael, CA 94903	49956	Raytheon, Waltham, MA 02154	79725	Wiremod., Hartford, CT 06110	95348	Gordos, Bloomfield, NJ 07003
13919	Burr Brown, Tucson, AZ 85706	50088	Mostek, Carrollton, TX 75006	79727	Continental Wirt., Philadelphia, PA 19101	95354	Methode., Rolling Meadow, IL 60008
14010	Anadex Inst., Van Nuys, CA 91406	50101	GHZ Devis., S. Chelmsford, MA 01824	79840	Mallory Controls, Franklin, IN 46041	95794	Amer Brass., Torrington, CT 06790
14195	Elctrc Controls, Wilton, CT 06897	50507	Micro Networks., Worcester, MA 01606	79863	Zierick, Mt Kisco, NY 10549	95987	Weckesser, Chicago, IL 60646
14196	American Labs., Fullerton, CA 92634	50522	Monsanto, Palo Alto, CA 94304	80009	Tektronix., Beaverton, OR 97005	96095	Aerovox Hr. Q., Olean, NY 14760
14332	Retrum, Arcadia, CA 91006	50721	Datel Systems, Canton, MA 02021	80030	Prestolite Fastener, Toledo, OH 43605	96341	Microvex Assoc., Burlington, MA 01801
14433	ITT, W. Palm Beach, FL 33402	51167	Arnes Electcs., Franchtown, NJ 08825	80048	Vickers, St. Louis, MO 63166	96906	Military Standards
14482	Harkins & Johnson, Palo Alto, CA 94304	51553	Diablo Systems, Hayward, CA 94545	80103	Lambda, Melville, NY 11746	97919	Lynemaster Switch, Woodstock, CT 06281
14608	Corbin, Berlin, CT 06037	51642	Centre Eng., State College, PA 16801	80133	Sprague, N. Adams, MA 01247	98291	Sellectro, Mamaroneck, NY 10544
14655	Cornell Dubilier, Newark, NJ 07101	52648	Plessee, Santa Ana, CA 92705	80211	Motorola, Franklin Pk., IL 60131		